Coalesse Seating/ Occasional Tables Specification Guide

Availability

Electronic price list updated with release 178.F (U.S.) and 145.F (Canada), dated February 17, 2014.

Transitional products in this specification guide are **maintained for existing customers only** and are likely to be phased out over time. These products are indicated with a **†**. Products that are scheduled to be culled are indicated with an **✕**, followed by the last order entry date.

General Information

Locations	2
Warranty	3
Ordering	4
Sustainability	6
SCS Certifications	7
Design Awards	8
Designers	9

Seating/Occasional Tables	13
Lounge Seating	53
Guest/Side/Stack Seating	235
Executive Seating	293
Occasional Tables	307
Indoor/Outdoor Seating	371

Resources	393
------------------	------------

► For a list of all trademarks, refer to the last page of this specification guide.



For Canadian Pricing

Calculate in the following order to avoid rounding errors:

- Multiply the base price and each option by 1.03.
- Round each to the nearest dollar.
- Add base and options for total list price.

6 Locations



MAIN TELEPHONE 866.645.6952
CUSTOMER SERVICE 1.800.627.6770

Showrooms

- 1 Chicago, IL**
222 Merchandise Mart, Suite 1032
Chicago, IL 60654
TEL 312.467.1783

- 2 Grand Rapids, MI**
901 44th Street SE
Grand Rapids, MI 49508
TEL 616.246.4000

- 3 New York, NY**
4 Columbus Circle, 7th Floor
New York, NY 10019
TEL 212.445.8989

- 4 Los Angeles, CA**
1217 2nd Street
Santa Monica, CA 90401
TEL 310.633.2200

- 5 High Point, NC**
250 Swathmore Avenue
High Point, NC 27263
TEL 336.434.4151

- 6 Mexico**
Steelcase, Mexico
Blvd. Manuel Avila Camacho #24
Piso11, Col. Lamas de Chapultepec
11000 Mexico D.F., Mexico
TEL 011.52.555.540.9916

Offices

- 7 San Francisco, CA**
Coalesse Design Center
660 Third Street, Suite 100
San Francisco, CA 94107
TEL 415.486.6340

This specification guide is published for domestic use only. For export pricing and information concerning the shipment of Coalesse products outside North America, please contact Customer Service. Prices and data subject to change without notice and are shown in U.S. dollars.

Warranty

Warranty

This warranty applies to Coalesse products delivered in the United States, Canada, Mexico, Latin America, and the Caribbean.

Coalesse, a division of Steelcase Inc. ("Coalesse"), warrants that Coalesse, Brayton, Metro and Vecta brand commercial products are free from defects in materials or workmanship, for a period of (10) years, subject to the exceptions listed below. Coalesse will repair or replace with comparable product, at its option and free of charge, any product, part or component manufactured after November 16, 2009 that fails under normal use as a result of such defect. This warranty applies from the date of manufacture, regardless of shift usage and is valid only for the original purchaser.

Exceptions

Lifetime

All interior wood frames

5 years

Stacking chairs, wood veneer, metal chair frames, functional mechanisms such as dollies, carts and trolleys, seating components including controls, adjustment mechanisms, pneumatic cylinders, and tablet arm assemblies. For Emu outdoor frames warranty applies against invasive and perforating rust not deriving from scratches or abrasions due to use and which cannot be removed by normal cleaning and care.

3 years

High wear parts such as casters and glides, stocked fabrics and other stocked covering materials. For all fabrics and leathers (DesignTex, Maharam, Luna, etc) originating manufacturer warranties apply.

2 years

Exposed wood frames.

1 year

Marker boards, electrical components (including task lights, power strips, harnesses, power blocks, outlets, data connectors, audio and video connectors and all tabletop devices), drawer and door mechanisms, keyboard supports, fiberglass panels, replacement parts, granite and glass top surfaces, and outdoor cushions.

Exclusions

This warranty does not apply to product failure resulting from:

- Normal wear and tear
- Failure to apply, install, or maintain products according to published Coalesse instructions and guidelines
- Abuse, misuse, or accident
- Alteration or modification of the product
- The substitution of any unauthorized non-Coalesse components for use in the place of Coalesse components in an integrated product solution; such substitute components include but are not limited to worksurfaces, leg supports, panels, brackets, shelves, overhead bins, and other integral components.

The following products and materials are not covered by this warranty:

- Products considered consumables (e.g. lamps),
- Customer's Own Material (COM) or non-standard textiles and materials
- Variations occurring in surface materials (e.g. color fastness or matching grains, textures, and colors across dissimilar substrates and lots)
- Other manufacturer's products, including Carl Hansen and Emu. Coalesse will pass through other manufacturer's warranties where applicable and to the extent possible.

THIS LIMITED WARRANTY IS THE SOLE REMEDY FOR PRODUCT DEFECT AND NO OTHER EXPRESS OR IMPLIED WARRANTY IS PROVIDED, INCLUDING BUT NOT LIMITED TO ANY IMPLIED WARRANTIES OF MERCHANTABILITY OR FITNESS FOR A PARTICULAR PURPOSE. COALESSE SHALL NOT BE LIABLE FOR CONSEQUENTIAL OR INCIDENTAL DAMAGES ARISING FROM ANY PRODUCT DEFECT.

Ordering

How to Order

Coalesse furniture is available through authorized dealers and retailers. Select products are available for order from our web site. The authorized dealer can help you with everything from surface material selection and order placement, to specialized services, such as space planning and design, delivery and installation. Best of all, they are part of your local community, providing expert advice with a thorough understanding of local needs. For more information and a listing of dealers and retailers, visit www.coalesse.com or call 1.800.627.6770.

Coalesse reserves the right to limit distribution of any or all models.

Credit, Prices, and Terms

Credit may be established upon acceptance of satisfactory references. For payment terms, contact Coalesse's Credit Department. Coalesse may cancel or change credit terms at its discretion and may request advance payment at any time.

The order confirmation will be deemed by the customer and by Coalesse, as the final expression of agreement and will be deemed the exclusive statement of terms. The order confirmation supersedes all prior writings and may not be modified or rescinded, except by a revised Coalesse order confirmation signed by the customer. No changes are binding on Coalesse until delivery of the order confirmation. Any storage charges and applicable sales taxes are in addition to the prices shown for merchandise. Inside delivery, uncartoning and installation are customer's responsibility unless separately quoted. All list pricing shown includes freight prepaid to one destination for delivery in the 48 contiguous United States. Hawaii and Alaska are not included. We reserve the right to increase prices without notice due to increases in labor and material costs. If timely payment is not made, customer is liable for reasonable collection costs, including attorney's fees.

Shipping and Storage

Coalesse reserves the right to select carrier and packaging method. Partial shipments may be delivered. Coalesse is not liable for delays or delivery failure due to strikes, lockouts, labor, or transportation difficulties, failure or delay of supply sources, accidents, fire, acts of God, or any other cause of like or unlike nature beyond Coalesse's control. Coalesse may transfer merchandise to storage if not accepted when shipment scheduled. Transfer and storage charges will be the customer's expense. Coalesse's invoice is payable upon transfer. If transfer is made prior to confirmed shipping date, storage expenses will be borne by customer.

Shipping charges MAY be calculated per order. Lead-times vary by product. Coalesse reserves the right to select carrier. Partial shipments may be delivered. Coalesse will make every effort to provide current and accurate lead-time information, however, Coalesse is not liable for delays or delivery failure due to strikes, lockouts, labor, or transportation difficulties, failure or delay of supply sources, accidents, fire, acts of God, or any other cause of like or unlike nature beyond Coalesse's control.

Freight is included on domestically manufactured products within the 48 contiguous states of the United States and standard freight service of Carl Hansen & Søn and Emu.

Claims

Merchandise shipped from Coalesse is thoroughly inspected and properly packed before leaving the factory. Responsibility of its safe delivery is assumed by the carrier at the time of shipment. Customer must match the freight delivered with the bill of lading. Customer must examine packaging material upon delivery and note any damage on the carrier bill of lading. If there is damage to the packaging material, inspect the furniture immediately. If concealed damage is found, contact the carrier within 10 days of delivery date. Save all packaging materials until after inspection.

Freight damage and claims must be reported by the purchaser to the carrier. Coalesse is not responsible for freight claims. Claims for loss or damage must not be deducted from our invoice, nor payment withheld awaiting adjustment of such claims. Do not return any merchandise to Coalesse without a Return Authorization number. By following these procedures carefully, Coalesse guarantees our full support of your claims to protect you against loss or damages. All claims against Coalesse for defects, errors or shortages must be made by customer in writing within ten (10) days after delivery. Failure to make claims within ten (10) days constitutes acceptance of merchandise and waives claims. Cutting of textiles deems acceptance of yardage and waives all defects, errors, and shortages. Coalesse is not liable for subsequent damages.

Special/Custom Products

Coalesse prides itself on being responsive to our customer's needs. Contact our customer service team at 1.800.627.6770 to discuss a special opportunity. Due to product modifications and engineering time, special orders may not be cancelled. Charges will apply.

FOR MORE INFORMATION (on ordering our products)

Please contact Coalesse Customer Service at: 1.800.627.6770 .

Ordering

Order Cancellations/ Changes

All order change/cancellation requests must be submitted using the Coalesse order change/cancellation request form. Late changes could jeopardize the committed delivery of an order.

Coalesse Rapid10 programs no change or cancellations allowed.

Coalesse Products:

- No charges will be assessed for change or cancellation 14 or more calendar days prior to the manufacturing completion date (excludes holidays and/or large quantity project size orders). For import products, charges may apply.

- No manufacturing changes are allowed 0-13 calendar days prior to the manufacturing completion date. Simple changes including shipping address changes are subject to approval but will be accommodated when possible.

- No cancellations or product changes will be accepted for quick ship or special/custom product orders including special laminates. A cancellation fee will be applicable for any custom product and/or change may jeopardize lead time.

- If COM/COL has been received at time of change or cancellation, it is the dealer's responsibility to advise disposition or return of materials. Coalesse will not store materials after 30 days.

Additional Charges

- Changes or cancellations that involve any of the following may be subject to a charge earlier and/or greater than shown above: Special engineering product, CSM, pre-ordered components, materials with extended lead times (e.g., veneers, special paint, etc.) or large quantities of standard materials.

- Use our Order Change/Cancellation Request Form for all order changes. It is Coalesse responsibility to accurately process change order requests. It is the dealer's responsibility to verify that we have accurately interpreted your change requests by checking the acknowledgement after the change has been made. If you do not use the web-based change order form process and an error occurs during our translation which cannot be corrected prior to ship, all costs will be shared on a 50/50 basis. Changing ship dates or adding product to your order is subject to the availability of manufacturing capacity.

- Cartoning changes and shipping address changes are subject to approval and to a change charge. Please consult your Customer Service for specific information pertaining to your order.

Reserved Fabric Policy

Prior to order receipt, reserving textiles (COM/COL, Maharam, Designtex, and select Luna Graded-In) is the responsibility of the dealer. Coalesse cannot reserve textiles based on projected orders. Coalesse cannot guarantee Maharam or Designtex fabric availability. If dealer reserves Maharam or Designtex textiles, Coalesse will require the reserve number and zip code for locating purposes when ordering.

Schedule Enhancements

Coalesse will entertain schedule enhancements on a case-by-case basis; however, please understand that we must receive complete information such as installation date, opening date etc...to make informed scheduling decisions.

No order move-ups or move-outs are allowed on any order that falls within the 15-working day period of its manufacturing completion date. If it is within the 15-working day period, Coalesse will invoice at shipment but may offer storage options at a charge for manufactured product.

Sustainability

As our understanding of sustainability evolves in the contract furniture business, Coalesse is being launched on three important fronts: responsibly harvested woods, better ways of plating metal, and manufacturing for the highest level of durability. To ensure all new products are socially responsible, we have engaged the "cradle-to-cradle" design consultancy, MBDC, to advise us and provide third-party analysis of the materials and processes we use to create our products. As Coalesse grows, social responsibility will be an essential part of our decision-making, from design to disposal. We believe that our success on the environmental front will be built on the accumulation of a multitude of small steps and the occasional big leap. We are starting with a green outlook and we have every intention of growing greener.

WOODS: FSC CERTIFICATION

Our policy with wood sourced from outside North America and our approved European partners is that they must be certified by The Forestry Stewardship Council (FSC) to ensure these woods have been responsibly harvested from sustainable forests, and that the rights and welfare of workers and local communities are being respected. Through an FSC label, wood can be traced back to its original source of supply.

Our Geneva, NY manufacturing location has chain of custody certification for working with FSC certified woods.

CHROME: A NEW ALTERNATIVE TO METAL

Chromed steel is a mainstay of the contract furniture industry because it is considered a premium finish with high durability. But depending on the type of chrome processing used, it can have a detrimental impact on human and environmental health. The most common method of chrome plating uses hexavalent chrome, a known carcinogen and considered by MBDC in their color-coded rating system (green, yellow, red), to be a "hard-red" chemical. There are no health hazards associated with chrome once it has been applied, but the hexavalent chrome electroplating process can be hazardous.

Is there an alternative? Coalesse is opting for a safer method of plating and has partnered with a domestic supplier who uses only "trivalent" chrome, a non-carcinogenic form of the metal. Few, if any, metal finishing processes are without environmental challenges, and chrome is no exception. Working with the best technology currently available, we will continue to seek new and better alternatives.

BUILDING TO LAST

Building longevity into products is an important sustainability strategy. A chair or table that lasts for 50 or 100 years or more will not have to be replaced, saving the materials and finishes and embodied energy from being duplicated in another form. Coalesse is quality furniture designed to outlast its buyers. We hold up Hans Wegner designs as the model of longevity—pieces manufactured a generation ago are still prized possessions today. Our hope is that every piece in our collection appreciates in value over the years, so it will be passed on.

ONGOING AUDITS

As the Coalesse collection grows, our intention is to live by the cradle-to-cradle (C2C) philosophy described by MBDC this way: "Instead of designing cradle-to-grave products, dumped in landfills at the end of their 'life,' the goal is create products for cradle-to-cradle cycles, whose materials are perpetually circulated in closed loops. Maintaining materials in closed loops maximizes material value without damaging ecosystems." Coalesse has contracted MBDC to audit the materials used in the majority of our existing products, and to advise us as we develop new products. We intend to achieve Cradle to Cradle certification on the highest percentage of products possible. As Coalesse grows, social responsibility will be an essential part of our decision-making, from design to disposal. We believe that our success on the environmental front will be built on the accumulation of a multitude of small steps and the occasional big leap. We are starting with a green outlook and we have every intention of growing greener.

SCS Certifications

Consolidated List, as of November, 2009

Seating

Guest

- Kart Café
- Kart Stack
- Enea (All models)
- Last Minute Stool
- Lottus
- Bindu

SCS Indoor Advantage Gold Indoor Air Quality Certified to SCS-EC10.2-2007
Conforms to ANSI/BIFMA Furniture Emissions Standard (M7.1/X7.1-2007) for the open plan and private office scenarios: California Specification 01350 for the open plan and school classroom scenarios and BIFMA e3-2008 (Credit 7.6.1 and 7.6.2) for the open plan and private office scenarios. Registration: SCS-IAQ-01822

Guest - Wood

- Capa
- Switch Guest
- Wrapp

SCS Indoor Advantage Gold Indoor Air Quality Certified to SCS-EC10.2-2007
Conforms to ANSI/BIFMA Furniture Emissions Standard (M7.1/X7.1-2007) for the open plan and private office scenarios: California Specification 01350 for the open plan scenario and BIFMA e3-2008 (Credit 7.6.1 and 7.6.2) for the open plan and private office scenarios. Registration: SCS-IAQ-02305

Stack Seating

- Andoo
- Kathryn

SCS Indoor Advantage Indoor Air Quality Certified to SCS-EC10.2-2007
Conforms to ANSI/BIFMA Furniture Emissions Standard (M7.1/X7.1-2007) and BIFMA e3-2008 (Credit 7.6.1 and 7.6.2) for the open plan and private office scenarios. Registration: SCS-IAQ-01823

Executive - Task

- Bob
- Chord
- Bindu
- La Costa
- Rocky (all models)
- Maestro

SCS Indoor Advantage Gold Indoor Air Quality Certified to SCS-EC10.2-2007
Conforms to ANSI/BIFMA Furniture Emissions Standard (M7.1/X7.1-2007) for the open plan and private office scenarios: California Specification 01350 for the open plan and school classroom scenarios and BIFMA e3-2008 (Credit 7.6.1 and 7.6.2) for the open plan and private office scenarios. Registration: SCS-IAQ-01824

Lounge (Gold)

- Astor
- Await
- Circa
- Coupe
- Davos
- Evaneau
- Herren
- Holy Day
- Joel
- Ripple
- Sidewalk (includes mobile)
- Stilleto
- Swathmore (includes Grande and Grande Mobile)
- Switch chair
- Switch lounge
- Thoughtful
- Together

SCS Indoor Advantage Gold Indoor Air Quality Certified to SCS-EC10.2-2007
Conforms to ANSI/BIFMA Furniture Emissions Standard (M7.1/X7.1-2007) for the open plan and private office scenarios: California Specification 01350 for the open plan and school classroom scenarios and BIFMA e3-2008 (Credit 7.6.1 and 7.6.2) for the open plan and private office scenarios. Registration: SCS-IAQ-01820

Lounge

- Archipelago
- Bix
- Club
- Detour
- Pasio
- Passerelle
- Topo

SCS Indoor Advantage Indoor Air Quality Certified to SCS-EC10.2-2007
Conforms to ANSI/BIFMA Furniture Emissions Standard (M7.1/X7.1-2007) and BIFMA e3-2008 (Credit 7.6.1) for the open plan and private office scenarios. Registration: SCS-IAQ-01820

Tables

- Akira
- Au Lait
- Ballet
- Derby
- Disc
- E-table
- Ginkgo Biloba
- Juice
- Reunion
- Rizzi Arc
- Runner (including TR)
- Teamwork Auxiliary Table
- Train

SCS Indoor Advantage Indoor Air Quality Certified to SCS-EC10.2-2007
Conforms to ANSI/BIFMA Furniture Emissions Standard (M7.1/X7.1-2007) and BIFMA e3-2008 (Credit 7.6.1) for the private office scenario only. Registration: SCS-IAQ-02272

Tables (Excludes Wood or Wood Veneer, for laminates only):

- Akira
- Arriva
- Au Lait
- Ballet
- Derby
- E-table
- Ginkgo Biloba
- Juice
- Reunion
- Rizzi Arc
- Runner (including TR)
- Teamwork Auxiliary Table
- Train

SCS Indoor Advantage Gold Indoor Air Quality Certified to SCS-EC10.2-2007
Conforms to ANSI/BIFMA Furniture Emissions Standard (M7.1/X7.1-2007) for the open plan and private office scenario. Also conforms to BIFMA e3-2008 (Credit 7.6.2) for the private office scenario only. Registration: SCS-IAQ-01844

Systems Furniture

(Includes all wood options except wood fronts on storage for the open plan scenario)
Teamwork Tables, Storage Carts, Mobile Easel and Wall Mounted Markerboards, Detour Mobile Desk, Café Tables, T-Screens, Moped and Stations, and Topo (excludes seating)

SCS Indoor Advantage Indoor Air Quality Certified to SCS-EC10.2-2007
Conforms to ANSI/BIFMA Furniture Emissions Standard (M7.1/X7.1-2007) for the open plan and private office scenarios. Also conforms to BIFMA e3-2008 (Credit 7.6.1) for the open plan and private office scenario. Registration: SCS-IAQ-01844

Casegoods

- Denizen

SCS Indoor Advantage Indoor Air Quality Certified to SCS-EC10.2-2007
Conforms to ANSI/BIFMA Furniture Emissions Standard (M7.1/X7.1-2007) for the private office scenario only and BIFMA e3-2008 (Credit 7.6.1) for the private office scenario only. Registration: SCS-IAQ-01842

Design Awards Since 1991

2013 IF Design Award	Hosu
2013 Red Dot Design Award – Product Design	Hosu
2012 Editor's Choice	Free Stand
2012 Innovation Award	Free Stand
2012 Silver Award	Free Stand
2011 Best of NeoCon Gold	Sebastopol
2011 Best of NeoCon Silver	CG_1
2010 Best of NeoCon Innovation	SW_1
2010 Best of NeoCon Silver	Topo Freestanding
2009 IDEA Bronze Award	Akira
2009 Best of NeoCon Gold	Denizen
2009 Best of NeoCon Silver	Emu Heaven
2008 Good Design Award	Andoo
2008 Good Design Award	Holy Day
2007 Best of NeoCon Gold and Silver	Akira
2006 Good Design Award	Await
2006 Best of NeoCon Gold, Roscoe Merit Award	X-Stack
2005 Adex Platinum	Calm
2005 Adex Platinum	Ripple
2005 Best of NeoCon Silver	Rocky
2005 Adex Silver	Thoughtful
2005 Good Design Award, Adex Platinum, ID Magazine - Design Distinction	Topo
2004 Adex Gold	Bix Expansion
2004 Best of NeoCon Gold	Calm
2004 Good Design Award	Ripple
2004 Best of NeoCon, Best of Competition Gold	Topo
2003 Best of NeoCon Gold	Au Lait
2004 Best of NeoCon Gold, Bronze - Arido Award of Excellence	Bix Expansion
2002 Silver - Arido Award of Excellence	Bix
2002 Best of NeoCon Gold	Kart Café
2002 Best of NeoCon Silver	E-Table
2001 Best of NeoCon Gold, Silver, and most Innovative	Bix
2000 Best of NeoCon Gold	Diekman Tables
2000 Best of NeoCon Gold, Best of NeoCon Editor's Choice	Sidewalk
2000 Best of NeoCon Silver	TeamWork
2000 Best of NeoCon Gold	Train
2000 Adex Platinum	TX

1999 Best of NeoCon Silver, Adex Award	Detour
1999 Best of NeoCon Gold and Most Innovative, IDSA Design of the Decade, IDEA Gold Award, Apex Award, Acclaim Award, Office Insight	Kart
1998 Best of NeoCon Gold and Most Innovative, IDSA Design of the Decade, IDEA Gold Award, Apex Award, Acclaim Award, Office Insight-Most Excellent	Kart
1998 Best of NeoCon Silver	Switch Lounge
1997 IIDA Charles Gelber Award	Reunion
1996 Apex Award	Reunion
1995 Best of NeoCon Gold	Runner
1995 Apex Award	TeamWork
1994 Charles Gelber Award, Apex Award	Reunion
1994 Best of NeoCon Gold	Rizzi Arc
1994 Best of NeoCon - Best of Competition and Gold	Template
1993 IBD Bronze	TeamWork
1992 IBD Best of	Ballet Pedestal
1992 IBD Bronze and Acclaim Award	Evaneau
1991 Roscoe Award, Acclaim Award Best of Show	Ballet

Designers

EOOS - Austria

Andoo/Together

The Austrian-based EOOS was founded in 1995 by Martin Bergmann, Harald Gründl, and Gernot Bohmann, three graduates of the Academy of Applied Arts in Vienna. The partners collaborate on all projects, specializing in the design of furniture, consumer products, and architectural spaces, particularly flagship retail stores. Customers include celebrated names such as Armani, Adidas, Moroso, A1/Vodafone, Matteograssi, Walter Knoll, Keilhauer, Duravit and Zumtobel Staff.

EOOS relies heavily on research and a design process they refer to as "poetic analysis." The partners seek words, sentences, or images that evoke concepts "deeply rooted in mankind."

Says Martin Bergmann: "Our work is not one-dimensional, nor is it based on a direct process that leads from a specific customer requirement to our design. We actually research the context of the customer's brand. What is it derived from? How did the brand myth come about? What does the brand stand for? Our approach frequently enables us to illuminate a previously undiscovered dimension of the customer."

Jeffrey Bennett - USA

Davos Chair & Benches

Jeffrey Bennett, who founded his renowned Studio B in 1995, presented his first collection of furniture and accessories, entitled "Ideas for Production," at the May 1996 International Contemporary Furniture Fair (ICFF) in New York City. The designs won the Editor's Award for "Best Decorative Accessories." At the ICFF in May of 2000, Bennett, along with five other designers, was named "Best New Designer" for work with the U.S. manufacturer, Dune.

Highly versatile, Bennett works in interior architecture, furniture, household products, lighting, fashion accessories, graphic design/corporate image and art direction. He is the first American designer to be hired by a number of major European companies. Recent clients include Authentics, Viccarbe, B&B Italia, Boffi, Cappellini, Dune, Estée Lauder, Hidde/sdb, Michael Kors (LVMH), Ligne Roset, and Troy.

His work has been featured in Abitare, Casa Abitare, Design Diffusion News, Domus, Elle Decor, House & Garden, Interni, Intramuros, Metropolitan Home, The New York Times, Ottagono, and the books "50 Products" and "50 Beds."

In 1995, Bennett founded Consultants for Design Strategy. In collaboration with Nicholas Dodziuk, he consults on custom furnishings and fixtures for clients such as Northwest Airlines, Michael Kors, and Samsonite.

Bennett's explanation of why he designs (Interior Design magazine, December, 2003): "I'm very mechanically inclined, which includes an affinity for and curiosity about machines, industrial process, and materials. I was born with the benefit of being a good three-dimensional thinker, as well as studying a fair bit of business at university. Design was the perfect profession—culture for commerce."

PearsonLloyd - UK

Bob and Lox

Tom Lloyd and Luke Pearson met while studying at England's Royal College of Art in the early 1990's. The London-based PearsonLloyd studio was founded in 1997 based on their shared desire to combine furniture and product design. They work a number of design disciplines, including furniture, consumer products, transport, and the public realm.

The designers have written that their "desire is to produce compelling solutions that are intelligent, appropriate and timeless, and contribute to what for us, is the still embryonic craft of industrial design."

PearsonLloyd's work includes: Virgin Atlantic Airway's Upper Class Suite (2003); a range of walk-in showers for Ideal Standard (2005); a street lighting system by Artemide for The City of Westminster (2004); bus shelters and way-finding system for Sheffield City (2007); and numerous furniture projects for Walter Knoll, Bernhardt Design, Kokuyo, Tacchini, and Allermuir. The studio was selected from over 150 companies to be one of four designated product design consultancies for Transport for London (TFL) until 2009.

Jean-Marie - Massaud-France

Holy Day Lounge & Tables, Emu Heaven

In 2000, Jean-Marie Massaud formed Studio Massaud with Daniel Pouzet. Together, they have designed the Tanabé House (Fukuoka, Japan), Renault's displays at international motor shows, the Modern Object concept store (Columbus, Ohio), the HIP spa (Nice, France), and the brand and architectural image of Lancôme (cosmetics) and Poltrona Frau (furniture) worldwide. Studio Massaud is also working on a 50,000-seat football stadium and two condominium towers (Guadalajara, Mexico), luxury hotel (Paris, France), and a condominium building (Tribeca, New York).

A graduate of Les Ateliers, Ecole Nationale Supérieure de Création Industrielle, Massaud's work, while "humanistic," is rooted in the applied sciences and clearly influenced by his training as an engineer.

Victor Carrasco, General Manager of Viccarbe, says of Massaud: "His unmistakable "Human Nature Style" has allowed him to become, in few years, one of the top designers at international level.

"Who other than Massaud," says Carrasco, "would be able to reinterpret Mies Van Der Rohe in such an elegant and sophisticated way? Only someone with a special sensitivity can develop a landmark collection like Holy Day. It is already a great international bestseller and part of the contemporary history of design."

Massaud's furniture designs are displayed in design museums in Amsterdam, Chicago, London, Lisbonne, Paris, and Zurich.

Marc Krusin

Wrapp Chair

One of Europe's brightest young designers, Marc Krusin is veteran of the Milan-based group Codice 31, which he founded in 1998 with five other designers. He now directs the design team of the prestigious Milanese design firm, Piero Lissoni, overseeing projects for international clients such as Alessi, Kartell, Flos, Thonet, and Wella.

Much of Krusin's own work is done through Klay, a firm he opened in 2004, specializing in "objects of natural materials influenced by world cultures." Cross-cultural influences run throughout his practice.

He has designed for Fontana Arte, Liv'it, Pallucco, Saporiti, Bosa ceramiche, Merten, Omnidector, Glas Italia, and the Spanish furniture firm, Viccarbe. Viccarbe's General Manager, Victor Carrasco, describes Krusin as "a great talent at a very young age."

Krusin was recently honored in the 2008 "Europe 40 Under 40," an annual program co-sponsored by The European Centre for Architecture Art Design and Urban Studies and The Chicago Athenaeum: Museum of Architecture and Design. According to the program directors, Krusin is one of the "next generation of innovative architects and designers who will impact future living and working environments, cities, and rural areas."

Designers *continued*

Patricia Urquiola - Spain

Last Minute Stool, Emu Retrouvé, and Hosu

Patricia Urquiola began training as a student in architecture at Facultad de Arquitectura de Madri before graduating in design from Politecnico di Milano in 1989, where she studied under Achille Castiglione.

In 1991, as head of the product development team at De Padova, Urquiola designed her first commercial furniture pieces (in collaboration with Vico Magistretti). They were highly imaginative yet functionally pragmatic, an appealing combination that has defined her work since.

From 1993 to 1996, Urquiola owned a studio with two friends, accepting commissions in architecture, interiors, showrooms, and restaurants. From 1996 to 2000 she managed the design group Lissoni Associati, then opened her own studio in Milan, focusing on product design, displays, and architecture.

Best known for her many designs for Moroso, Urquiola has also worked for De Padova, Agape, B&B, Alessi, Driade, Foscarini, Kartell, Flos, Molteni, and Artelano among other well-known furniture houses. She has won numerous design awards and is sought after as a speaker at conferences and universities.

Hans J. Wegner - Denmark

Carl Hansen & Son

Hans J. Wegner is one of the 20th century's most important furniture designers. A leader of the Danish Modern style, Wegner is revered for his iconic chairs with their organic beauty and ample comfort. His understanding of wood joinery was unsurpassed, his views on quality uncompromising. Wegner balanced form and function brilliantly.

Carl Hansen & Son, the Danish furniture maker, began working with Wegner in 1949. Among his first designs for the company were the legendary Wishbone Chair (CH24) and several other designs that are still produced today.

During his long career, Wegner designed more than 500 chairs. He almost singularly brought the chair out of its hiding place as "part of a furniture set" and into its own as modern sculpture. He broke new ground by combining natural materials in imaginative ways, always testing the limits of craftsmanship and serial production.

Wegner was demanding and difficult to satisfy, often taking weeks to get the results he wanted from his craftspeople. But he was also limitlessly curious, often playful, and always elegant. "We must take care," he said, "that everything doesn't get so dreadfully serious. We must play - but we must play seriously."

While Wegner was awarded practically every honor possible for a furniture designer, and his chairs are featured in museums around the world, his design is accessible. He believed that chairs were made for sitting. Ergonomics and usability had a central role in his thinking before those words ever entered the mainstream.

Hans J. Wegner died in Denmark in January, 2007.

Brian Kane - USA

Bindu

Brian Kane graduated from the University of Bridgeport, Connecticut, in 1970 with a Bachelor of Science degree in Industrial Design. He worked for several New York City design studios and spent a year in Milan, Italy, working for Architect Silvio Coppola. His projects included the design of seating and case-goods for such companies as Mobil Italia Spa. and Bernini Spa.

After returning to the U.S., he worked in New York for Atelier International (A.I.). Work involved special contract furniture design projects, showroom design, and the startup of U.S. production of Italian designs by Cassina, B&B, and Tecno.

Kane joined the design staff at Metropolitan Furniture Corporation (Coalesse) in January, 1977. Less than three years later, he became one of four partners assuming ownership of the firm, and took on the responsibilities of Vice President of Design and Product Development.

In 1987, Metropolitan was acquired by Steelcase. For the next two years, Kane maintained his position as Vice President and was responsible for all aspects of Coalesse's design, including products, showrooms, and graphics.

In March of 1989, Kane established Kane Design Studio in San Francisco.

Kane's designs have won over 80 design awards and have been exhibited at the Whitney and Brooklyn Museums in New York and the Museum of Modern Art in San Francisco.

WilliamsSorel - USA

Denizen

WilliamsSorel is a California-based design studio established by Otto Williams and Jess Sorel in 2007. Prior to launching their own firm, Otto and Jess were the creative force behind Coalesse, by Steelcase. Their designs for Coalesse won more than 20 awards, most notably for Bix and Topo, two systems, which defied conventional office furniture categories. During their tenure at Coalesse, Otto and Jess developed a passion and reputation for exploring the boundaries between work and life in an effort to humanize the modern workplace.

The designers have said "we are thinking less about categorizing office furniture and residential furniture, and thinking more about the experiences of working and living in spaces, and the artifacts you need to support both narratives simultaneously. There's really a move to allow furniture to be furniture again, as opposed to equipment. In a sense, the office is being dismantled."

Together they hold numerous design and utility patents and their work has been published in Abitare, Azure, Contract, Fast Company, I.D. Magazine, Interior Design, and Metropolis. Otto holds a BFA in Industrial Design from Rhode Island School of Design. Jess holds a BFA in Industrial Design from The California College of the Arts.

Scott Wilson & MINIMAL - USA

SW_1 Collection, Powerpod

In 2007, Scott Wilson founded Chicago-based MINIMAL, a studio whose diverse work spans industries ranging from technology, interaction, and consumer products to fashion, furniture and environments. A former Global Creative Director at Nike, Wilson has led design organizations such as IDEO, Thomson Consumer Electronics, Fortune Brands, and Motorola and created some of the most recognized consumer design icons.

Currently partnering with top Fortune 500 companies such as Google, Dell, Microsoft, Nike, and Xbox as well as exciting start-ups, MINIMAL is working on the some of the most anticipated new devices and experiences in the industry. Balancing consulting for design-centric brands with his intense passion for self-manufacturing and entrepreneurial ventures, Wilson is constantly looking for the next consumer connection. In January of 2010 he successfully incubated, developed, raised funding, and launched a revolutionary new customization platform brand, Uncommon, which took the existing industry giants by surprise.

One of the most respected hands-on designers in the industry, Wilson has the elusive ability to consistently deliver products to market that speak rationally and emotionally to the consumer, ultimately ensuring a higher probability of market success and endurance.

His work has been exhibited in museums and competitions including the Cooper-Hewitt National Design Triennial, MoMA, MCA, and Chicago Athenaeum and has been recognized with over 50 international design awards in the last decade including ID Magazine's Top 40, FastCompany's Master of Design, and TIME Magazine's Style+Design 100.

Designers

Lievore Altherr Molina

Enea Lottus

Lievore Altherr Molina was created in 1991 by the merging of its three partners: Alberto Lievore, Jeannette Altherr, and Manel Molina. Since its founding, the studio has been devoted to product design, consulting, and the art direction of various companies, always offering individualized solutions.

Throughout the years the studio has been recognized for its furniture design, its interior design projects, its products, and packaging. Simultaneously, the studio has developed an intense teaching practice, giving seminars, and training courses to new professionals at various Spanish universities and other organizations.

The studio has been awarded many national and international awards, including Spain's National Design Award in 1999. Lievore Altherr Molina has exhibited their work in Barcelona, Cologne, Chicago, Stockholm, Helsinki, Lisbon, London, Louisiana, Madrid, Malmö, Milan, New York, Paris, and Tokyo. Their ideas and projects are regularly published in the most prestigious design magazines around the world.

Coalesse is excited to introduce the Enea Lottus collection, designed by Lievore Altherr Molina. The Lottus collection of stacking chairs, stools, and tables offers a simple, clean aesthetic to most live/work settings. Easy to store, easy to clean, and user-friendly, the Enea Lottus collection is a logical solution for any environment.

Steven Copeland

Free Stand

Steven Copeland is an industrial designer known for crafting mobility. "I'm looking for new products that free up people's physical aspirations and enable intuitive expression... constructions that gel with the amazing human body and celebrate agility."

Born in 1960 in Montreal, Copeland's kinetic approach to design began as a child making toys and bicycles. Today his professional work is defined by an interactive quality, the way toys are defined by the play they inspire.

With a client list of elite manufacturers in the U.S. and Europe, Copeland has won several of the industry's top awards and has been widely published and exhibited for design innovation. Best known for a groundbreaking collection of lighting with Flos, Steelcase, Knoll, and Luxo, Copeland has built a reputation for creative problem-solving that led to collaborations with NASA and M.I.T., and to work with Rhode Island School of Design and the University of the Arts in Philadelphia, P.A. He has also pioneered new levels of performance in computer ergonomics and disabled cycling.

Seating/Occasional Tables

Statement of Line	14
-------------------	----

Lounge Seating	53
Guest/Side/Stack Seating	235
Executive Seating	293
Occasional Tables	307
Indoor/Outdoor	371

Statement of Line

Lounge Seating

Archipelago Lounge

Understanding
▶ Page 54
Specifying
▶ Page 58

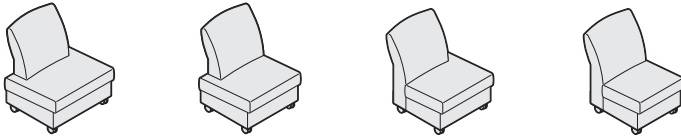

Archipelago Arms and Tablet Arms

Understanding
▶ Page 54
Specifying
▶ Page 59

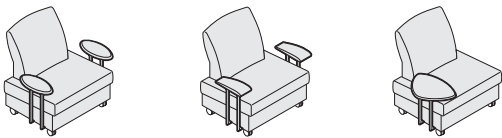

Archipelago Ottoman

Understanding
▶ Page 54
Specifying
▶ Page 60



Astor

Specifying
▶ Page 64

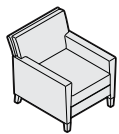

Chair

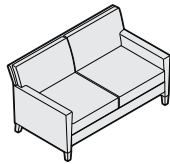

Two-seat Sofa

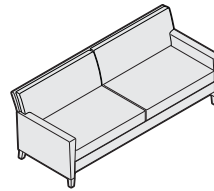

Three-seat Sofa

Await Modular Seating

Specifying
▶ Page 66

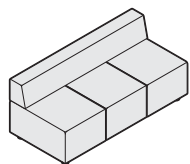

Three-seat Sofa

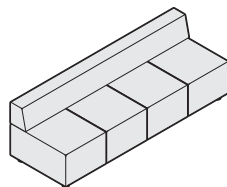

Four-seat Sofa

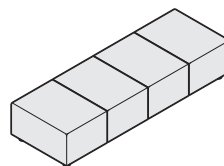

Four-seat Bench



Mobile Ottoman

Lounge Seating, continued

Await Connector Benches

Specifying
▶ Page 68

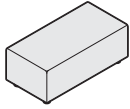

One-section Connector

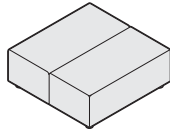

Two-section Connector

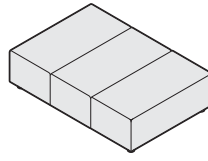

Three-section Connector

Bix Lounge

Understanding
▶ Page 72
Specifying
▶ Page 82

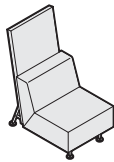
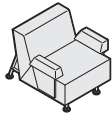

Bix Sled Lounge

Understanding
▶ Page 72
Specifying
▶ Page 83

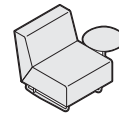
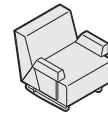
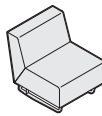

Bix Sectional Seating

Understanding
▶ Page 72
Specifying
▶ Page 84

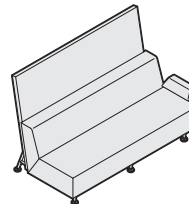
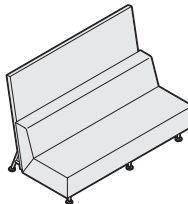
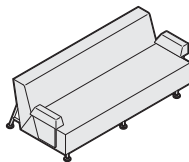
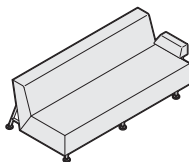
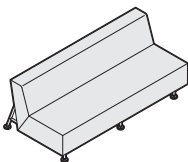
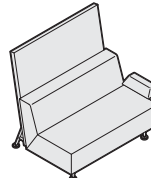
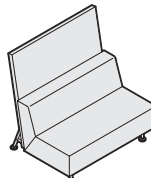
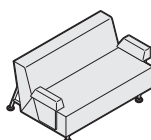
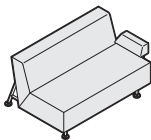
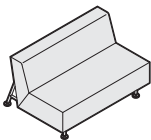
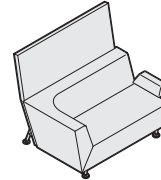
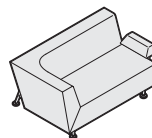
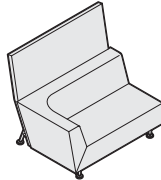
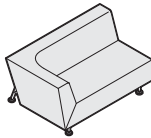
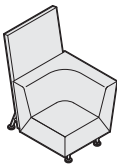

Lounge Seating, continued

Bix Benches

Understanding
▶ Page 72
Specifying
▶ Page 90

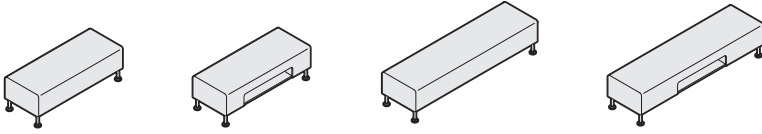

Bix Podium

Understanding
▶ Page 72
Specifying
▶ Page 92

Bix Service Tray

Understanding
▶ Page 72
Specifying
▶ Page 97

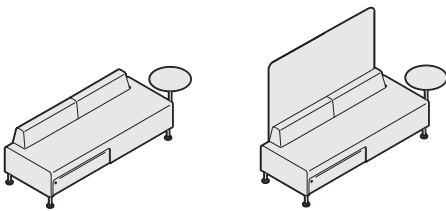

Bix Bridge Tables

Understanding
▶ Page 72
Specifying
▶ Page 98

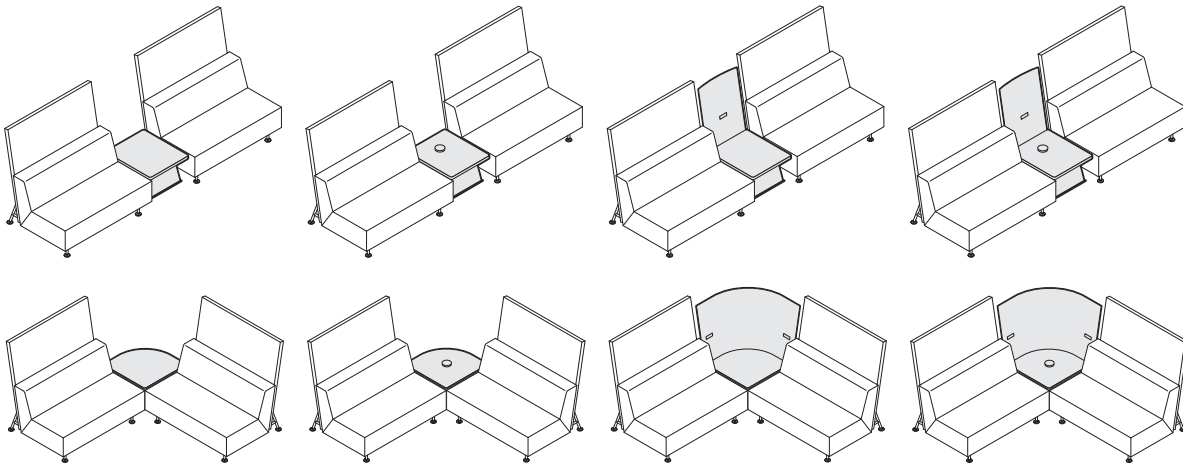

Bix 27"H Work-Booth Tables

Understanding
▶ Page 72
Specifying
▶ Page 101

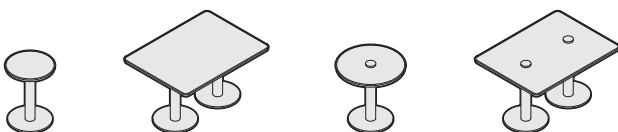

Lounge Seating, continued

Bob Chairs

Specifying
▶ Page 103



Lounge Swivel



Lounge with
Headrest



Ottoman

CH07 Shell Chair

Specifying
▶ Page 104



CH25 Paddle Chair

Specifying
▶ Page 105



CH44 Ladderback Chair

Specifying
▶ Page 106



CH100 Series

Specifying
▶ Page 107

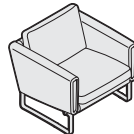

Club Chair

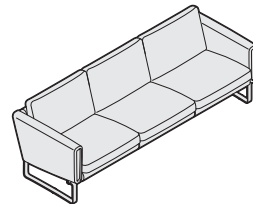

Sofa

CH401 Airport Chair

Specifying
▶ Page 108



CH445 Wing Chair and Ottoman

Specifying
▶ Page 109

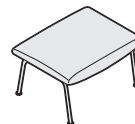

Lounge Seating, continued

Circa Modular Seating

Specifying
▶ Page 110

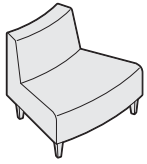

30° Outside/Inside
Facing Wedge Seat

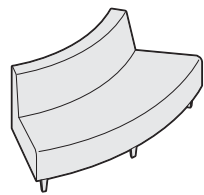
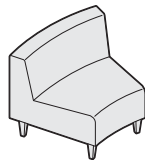

60° Wedge Loveseat

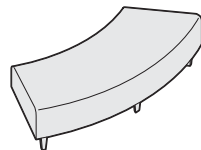
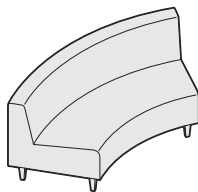

Wedge Bench

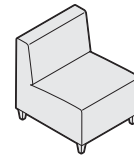
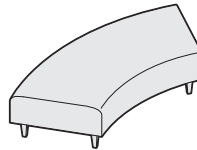

Straight Seat Chair

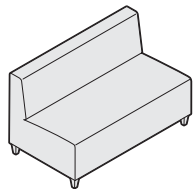

Straight Loveseat

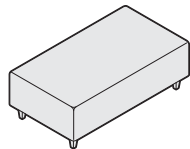

Straight Bench

Circa Modular Armrests

Specifying
▶ Page 114



Straight Armrest
Intermediate without
Legs

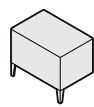

Straight Armrest
End-of-Run with Two Legs



15° Inside Armrest
Intermediate without Legs

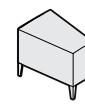

15° Inside Armrest
End-of-Run with Two Legs



15° Outside Armrest
Intermediate without Legs

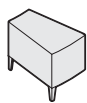

15° Outside Armrest
End-of-Run with Two Legs

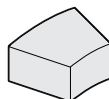

30° Inside Armrest
Intermediate without Legs

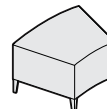

30° Inside Armrest
End-of-Run with Two Legs

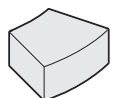

30° Outside Armrest
Intermediate without Legs

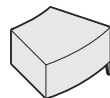

30° Outside Armrest
End-of-Run with Two Legs

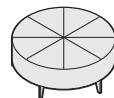

Round Ottoman

Statement of Line

Lounge Seating, continued

Circa Ganging Tables

Specifying
► Page 120

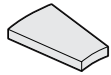

Low Wedge Table

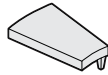

End-of-Run Low Wedge Table

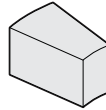

High Wedge Table

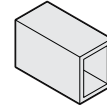

High Straight Table

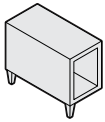

End-of-Run High Straight Table

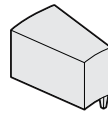

End-of-Run High Wedge Table

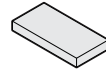

Low Straight Table

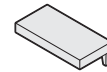

End-of-Run Low Straight Table

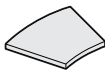

30° Ganging without Legs

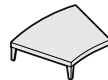

30° End-of-Run with Two Legs



30° End-of-Run with One Legs

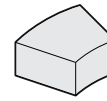

30° Ganged High Table without Legs

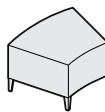

30° End-of-Run High Table with Two Legs

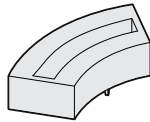

60° Ganged Table-Planter with Two Legs Front and Back

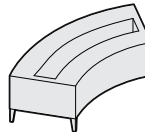

60° End-of-Run Table-Planter with Three Legs

Club Mobile

Specifying
► Page 124



Chair

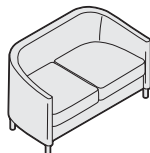

Two-seat Sofa

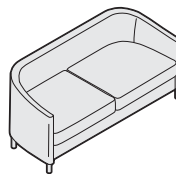

Three-seat Sofa



Chair with Tablet

Club Grande

Specifying
► Page 126

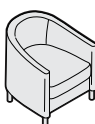

Chair

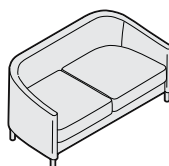

Two-seat Sofa

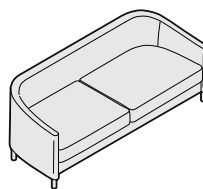

Three-seat Sofa

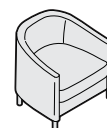

Bariatric Chair

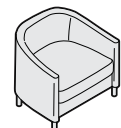

Lounge Seating, continued

Coupe

Specifying
▶ Page 128

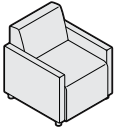

Chair

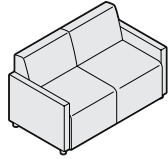

Loveseat

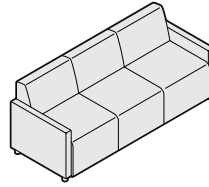

Three-seat Sofa



Ottoman

Coupe Grande/Mobile

Specifying
▶ Page 130

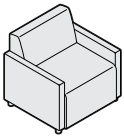

Grande Chair

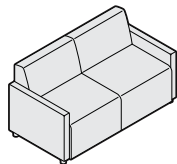

Grande Loveseat

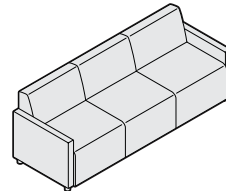

Grande Sofa

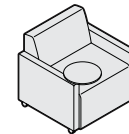

Grande Mobile Chair

Coupe with Wood

Specifying
▶ Page 132

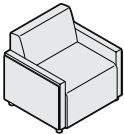

Chair with Wood

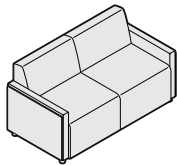

Loveseat with Wood

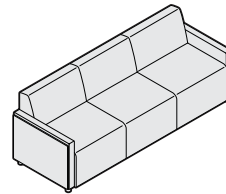

Three-seat Sofa with Wood

Davos

Specifying
▶ Page 134

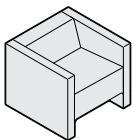

Chair

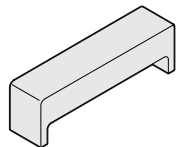

Large Bench

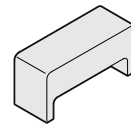

Medium Bench



Small Bench

Statement of Line

Lounge Seating, continued

Detour Lounge

Understanding
▶ Page 136
Specifying
▶ Page 140



Small Lounge/
Narrow Back
with No Arms

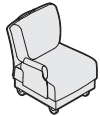

Small Lounge/
Narrow Back
with One Arm



Small Lounge/
Narrow Back
with Two Arms



Small Lounge/
Wide Back
with No Arms

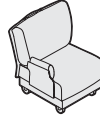

Small Lounge/
Wide Back with
One Arm



Small Lounge/
Wide Back with
Two Arms



Large Lounge
with No Arms

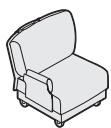

Large Lounge
with One Arm



Large Lounge
with Two Arms



Tablet
Arm

Detour Ottoman

Understanding
▶ Page 136
Specifying
▶ Page 144



Donovan

Specifying
▶ Page 148

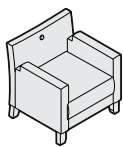

Chair

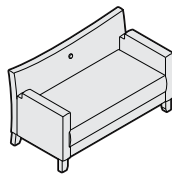

Two-seat Sofa

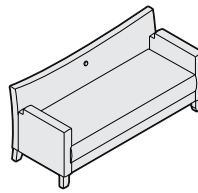

Three-seat Sofa

Lounge Seating, continued

Evaneau

Specifying
▶ Page 150

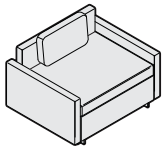

Chair

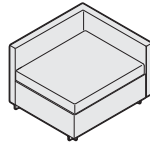

Single Arm Chair

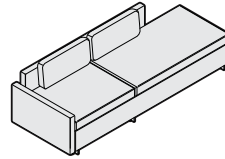

Left/Right Facing
Asymmetrical

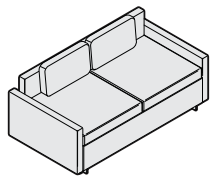

Two-seat Sofa

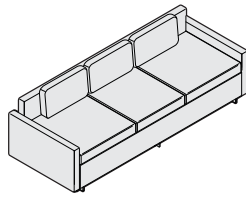

Three-seat Sofa



Low Round Ottoman

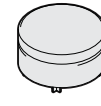

High Round Ottoman

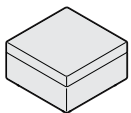

High Square Ottoman



Cushions



Arm Pillow



Arm Bolster

Herren

Specifying
▶ Page 154

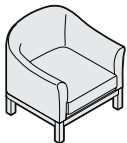

Chair

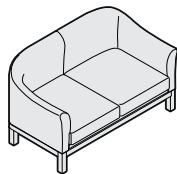

Two-seat Sofa

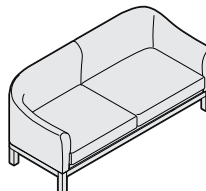

Three-seat Sofa

Holy Day Lounge Chair

Specifying
▶ Page 155



Statement of Line

Lounge Seating, continued

Hosu

Specifying
► Page 156

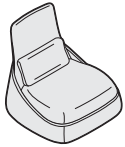

Lounge Chair

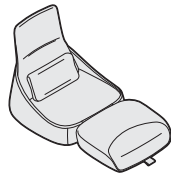

Lounge Chair
with Ottoman

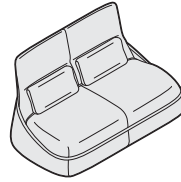

Two-seat Sofa

Joel Lounge

Specifying
► Page 159

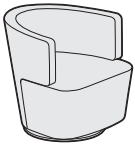

Massaud

Specifying
► Page 162



Lounge



Work Lounge



Ottoman

Millbrae Lifestyle Chairs

Specifying
► Page 166

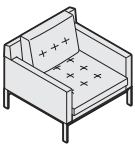

Lounge

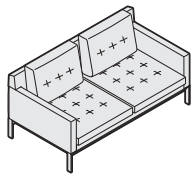

Two-seat Sofa

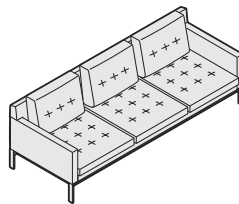

Three-seat Sofa



Round Arm Bolster



Square Arm Bolster

Lounge Seating, continued

Millbrae Contract Chairs

Specifying
▶ Page 166



Lounge
without Arms

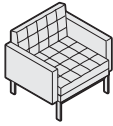

Lounge
with Arms



Lounge
with Left Arm Facing

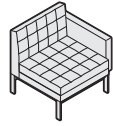

Lounge
with Right Arm Facing

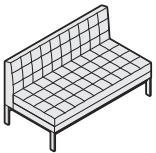

Two-seat Sofa
without Arms

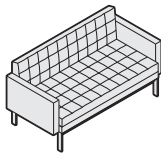

Two-seat Sofa
with Arms

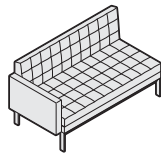

Two-seat Sofa
with Left Arm Facing

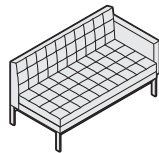

Two-seat Sofa
with Right Arm Facing

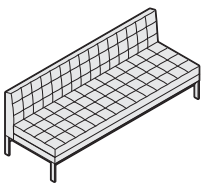

Three-seat Sofa
without Arms

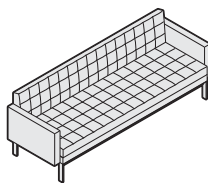

Three-seat Sofa
with Arms

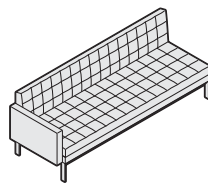

Three-seat Sofa
with Left Arm Facing

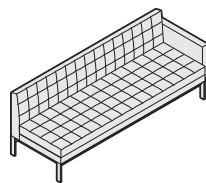

Three-seat sofa
with Right Arm Facing

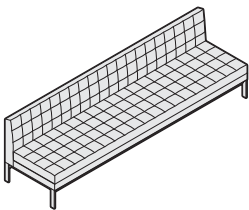

Four-seat Sofa
without Arms

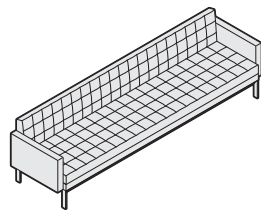

Four-seat Sofa
with Arms

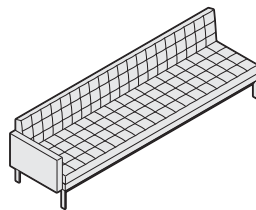

Four-seat Sofa
with Left Arm Facing

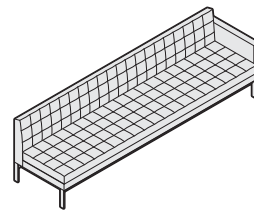

Four-seat Sofa
with Right Arm Facing

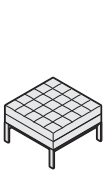

One-Seat
Bench

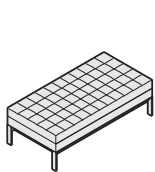

Two-Seat Bench

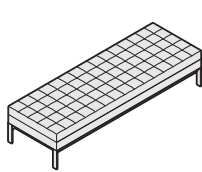

Three-Seat Bench

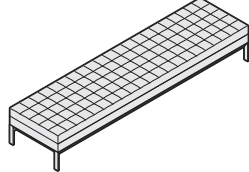

Four-Seat Bench

Statement of Line

Lounge Seating, continued

Millbrae Tables

Specifying
► Page 349

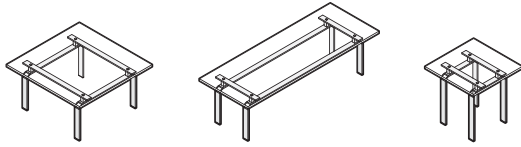

Square Tables

Rectangular Tables

Side Table

Pasio

Specifying
► Page 176

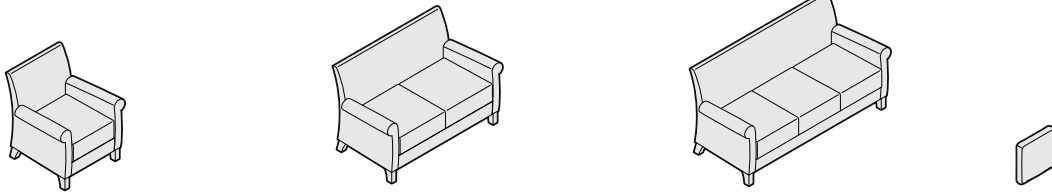

Chair

Two-seat Sofa

Three-seat Sofa

Pillow

Passerelle

Specifying
► Page 178

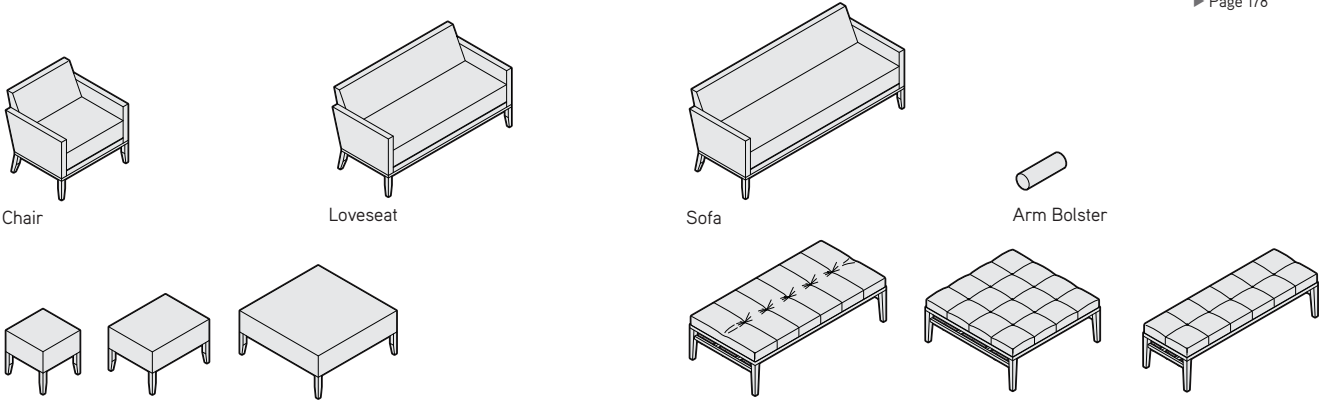

Chair

Loveseat

Sofa

Arm Bolster

Ottomans

Benches

Ripple

Specifying
► Page 182

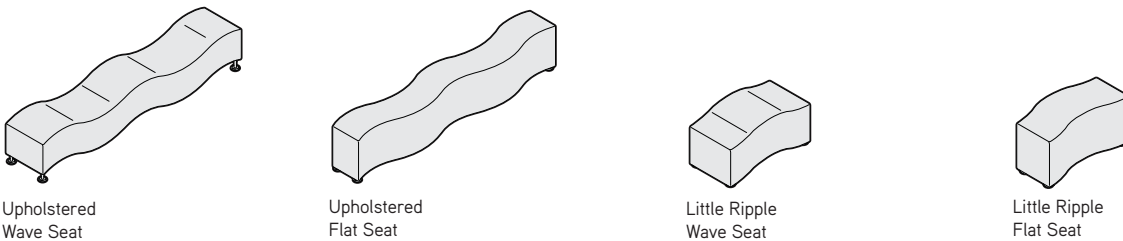

Upholstered
Wave Seat

Upholstered
Flat Seat

Little Ripple
Wave Seat

Little Ripple
Flat Seat

Lounge Seating, continued

Sidewalk Lounge/Mobile

Specifying
▶ Page 184

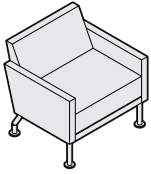

Lowback Chair

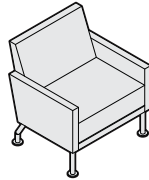

Highback Chair

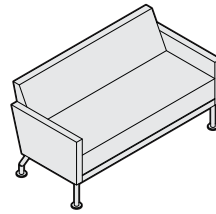

Two Seat

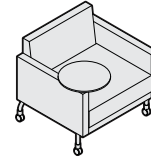

Lowback Chair
with Tablet

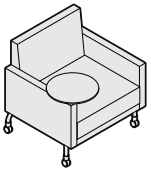

Highback Chair
with Tablet



Arm Bolster

Sidewalk Collaborative

Specifying
▶ Page 188

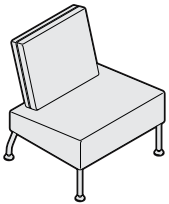

Chair

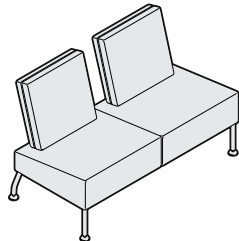

Two-seat

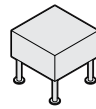

Ottoman

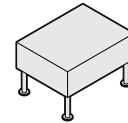
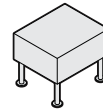

Sidewalk Ottoman/Benches

Specifying
▶ Page 190

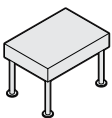

Bench

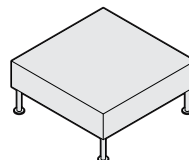
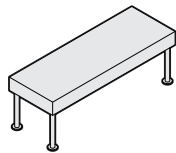
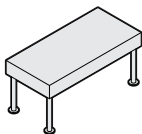

Ottoman

Statement of Line

Lounge Seating, continued

SW_1 Collaborative Lounge Chairs

Specifying
▶ Page 192



Lowback Lounge

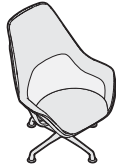

Highback Lounge



Lumbar Pillow



Ottoman



Tablet

*Left-hand tablet shown. Right-hand tablet available.

SW_1 Low Collaborative Conference Tables

Specifying
▶ Page 194



Large Round
One-Piece Top

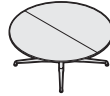

Large Round
Two-Piece Top



Square



Large Square
One-Piece Top



Large Square
Two-Piece Top



Rectangular



Super Elliptical
One-Piece Top

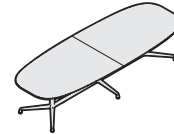

Super Elliptical
Two-Piece Top

Swathmore

Specifying
▶ Page 198

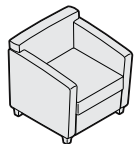

Chair with Wood Legs

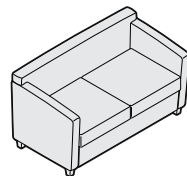

Two-seat Sofa with Wood Legs

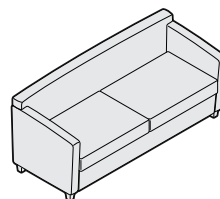

Three-seat Sofa with Wood Legs

Swathmore Louver

Specifying
▶ Page 200

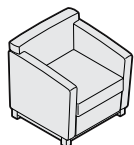

Chair with Wood
Louver Base

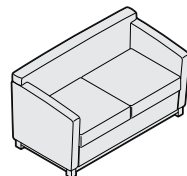

Two-seat Sofa with
Wood Louver Base

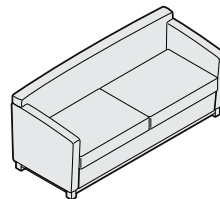

Three-seat Sofa with Wood
Louver Base

Lounge Seating, continued

Swathmore Grande with Wood Leg

Specifying
▶ Page 202

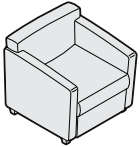

Chair with Wood Legs

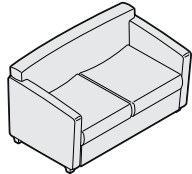

Two-seat Sofa with
Wood Legs

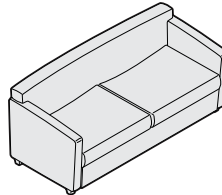

Three-seat Sofa with
Wood Legs

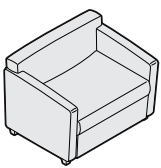

Bariatric Chair with Wood Legs

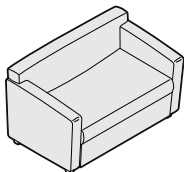

Swathmore Grande Louver

Specifying
▶ Page 204

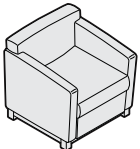

Chair with Wood
Louver Base

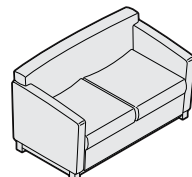

Two-seat Sofa with
Wood Louver Base

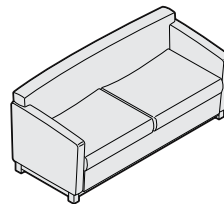

Three-seat Sofa with
Wood Louver Base

Swathmore Grande Mobile

Specifying
▶ Page 206

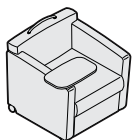

Chair/Tablet Left Facing

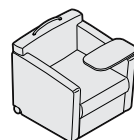

Chair/Tablet Right Facing

Statement of Line

Lounge Seating, continued

Switch

Specifying
► Page 208

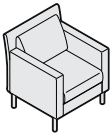

Chair

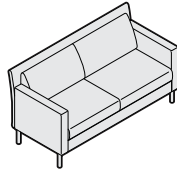

Two-seat

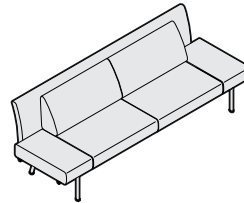

Two-seat with Extensions

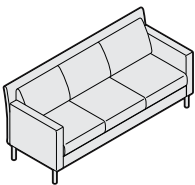

Three-seat



Arm Bolster

Thoughtful

Specifying
► Page 212

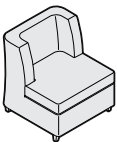

Lounge Chair

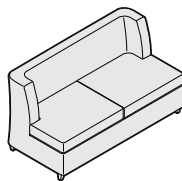

Small Sofa

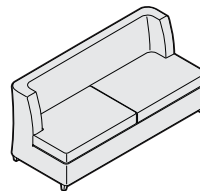

Medium Sofa

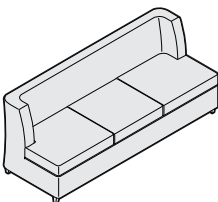

Long Sofa

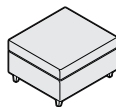

Ottoman

Lounge Seating, continued

Together Bench

Specifying
▶ Page 216

69¾"D 96½"W 31"H

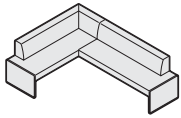

Left Corner with Back 8" Offset

96½"D 96½"W 31"H

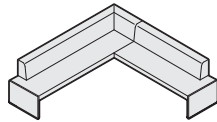

Left Corner with Back 1.5" Offset

123¼"D 69¾"W 31"H

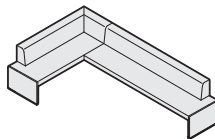

Right Corner with Back 8" Offset

96½"D 123¼"W 31"H

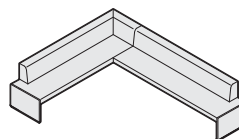

Right Corner with Back 1.5" Offset

69¾"D 96½"W 31"H

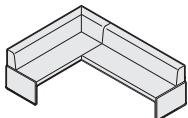

96½"D 96½"W 31"H

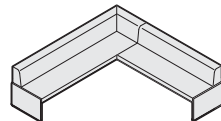

69¾"D 123¼"W 31"H

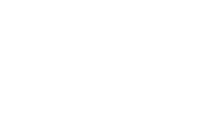

96½"D 123¼"W 31"H

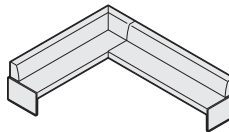

69¾"D 96½"W 31"H

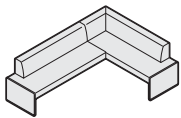

96½"D 96½"W 31"H

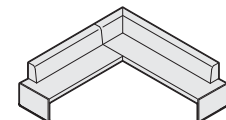

123¼"D 69¾"W 31"H

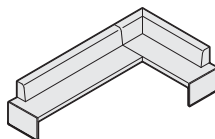

96½"D 123¼"W 31"H

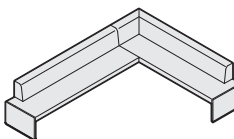

69¾"D 96½"W 31"H

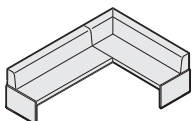

96½"D 96½"W 31"H

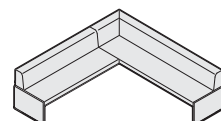

69¾"D 123¼"W 31"H

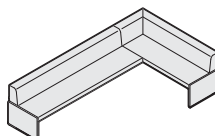

96½"D 123¼"W 31"H

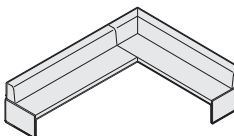

26¾"D 69¾"W 31"H

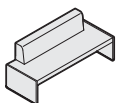

Straight with 8" Offset Back

26¾"D 96½"W 31"H

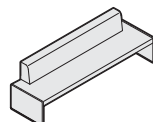

69¾"D 69¾"W 31"H

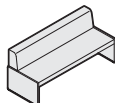

Straight with 1.5" Offset Back

26¾"D 96½"W 31"H

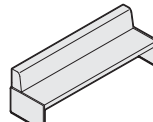

26¾"D 69¾"W 18½"H

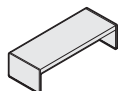

Straight without Back

26¾"D 96½"W 18½"H

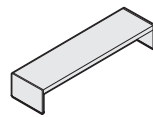

Statement of Line

Lounge Seating, continued

Topo Lounge

Understanding
▶ Page 224
Specifying
▶ Page 226



Lounge



Lounge Jr.

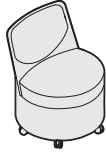

Mobile Lounge

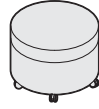

Mobile Lounge Jr.

Visalia

Specifying
▶ Page 230

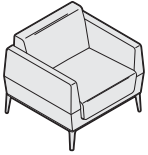

Lounge

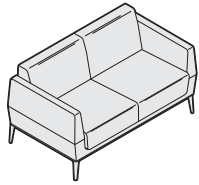

Two-Seat Chair

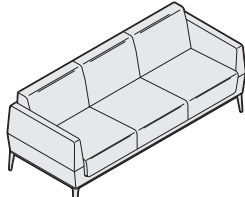

Three-Seat
Chair

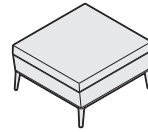

Ottoman

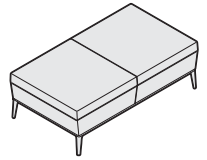

Bench

Guest/Side/Stack Seating

Andoo Chairs

Specifying
▶ Page 236



Without Arms

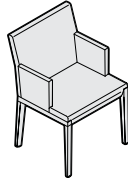

With Closed Arms

Andoo Tables

Specifying
▶ Page 237

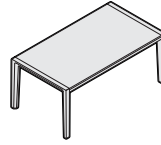

Dining Table with
Short Fixed Top

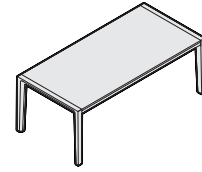

Dining Table with
Long Fixed Top

Bindu

Specifying
▶ Page 238



Low Back Guest/
Side Chair



Mid Back Guest/
Side Chair

Bob

Specifying
▶ Page 239



Guest



Ottoman

Capa

Specifying
▶ Page 240



Chair

CH24 Wishbone Chair

Specifying
▶ Page 241

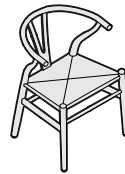

CH20 Elbow Chair

Specifying
▶ Page 242



CH53 Stool

Specifying
▶ Page 243



Statement of Line

Guest/Side/Stack Seating, continued

Enea Stacker

Specifying
► Page 244



Wood Seat and Back with Arms



Metal Stacker with Upholstered Seat and Back with Arms



Metal Stacker with Upholstered Seat and Wood Back with Arms



Metal Stacker with Polypropylene Seat and Back with Arms



Wood Seat and Back Without Arms

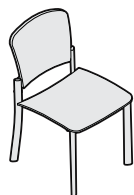

Upholstered Seat and Back Without Arms



Upholstered Seat and Wood Back Without Arms

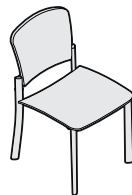

Polypropylene Seat and Back Without Arms

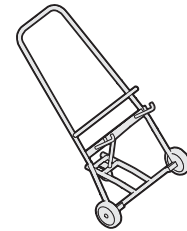

Dolly

Enea Bar-Height Stools

Specifying
► Page 248

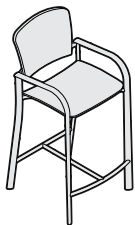

Bar-Height Stool with Wood Seat and Back with Arms

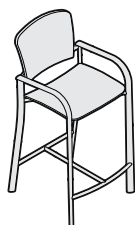

Bar-Height Stool with Upholstered Seat and Back with Arms

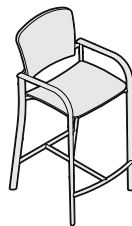

Bar-Height Stool with Upholstered Seat and Wood Back with Arms

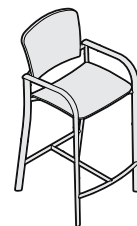

Bar-Height Stool with Polypropylene Seat and Back with Arms

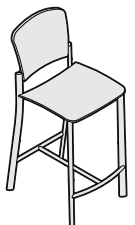

Bar-Height Stool with Wood Seat and Back Without Arms

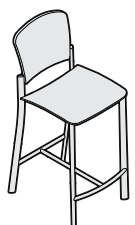

Bar-Height Stool with Upholstered Seat and Back Without Arms

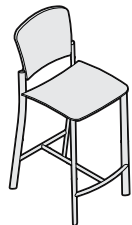

Bar-Height Stool with Upholstered Seat and Wood Back Without Arms

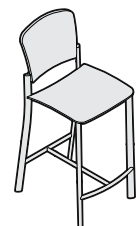

Bar-Height Stool with Polypropylene Seat and Back Without Arms

Guest/Side/Stack Seating, continued

Enea Café Stool

Specifying
▶ Page 252



Café Counter-Height Stool

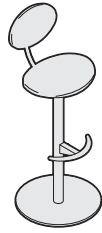

Café Bar-Height Stool



Low Stool Upholstered Seat

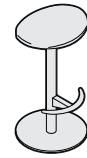

Café Counter-Height Stool Upholstered Seat

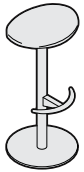

Café Bar-Height Stool Upholstered Seat

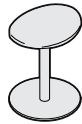

Low Stool



Café Counter-Height Stool



Café Bar-Height Stool

Enea Lottus Seating

Specifying
▶ Page 256



Armless Chair



Cantilever Arm Chair



Aluminum Loop Arm Chair



Counter Height Sled Base Stool



Bar Height Sled Base Stool

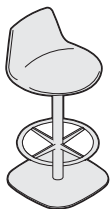

Counter Height Post Base Stool

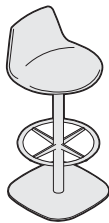

Base Height Post Base Stool

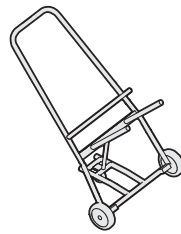

Dolly

Statement of Line

Guest/Side/Stack Seating, continued

Kart Nesting Chairs

Specifying
▶ Page 266



With Arms*

*Jury base available



Armless*

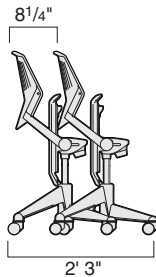

Nested

Kart Stools on Casters

Specifying
▶ Page 268



With Arms*

*Jury base available



Armless

Kart Four-Leg Stools

Specifying
▶ Page 270



Kart Stacking Chairs

Specifying
▶ Page 271



Kathryn

Specifying
▶ Page 276

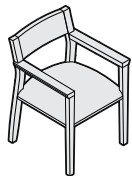

Open Wood Back

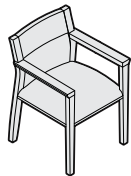

Upholstered Wood
Back Panel

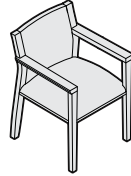

Fully Upholstered
Back

Guest/Side/Stack Seating, continued

Last Minute Stools

Specifying
▶ Page 278

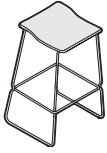

High



Medium

Lox Chairs

Specifying
▶ Page 279



Chair with
Upholstered Seat



Chair with
Upholstered
Seat and Back

Lox Stools

Specifying
▶ Page 280



Counter-Height
Stool



Bar-Height Stool

Rocky Four-Star Base Nesting Chairs

Specifying
▶ Page 281



*Jury base available

Rocky Five-Star Base Chairs*

Specifying
▶ Page 282

Rocky Five-Star Base Stools

Specifying
▶ Page 283



SW_1

Specifying
▶ Page 285



Guest Swivel Return Chair



Conference Swivel Return Chair

Statement of Line

Guest/Side/Stack Seating, continued

Switch Guest

Specifying
▶ Page 286

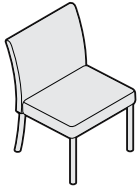

Armless Chair

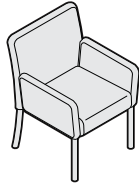

Arm Chair

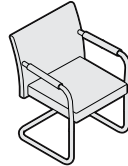

Lowback Sledbase



Highback Sledbase

Switch Stools without Arms

Specifying
▶ Page 288

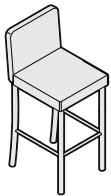

Armless Counter-Height
Stools

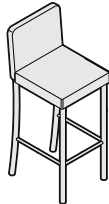

Armless Bar-Height
Stool

Wrapp Side

Specifying
▶ Page 289



Four Leg



Sled Base

X-Stack Four-Leg Stacking Chairs

Specifying
▶ Page 290



Without Arms
on Casters



With Arms
on Casters



Without Arms on
Casters with Tablet



With Arm on Casters
with Tablet

Statement of Line continued

Executive Seating

Bindu

Specifying
▶ Page 294



Mid Back Executive/
Conference Chair



High Back Executive/
Conference Chair



Low Back Guest/
Side Chair



Mid Back Guest/
Side Chair

Chord

Specifying
▶ Page 296



Conference Narrow



Midback



Highback Narrow



Highback/Large Scale

La Costa Couture

Specifying
▶ Page 298



Conference with Open
Urethane Arms



Midback with Open
Urethane Arms



Highback with
Open Urethane
Arms

La Costa/Sport

Specifying
▶ Page 300



Sled Base with
Open Urethane
Arm



Conference with
Open Urethane
Arm



Midback with
Open Urethane
Arm



High Back with
Open Urethane
Arm

Statement of Line

Executive Seating, continued

Maestro

Specifying
► Page 302



Low Back Tilt
Swivel Chair



Medium Back Tilt
Swivel Chair



High Back Tilt
Swivel Chair

Statement of Line *continued*

Occasional Tables

Avon

Specifying
▶ Page 308

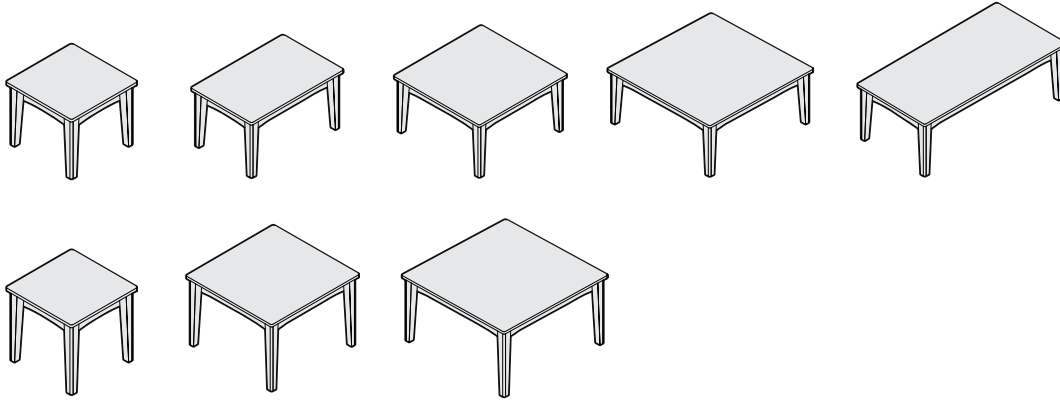

Await Tables

Specifying
▶ Pages 69 and 310

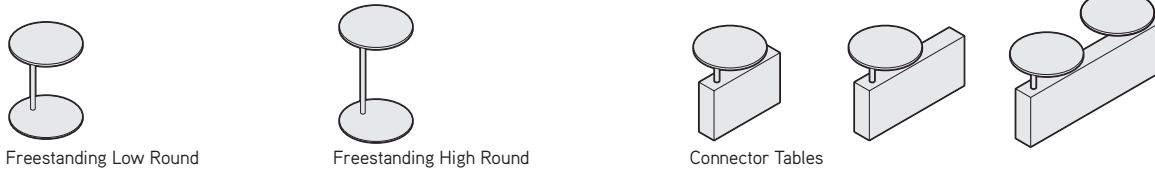

Bix 18"H Occasional Tables

Understanding
▶ Page 72
Specifying
▶ Pages 100 and 313



Statement of Line

Occasional Tables, continued

Bix Side Table

- Understanding
▶ Page 72
- Specifying
▶ Pages 102 and 312



Bob Tables

- Specifying
▶ Page 314

24" 30" 36" 42"

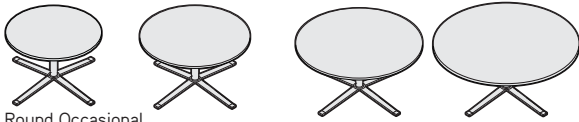

Round Occasional

24" 30" 36" 42"



Round Conference

Calm Square

- Specifying
▶ Page 316



Occasional Tables, continued

Calm Oval

Specifying
▶ Page 317



Calm Rectangle

Specifying
▶ Page 318

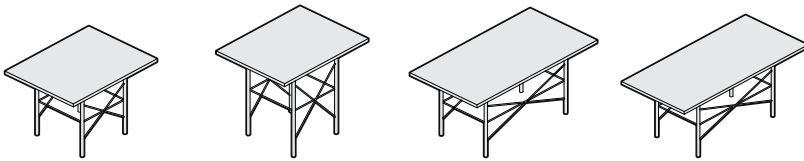

CG_1

Specifying
▶ Page 322

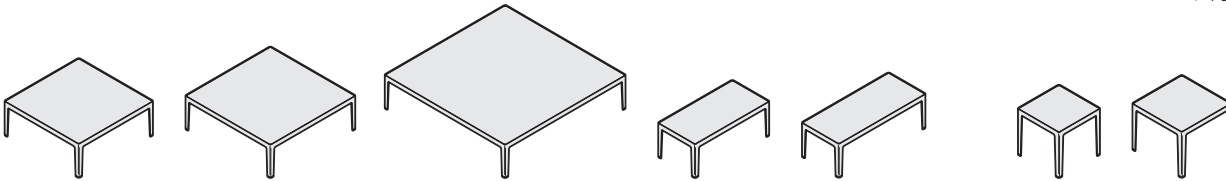

Low Square Tables

Low Rectangular Tables

High Square Tables

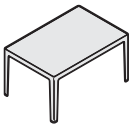

High Rectangular Table

CH008 Sofa Tables

Specifying
▶ Page 324

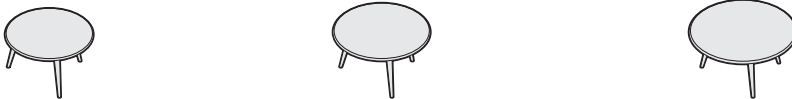

30" Round Sofa Table

34½" Round Sofa Table

39¼" Round Sofa Table

CH100 Occasional Table

Specifying
▶ Page 325

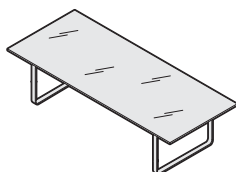

Glass Coffee Table

CH327 Dining Tables

Specifying
▶ Page 326

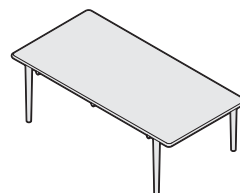

Statement of Line

Occasional Tables, continued

Circa Freestanding Tables

Specifying
► Pages 118 and 327

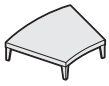

30° Freestanding Low Table with Four Legs

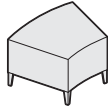

30° Freestanding High Table with Four Legs

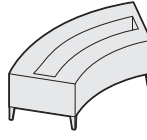

60° Freestanding Planter Table with Five Legs

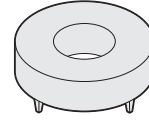

Round

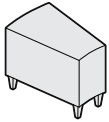

High Wedge

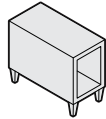

High Straight

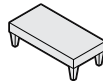

Low Straight

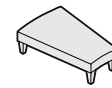

Low Wedge

Denizen Tablet Table

Specifying
► Pages 329



Denizen Console Table

Specifying
► Pages 330

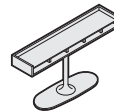

Diekman

Specifying
► Pages 331

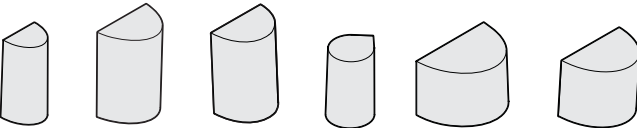

Wood

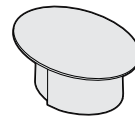

Wood Base with Elliptical Top

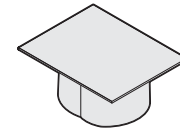

Wood Base with Rectangle Top

Donovan

Specifying
► Pages 332

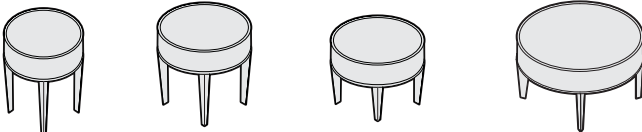

Round

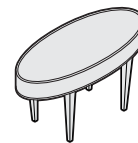

Elliptical

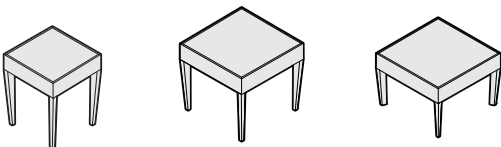

Square

Occasional Tables, continued

Enea Single Base

Specifying
► Page 334

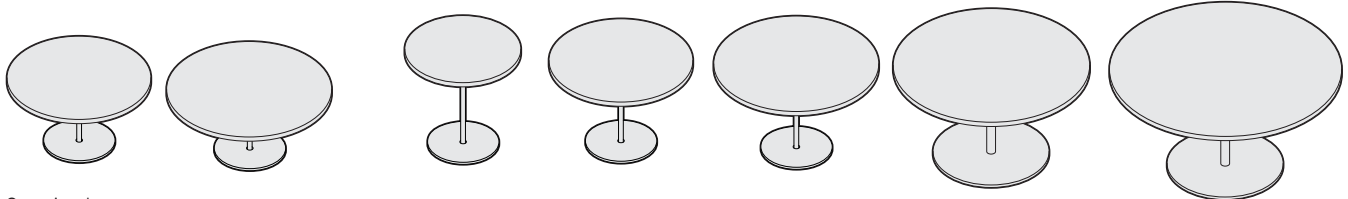

Occasional

Conference

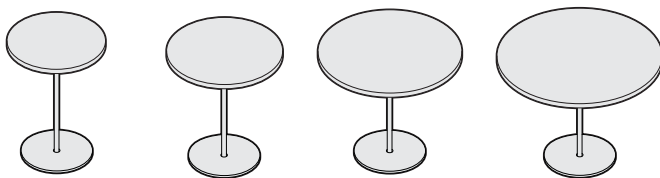

Café/Counter Height

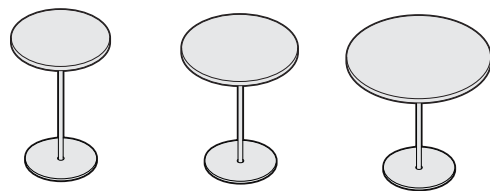

Café/Bar Height

Enea Twin Bases

Specifying
► Pages 336

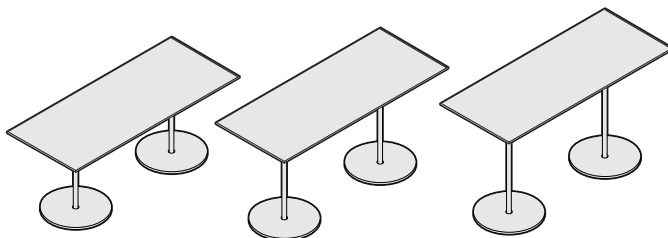

Rectangular

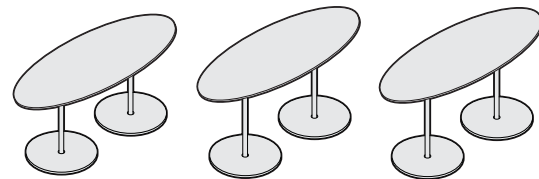

Oval

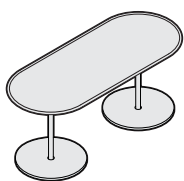

Conference
Racetrack

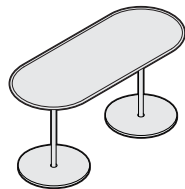

Counter Racetrack

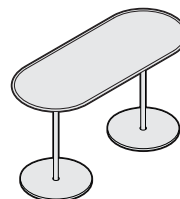

Café Racetrack

Occasional Tables, continued

Enea Lottus Tables

Specifying
► Page 338

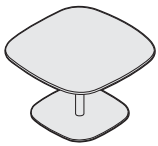

Occasional



Conference



Café Counter Height

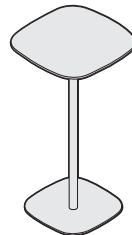

Café Bar Height

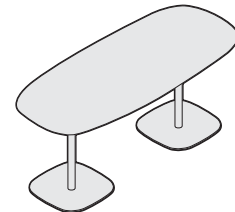

Rectangular

Free Stand

Specifying
► Pages 344



Ginger

Specifying
► Pages 346

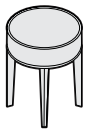

Round

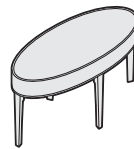
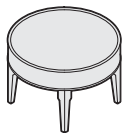

Elliptical

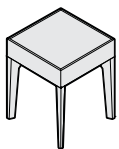

Square

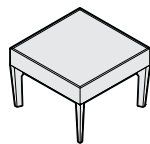
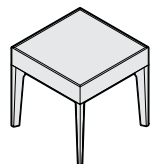

Holy Day Tables

Specifying
► Page 348



Round Table

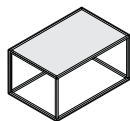

Rectangular Table

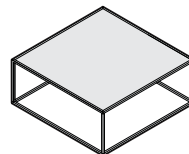

Square Table

Occasional Tables, continued

Millbrae Tables

Specifying
► Page 349

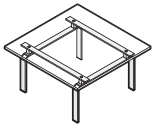

Square Tables

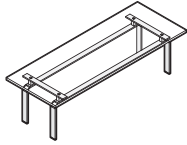

Rectangular Tables

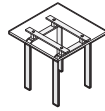

Side Table

Passerelle

Specifying
► Page 350

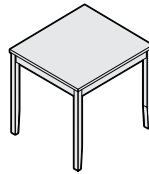
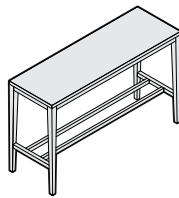
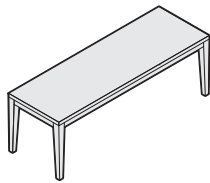
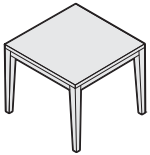

Sebastopol

Specifying
► Page 352

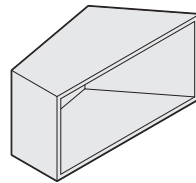
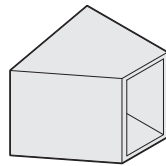
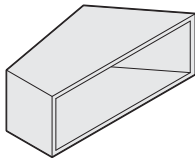
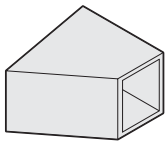

16" High Tables

22" High Tables

Sidewalk Occasional Tables

Specifying
► Page 354

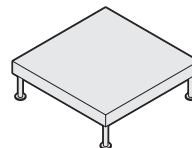
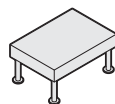
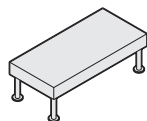
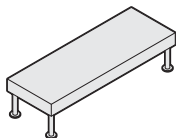
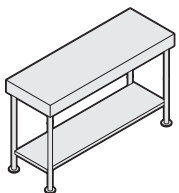
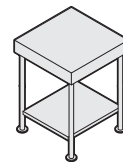
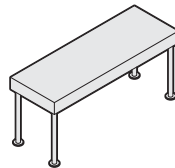
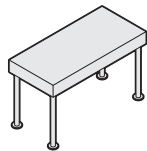
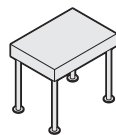
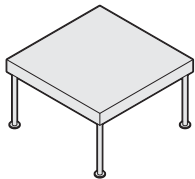
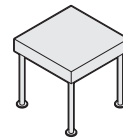
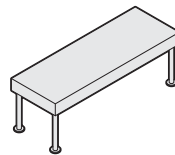
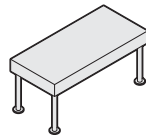
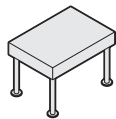
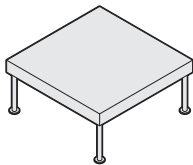
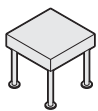

Occasional Tables, continued

Sidewalk Storage

Specifying
► Page 357

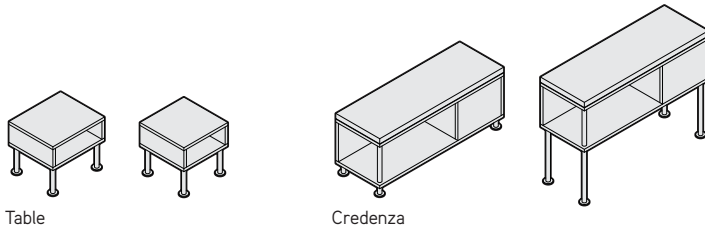

Soft Leaf

Specifying
► Page 358

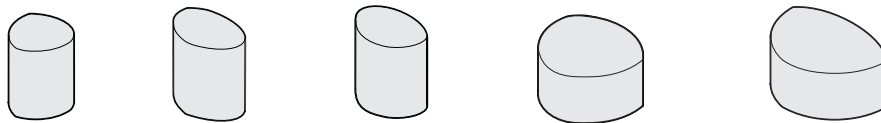

SW_1 Occasional Tables

Specifying
► Page 360

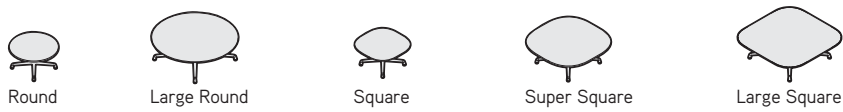

Swathmore Plus

Specifying
► Page 362

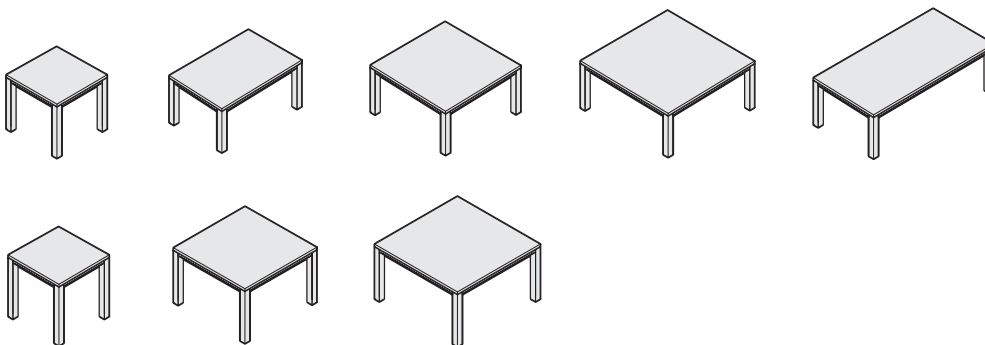

Occasional Tables, continued

Switch

Specifying
▶ Page 364

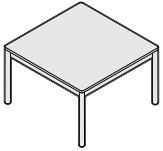

Square

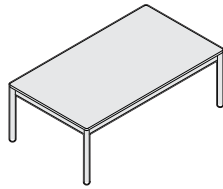

Rectangle

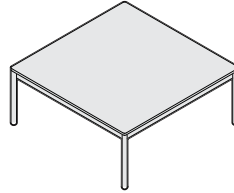

Square Table

TeamWork Satellite Table

Specifying
▶ Page 366



Trees

Specifying
▶ Page 368

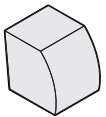

Curve Low, Lacquer
Paint-High Gloss

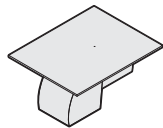

Curve Low, Lacquer
Paint (2 Bases)-
Glass Top

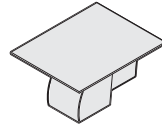

Curve Low/Cube,
Low Wood, Lacquer-
Glass Top

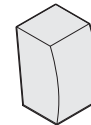

Curve High-
Stainless Steel

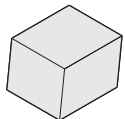

Cube Low SensiTile

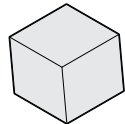

Cube Low
Embossed
Wood/Black Only

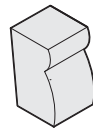

Fold High-
Stainless Steel

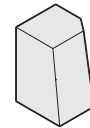

Bevel High-
Embossed Wood

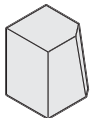

Bevel Medium-
Embossed Wood

Statement of Line

Indoor/Outdoor Seating

Emu Heaven

Specifying
▶ Page 374



Chair



Arm Chair

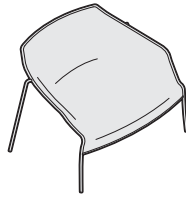

Lounge Chair



Pouf/Side Table



Low Vase

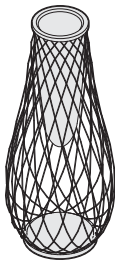

High Vase



Cushions



Round Table Bases

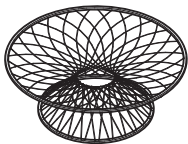
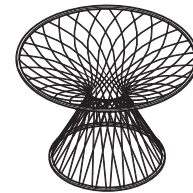

Low Table Base



Glass Tops

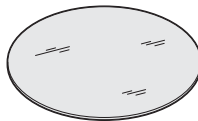

Tip: Cushions are available for indoor and outdoor use.

Indoor/Outdoor Seating, continued

Emu Ivy

Specifying
▶ Page 380



Side Chair



Side Arm Chair

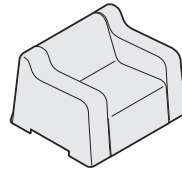

Arm Chair

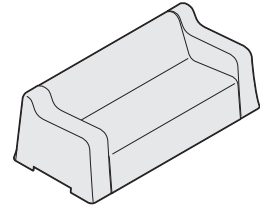

Sofa



Pouf

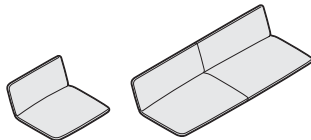

Cushions

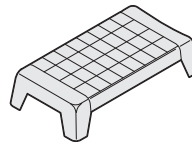

Rectangular Side Table

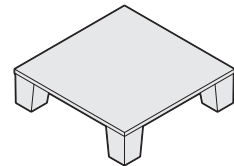

Square Side Table

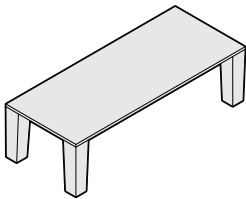

Rectangular Metal Top Table

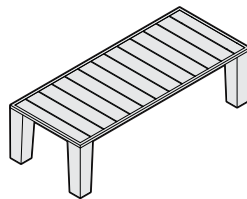

Rectangular Teak Top Table

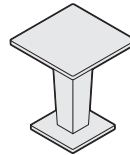

Square Table

Tip: Cushions are available for indoor and outdoor use.

Emu Pattern

Specifying
▶ Page 383



Arm Chair



Armless Chair

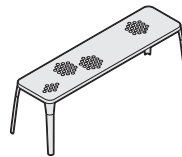

Rectangular Bench



Small Round Table

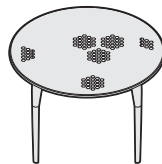

Large Round Table

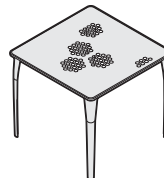

Square Table

Statement of Line

Indoor/Outdoor Seating, continued

Emu Re-Trouvé

Specifying
▶ Page 386



Midback Chair

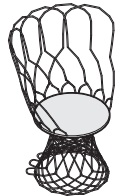

Highback Chair



Pouf



Low Vase Frame



High Vase Frame

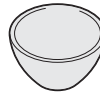

Vase Insert



Cushions



Tip: Cushions are available for indoor and outdoor use.

Emu Round

Specifying
▶ Page 388



Stool



Chair



Arm Chair



Lounge

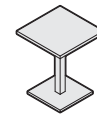

Square Tables

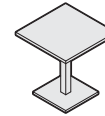

Round Table

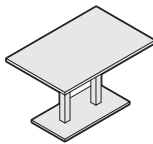

Rectangle Table

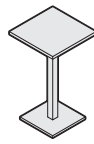

Counter Table

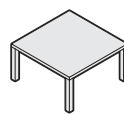

Side Tables

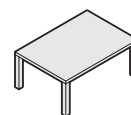

Emu Shade

Specifying
▶ Page 391

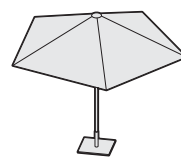
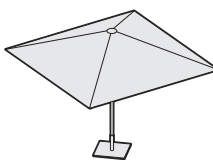
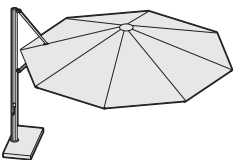

Lounge Seating

Archipelago	54
Astor	64
Await	66
Bix	72
Bob Chairs	103
CH07 Shell Chair	104
CH25 Paddle Chair	105
CH44 Ladderback Chair	106
CH100 Series	107
CH401 Airport Chair	108
CH445 Wing Chair	109
Circa	110
Club	124
Coupe	128
Davos	134
Detour	136
Donovan	148
Evaneau	150
Herren	154
Holy Day Lounge Chair	155
Hosu	156
Joel Lounge	159
Massaud	162
Millbrae	166
Pasio	176
Passerelle	178
Ripple	182
Sidewalk	184
SW_1	192
Swathmore	198
Swathmore Grande	202
Switch	208
Thoughtful	212
Together	216
Topo Lounge	224
Visalia	230

Archipelago

DESIGN METRO DESIGN GROUP WITH EIGHT INC.

Archipelago lounge seating features a simple, versatile design that works well in an informal work setting. Lounge chairs may be specified individually or connected with elliptical, fully upholstered arms or pivoting tablet arms. An ottoman is also available.

Back is fully upholstered. The position of the back cushion varies depending on the chair model.

Tablet arm pivots on a 60° angle. It has a wood core with a laminate or wood veneer surface.

Soft casters are non-locking. *Tip: casters are not recommended for connected lounge sections.*

Legs are constructed with steel and finished with any paint color.

Adjustable glides are standard on models with legs. Bottom of glide is black plastic, with no adjustment.

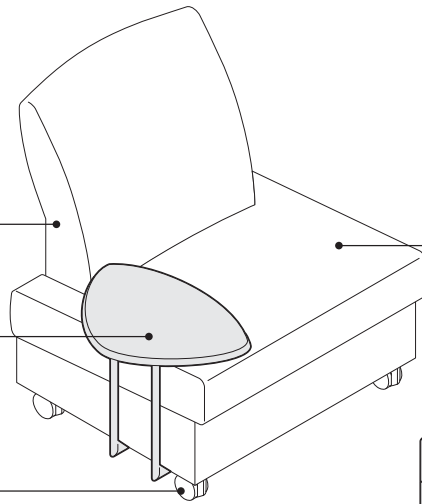

Seat is fully upholstered.

Ottoman can be used as a mobile footrest, bench, or soft worksurface.

Casters are standard on ottoman.

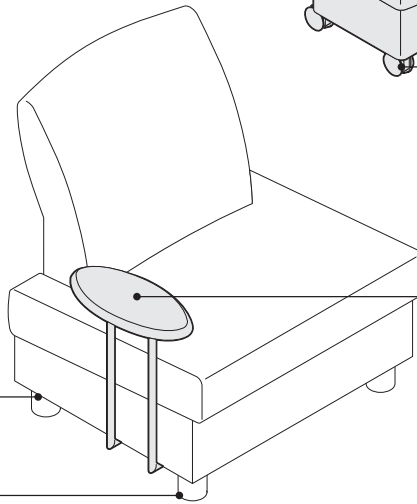

Elliptical arms are available in wood. They can be positioned to the left or right side or intermediate between two seats. Fully upholstered arm is also available.

Actual Dimensions

	Overall			Seat		Seat height from floor: at front, at back	Back height from seat at back	Back width	Arm/tablet height
	Depth	Width	Height	Depth	Width				
Lounge	29"	32"	35"	20"	32"	17" - front 15" - back	20"	24"	23½"
Lounge, left or right section	29"	28"	35"	20"	28"	17" - front 15" - back	20"	24"	23½"
Lounge, straight section	29"	24"	35"	20"	24"	17" - front 15" - back	20"	24"	23½"
Elliptical arm	16"	8"	23½" when attached	N.A.	N.A.	N.A.	N.A.	N.A.	N.A.
Upholstered arm	14"	6"	23½" when attached	N.A.	N.A.	N.A.	N.A.	N.A.	N.A.
Tablet arm	19¾"	13¾"	23½" when attached	N.A.	N.A.	N.A.	N.A.	N.A.	N.A.
Ottoman	17½"	23¾"	16½"	N.A.	N.A.	N.A.	N.A.	N.A.	N.A.

Archipelago

DESIGN METRO DESIGN GROUP WITH EIGHT INC.

Product Details

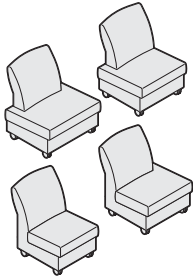

Lounge chair is available in four models – 32" W straight, left section, right section, and 24" W straight.



32" W straight lounge chair has a back cushion that is centered on the back of the chair. It has a 4" extension on each side of the back cushion. It can stand-alone or be adjoined to another lounge chair. An arm or tablet arm may be attached to either side.



Left-section lounge chair has a back cushion that is flush on the right side and has a 4" extension on the left side when facing the front of the chair.

Tip: The right side will adjoin with a straight or right-section lounge chair. An arm or tablet arm may be attached to the extended left side.



Right-section lounge chair has a back cushion that is flush on the left side and has a 4" extension on the right side when facing the front of the chair.

Tip: The left side will adjoin with a straight or left-section lounge chair. An arm or tablet arm may be attached to the extended right side.



24" W straight-section lounge chair has a back cushion that is flush on both sides of the chair. It can stand-alone or adjoin to another chair with a straight side.

Tip: An arm or tablet arm cannot be attached to the straight-section lounge chair.



Ottoman is equipped with casters. It is intended as a footrest. However, it also provides a backless seating option.

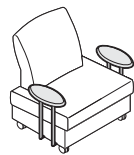
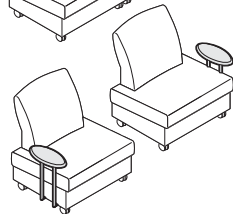
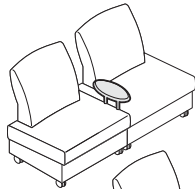

Elliptical arm is available in two styles – intermediate or end. The intermediate arm attaches between adjoining chairs. The end arm is handed for use on the left- or right-hand side. It is available with a laminate or wood veneer surface.

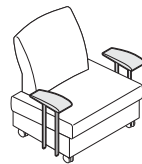
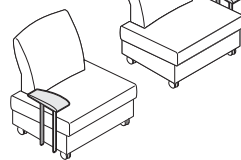
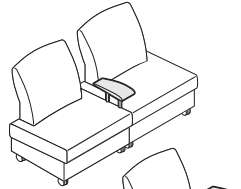

Fully upholstered arm is available in two styles – intermediate or end. An intermediate arm attaches between adjoining chairs. The end arm is handed for use on the left- or right-hand side.

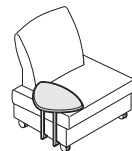

Tablet arm pivots on a 60° angle. It is handed for use on the left- or right-hand side. It is field installed.

Multiple fabrics can be specified on an individual unit for an additional fee per specified fabric. A lounge chair can have up to two additional fabrics. An ottoman can have one additional fabric.

Lounge chair

- Seat cushion and sides of seat cushion - no additional fee
- Back cushion (including the front, back, and sides of back cushion) - additional fee
- Base frame - additional fee
- Fully upholstered arms (if selected and ordered separately) - no additional fee

Ottoman

- Seat cushion and sides of seat cushion - no additional fee
 - Base frame - additional fee
- ▶ See *Archipelago Multi-Fabric Diagram and Yardage Request Form*, page 61.

Tip: Fully upholstered arms, if selected, can have a contrasting fabric. However, since they are ordered separate from the chair, simply order the arms with whatever kind of fabric is desired.

Connections

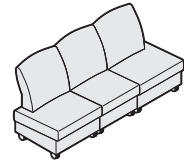

Straight side of a chair adjoins to another straight side. Ganging brackets are provided.

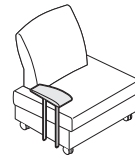

End arm connects to the extended side of a chair. An end arm cannot attach to the straight side of a chair.

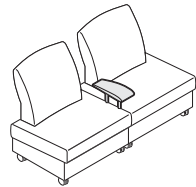

Intermediate arms connect between two adjoining chairs that have extended sides.

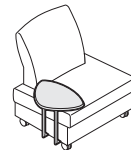

Tablet arm connects to the extended side of a chair. A tablet arm cannot attach to the straight side of a chair.

Casters are not recommended for connected lounge sections.

Archipelago *continued*

DESIGN METRO DESIGN GROUP WITH EIGHT INC.

Surface Materials

Seat, back, and base frame

- Fabric

Elliptical arm

- Laminate
- Wood

Fully upholstered arm

- Fabric

Tablet surface

- Laminate Grade 1
- Wood veneer

Support for arm or tablet

- Paint

Leg and glides

- Paint

Casters

- Black plastic only

Note: Refer to the Coalesse Surface Materials Reference Guide for additional surface materials information.

Programs & Services

Fire code seating (FCS) modifications are available to meet CAL TB133 requirements.

▶ See *Coalesse Surface Materials Reference Guide*.

Customer's Own Material/Leather (COM/COL) Program is available.

▶ See *Coalesse Surface Materials Reference Guide* for additional information.

Designers

Metro Design Group with Eight Inc.

Coalesse

Archipelago

DESIGN METRO DESIGN GROUP WITH EIGHT INC.

Archipelago Lounge Chairs and Ottoman

DESIGN METRO DESIGN GROUP WITH EIGHT INC.

Tip: For Customer's Own Material or Leather, see necessary requirements, important processing instructions, and ordering information on page ▶ See Coalesse Surface Materials Reference Guide.

Tip: Arms and tablet arms, if selected, should be entered on consecutive lines of the purchase order immediately following the lounge chair to which they will be applied. Components for identical chair configurations may be grouped together on consecutive lines.

Tip: Begin a new series of line items for each chair configuration.

Tip: For veneer tops, edge and top will be the same finish color. For laminate tops, edge will always be black.

Tip: When specifying fabric in different price grades, the highest price grade prevails.

Tip: Arms are ordered separately. They can be specified with matching or contrasting upholstery.

Tip: The COM yards and COL square footage listed on these pages reflect the requirements for a single fabric that are based on non-directional 54"W material applied railroaded. For multi-fabric COM requirements, please refer to Multi-Fabric Diagram and Yardage Request Form.

▶ Page 61

Tip: Fully upholstered arms do not require additional COM yardage or COL square footage.

Tip: Handedness is determined while facing the chair.

Tip: Fabrics and leathers will appear loose with comfort wrinkles when upholstered.



For Canadian Pricing
Multiply U.S. Price by the Canadian price factor.
▶ See page 1 for details.

Standard Includes	Required to Specify
<ul style="list-style-type: none"> ▶ Need help? Product details, page 54 • Lounge chair: <ul style="list-style-type: none"> - Seat, back, and base frame: fabric or leather - Legs and glides, if selected: paint - Casters, if selected: black plastic only • Arm, if selected: <ul style="list-style-type: none"> - Elliptical arm: laminate (Grade 1) or wood veneer - Fully upholstered arm: fabric or leather - Support: paint • Tablet arm, if selected: <ul style="list-style-type: none"> - Surface: laminate (Grade 1) or wood veneer - Support: paint • Ottoman: <ul style="list-style-type: none"> - Seat: fabric or leather - Casters: black plastic only 	<ol style="list-style-type: none"> 1 Style number 2 Number of fabrics if contrasting fabric style number is selected 3 Fabric or leather color number for seat, back, and fully upholstered arm or ottoman, if selected 4 Paint color number for legs and glides, base frame and support, if selected 5 Laminate or wood color number for elliptical arm or tablet arm, if selected <p>▶ See <i>Coalesse Surface Materials Reference Guide</i>.</p> <ol style="list-style-type: none"> 6 Options, if selected (see below) <p>▶ See <i>Coalesse Surface Materials Reference Guide</i>.</p>

Options	U.S. Price	Required to Specify
Surface Materials <ul style="list-style-type: none"> • Contrasting fabric 	+\$113 per fabric	Add suffix K to the style number and select fabric color number.
Fire code seating <ul style="list-style-type: none"> • CAL 133 for lounge and ottoman • CAL 133 for upholstered arms 	+\$218 +\$113	Specify with CAL 133. Specify with CAL 133. ▶ See <i>Coalesse Surface Materials Reference Guide</i> .
Acrylic backer <ul style="list-style-type: none"> • Backer for 24"W chair • Backer for 28"W and 32"W chairs • Backer for ottoman • Backer for upholstered arms 	+\$ 35 +\$ 39 +\$ 21 +\$ 4	Specify with acrylic backer. Specify with acrylic backer. Specify with acrylic backer. Specify with acrylic backer. ▶ See <i>Coalesse Surface Materials Reference Guide</i> .

Specification Information													
Style Number	U.S. Base Prices												
	Fabric Grades:												
	COM	6	7	8	9	10	11	12	13	14	Leather Grades:		
											COL	C	E
32"W Straight Lounge Chair													
With Casters													
910C	\$2013	\$2160	\$2221	\$2269	\$2388	\$2453	\$2507	\$2628	\$2683	\$2943	\$2284	\$3607	\$3858
With Glides													
910G	\$2013	\$2160	\$2221	\$2269	\$2388	\$2453	\$2507	\$2628	\$2683	\$2943	\$2284	\$3607	\$3858
COM/yds = 4¼, COL/sq ft = 77													

▶ Specification Information, continued on next page

Archipelago Lounge Chairs and Ottoman

DESIGN METRO DESIGN GROUP WITH EIGHT INC.

Tip: Handedness is determined while facing the chair.

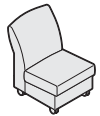
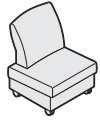

► Specification Information, continued from previous page

Specification Information

Style Number	U.S. Base Prices										Leather Grades:		
	Fabric Grades:										COL	C	E
	COM	6	7	8	9	10	11	12	13	14			

28"W Left-Section Lounge Chair

With Casters

910LC	\$1970	\$2117	\$2178	\$2226	\$2345	\$2410	\$2464	\$2585	\$2640	\$2900	\$2238	\$3712	\$3988
-------	--------	--------	--------	--------	--------	--------	--------	--------	--------	--------	--------	--------	--------

With Glides

910LG	\$1970	\$2117	\$2178	\$2226	\$2345	\$2410	\$2464	\$2585	\$2640	\$2900	\$2238	\$3712	\$3988
-------	--------	--------	--------	--------	--------	--------	--------	--------	--------	--------	--------	--------	--------

COM/yds = 4¼, COL/sq ft = 85

28"W Right-Section Lounge Chair

With Casters

910RC	\$1970	\$2117	\$2178	\$2226	\$2345	\$2410	\$2464	\$2585	\$2640	\$2900	\$2238	\$3712	\$3988
-------	--------	--------	--------	--------	--------	--------	--------	--------	--------	--------	--------	--------	--------

With Glides

910RG	\$1970	\$2117	\$2178	\$2226	\$2345	\$2410	\$2464	\$2585	\$2640	\$2900	\$2238	\$3712	\$3988
-------	--------	--------	--------	--------	--------	--------	--------	--------	--------	--------	--------	--------	--------

COM/yds = 4¼, COL/sq ft = 85

24"W Straight-Section Lounge Chair

With Casters

910XC	\$1846	\$1960	\$2010	\$2050	\$2149	\$2203	\$2246	\$2345	\$2390	\$2604	\$2066	\$3313	\$3539
-------	--------	--------	--------	--------	--------	--------	--------	--------	--------	--------	--------	--------	--------

With Glides

910XG	\$1846	\$1960	\$2010	\$2050	\$2149	\$2203	\$2246	\$2345	\$2390	\$2604	\$2066	\$3313	\$3539
-------	--------	--------	--------	--------	--------	--------	--------	--------	--------	--------	--------	--------	--------

COM/yds = 3½, COL/sq ft = 70

Specification Information

Dimensions			Style Number	U.S. Base Prices			
D	W	H		Lam 1	Lam 2	Wood 1	Upholstered

Elliptical Intermediate Arm

16"	8"	23½"	910IA	\$368	\$384	\$404	N.A.
-----	----	------	-------	-------	-------	-------	------

Left-Handed Elliptical End Arm

16"	8"	23½"	910EAL	\$368	\$384	\$404	N.A.
-----	----	------	--------	-------	-------	-------	------

Right-Handed Elliptical End Arm

16"	8"	23½"	910EAR	\$368	\$384	\$404	N.A.
-----	----	------	--------	-------	-------	-------	------

► Specification Information, continued on next page

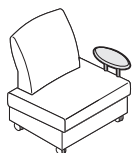
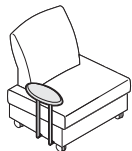
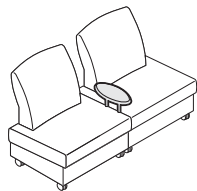

Archipelago Lounge Chairs and Ottoman *continued*

DESIGN METRO DESIGN GROUP WITH EIGHT INC.

Tip: Handedness is determined while facing the chair.

Tip: Fabrics and leathers will appear loose with comfort wrinkles when upholstered.

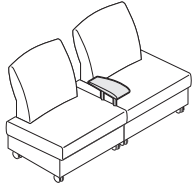

Tip: Fully upholstered arms do not require additional COM yardage or COL square footage.

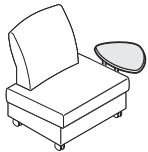
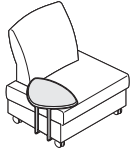
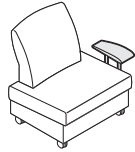
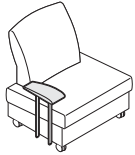

17½"D 23¾"W 16½"H

► Specification Information, continued from previous page

Specification Information

Dimensions D W H	Style Number	U.S. Base Prices			
		Lam 1	Lam 2	Wood 1	Upholstered

Fully Upholstered Intermediate Arm

14"	6"	23½"	910UIA	N.A.	N.A.	N.A.	\$601
-----	----	------	--------	------	------	------	-------

Left-Handed Fully Upholstered End Arm

14"	6"	23½"	910UEAL	N.A.	N.A.	N.A.	\$601
-----	----	------	---------	------	------	------	-------

Right-Hand Fully Upholstered End Arm

14"	6"	23½"	910UEAR	N.A.	N.A.	N.A.	\$601
-----	----	------	---------	------	------	------	-------

Left-Hand Tablet Arm

19¾"	13¾"	23½"	910TAL	\$684	\$717	\$786	N.A.
------	------	------	--------	-------	-------	-------	------

Right-Hand Tablet Arm

19¾"	13¾"	23½"	910TAR	\$684	\$717	\$786	N.A.
------	------	------	--------	-------	-------	-------	------

Specification Information

Style Number	U.S. Base Prices													
	Fabric Grades:													
	COM	6	7	8	9	10	11	12	13	14	Leather Grades:			
											COL	C	E	

Ottoman

911	\$790	\$839	\$867	\$891	\$947	\$976	\$1003	\$1059	\$1085	\$1208	\$916	\$1778	\$1920
-----	-------	-------	-------	-------	-------	-------	--------	--------	--------	--------	-------	--------	--------

COM/yds = 2.5, COL/sq ft = 55



For Canadian Pricing
 Multiply U.S. Price by the Canadian price factor.
 ► See page 1 for details.

Archipelago Multi-Fabric Diagram and Yardage Request Form

DESIGN METRO DESIGN GROUP WITH EIGHT INC.

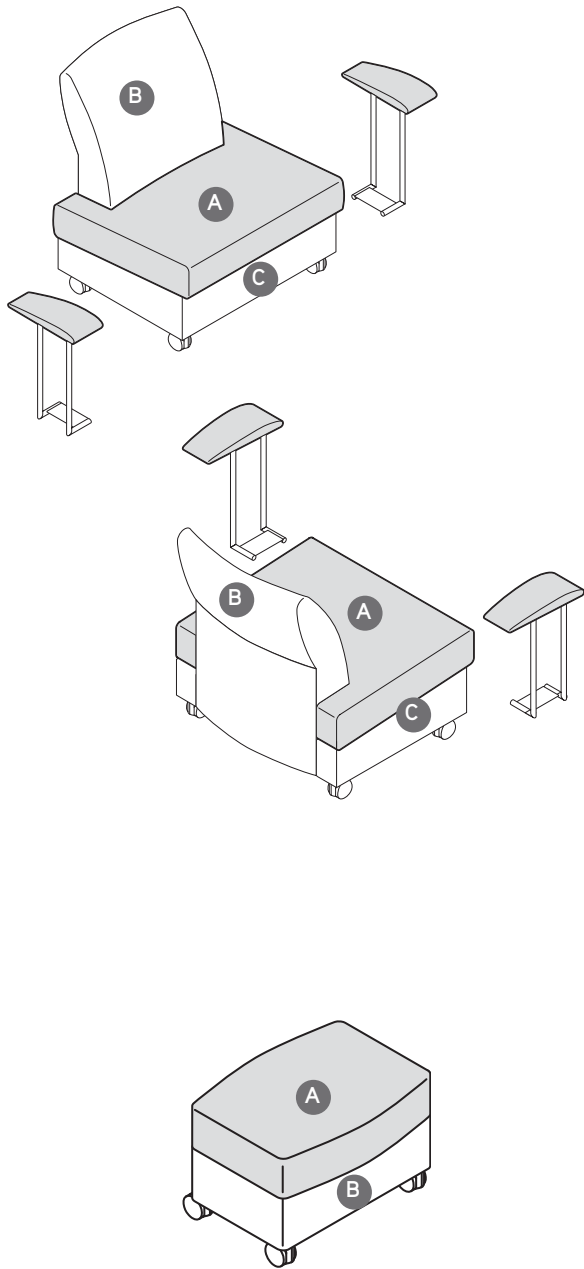

Lounge

TO: _____

FROM: _____

DATE: _____

FAX....888.413.5161

A Seat (upholstery selections default for entire unit if B is not selected): _____

B Back: _____

C Baseframe: _____

**Arms ordered as separate option.*

**\$113 U.S. list per contrasting fabric specified. List price based on highest fabric grade usage.*

Lounge Seating

Ottoman

TO: _____

FROM: _____

DATE: _____

FAX....888.413.5161

A Seat (upholstery selections default for entire unit if B is not selected): _____

B Baseframe: _____



For Canadian Pricing
 Multiply U.S. Price by the
 Canadian price factor.
 ► See page 1 for details.

Archipelago Multi-Fabric Yardage

DESIGN METRO DESIGN GROUP WITH EIGHT INC.

Multi-Fabric Yardage

CHAIR MODEL	STYLE NUMBER	COM YDS*		
		SEAT CUSHION	BACK CUSHION	BASE FRAME
Lounge with casters	910C	3	2	2 1/2
Lounge with glides	910G	3	2	2 1/2
Lounge with casters, left section	910LC	3	2	2 1/2
Lounge with glides, left section	910LG	3	2	2 1/2
Lounge with casters, right section	910RC	3	2	2 1/2
Lounge with glides, right section	910RG	3	2	2 1/2
Lounge with casters, straight section	910XC	3	2	2 1/2
Lounge with glides, straight section	910XG	3	2	2 1/2
Ottoman	911	1 1/4	N.A.	1 1/4

*Fabric yardage is based on non-directional/solid fabrics. Use conversion chart below for repeat/printed fabric yardage.

Non-standard fabric requirements

Yardage requirements shown are based on non-directional 54" w material applied railroaded. Coalesse will apply fabric railroaded unless instructed otherwise on the dealer's purchase order. The following conversion chart should be used to determine yardage requirements when COM has a repeat of 2" or more. Please contact Coalesse customer service for a yardage quotation if the fabric is less than 54" wide, has a repeat of more than 24", or if the fabric must be cut-right.

CONVERSION CHART

PRODUCT	REPEAT		
	2" - 8"	9" - 14"	15" - 24"
All other products	15%	25%	35%

Yardage quotations will also be provided for order of 10 or more pieces.

Cutting direction guidelines

Cutting direction is based on the fabric width and the way the fabric is cut from the roll and applied to Coalesse products. There are two cutting directions: railroaded or cut-right.

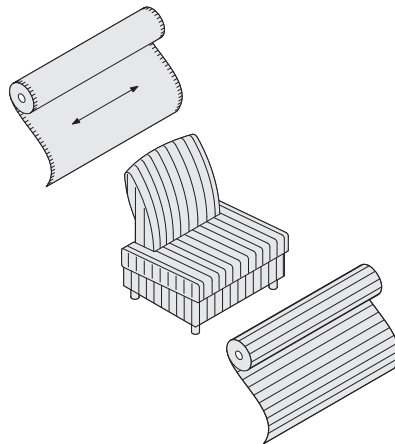

Horizontal or railroaded (across roll, warp horizontal) means fabric is cut across the roll; selvages are on the top and bottom.

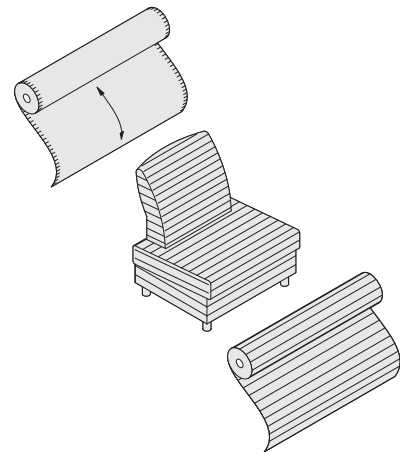

Vertical or cut-right (down roll, warp vertical) means fabric is cut in the same direction it is woven; selvages are on the left and right sides.

Coalesse reserves the right to railroad or apply fabric according to weave unless instructions specify otherwise. Fabrics are railroaded when possible to avoid seams in large upholstered areas and/or single cushion units. If a fabric is questionable, a cutting of adequate size showing full repeat (if any) should be sent to Coalesse for a fabric requirement quotation.

Coalesse

Archipelago Multi-Fabric Yardage

DESIGN METRO DESIGN GROUP WITH EIGHT INC.

Astor

DESIGN EDGAR REUTER DESIGN ORIGIN: GERMANY

 = Available in Rapid10.

Tip: All cushions are loose.

Tip: Fabrics and leathers will appear loose with comfort wrinkles when upholstered.

Tip: Recommended leathers are Elmosoft Grade C and Elmorustical Grade E.

Tip: Special color match, consult customer service.

Tip: For Customer's Own Material or Leather, see necessary requirements, important processing instructions, and ordering information
 ▶ See Coalesse Surface Materials Reference Guide.

Standard Includes		Required to Specify	
	<ul style="list-style-type: none"> Chair or sofa: <ul style="list-style-type: none"> - Seat, back, and fully upholstered arms: fabric or leather - Legs: wood - Glides: non-adjustable - Pillow: fabric 		1 Style number 2 Number of fabrics if contrasting fabric style number is selected 3 Fabric or leather color number 4 Wood color number for legs ▶ See Coalesse Surface Materials Reference Guide. 5 Options, if selected (see below) ▶ See Coalesse Surface Materials Reference Guide.
Options		U.S. Price	Required to Specify
Surface Materials	<ul style="list-style-type: none"> Contrasting fabric 	+\$113 per fabric	Add suffix K to the style number and select fabric color number.
	Fire code seating		Specify with CAL 133.
	<ul style="list-style-type: none"> CAL 133 for chair CAL 133 for two-seat sofa CAL 133 for three-seat sofa 	+\$218 +\$437 +\$568	Specify with CAL 133. ▶ See Coalesse Surface Materials Reference Guide.
	Acrylic backer		Specify with acrylic backer.
	<ul style="list-style-type: none"> Backer for chair Backer for two-seat sofa Backer for three-seat sofa Backer for arm pillow 	+\$ 46 +\$ 81 +\$ 87 +\$ 12	Specify with acrylic backer. ▶ See Coalesse Surface Materials Reference Guide.
Attachment Straps	<ul style="list-style-type: none"> Cushion attachment straps (318) Cushion attachment straps (318-2) Cushion attachment straps (318-3) Pillow attachment straps (318-A) 	+\$118 +\$236 +\$354 +\$ 59	Specify with cushion attachment straps. Specify with cushion attachment straps. Specify with cushion attachment straps. Specify with pillow attachment straps.

Specification Information

Style Number	U.S. Base Prices										Leather Grades:		
	Fabric Grades:										COL	C	E
	COM	6	7	8	9	10	11	12	13	14			

Chair

	318	\$1775	\$2003	\$2056	\$2109	\$2322	\$2558	\$2760	\$2949	\$3043	\$3146	\$2041	\$4136	\$4727
		COM/yds = 5¼, COL/sq ft = 116												

Two-Seat Sofa

	318-2	\$2749	\$3096	\$3155	\$3237	\$3438	\$3787	\$4070	\$4294	\$4418	\$4619	\$3015	\$6003	\$6759
		COM/yds = 8, COL/sq ft = 176												

▶ Specification Information, continued on next page

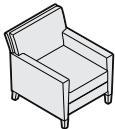

Overall: 34"D 30½"W 32"H
 Inside: 20"D 22"W 17"H
 Seat: 17"H
 Arm: 22"H

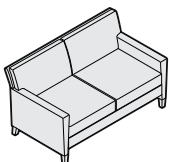

Overall: 34"D 63"W 32"H
 Inside: 20"D 55"W 17"H
 Seat: 17"H
 Arm: 22"H



For Canadian Pricing
 Multiply U.S. Price by the Canadian price factor.
 ▶ See page 1 for details.

Coalesse

Astor

DESIGN EDGAR REUTER DESIGN ORIGIN: GERMANY

 = Available in Rapid10.

► Specification Information, continued from previous page

Specification Information

Style Number	U.S. Base Prices													
	Fabric Grades:											Leather Grades:		
	COM	6	7	8	9	10	11	12	13	14	COL	C	E	

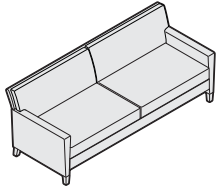

Overall: 34"D 76"W 32"H
 Inside: 20"D 68"W 17"H
 Seat: 17"H
 Arm: 22"H



Three-Seat Sofa

318-3	\$3690	\$4131	\$4184	\$4297	\$4545	\$4958	\$5306	\$5561	\$5752	\$6044	\$3968	\$7558	\$8433
--------------	--------	--------	--------	--------	--------	--------	--------	--------	--------	--------	--------	--------	--------

COM/yds = 9½, COL/sq ft = 209



Overall: 21"D 4"W 13"H



Arm Pillow

318-A	\$ 215	\$ 236	\$ 241	\$ 256	\$ 279	\$ 325	\$ 362	\$ 390	\$ 402	\$ 417	\$ 493	\$ 780	\$1046
--------------	--------	--------	--------	--------	--------	--------	--------	--------	--------	--------	--------	--------	--------

COM/yds = 1, COL/sq ft = 18

Lounge Seating

For Canadian Pricing
 Multiply U.S. Price by the
 Canadian price factor.
 ► See page 1 for details.

Await Modular

DESIGN EOOS DESIGN ORIGIN: GERMANY

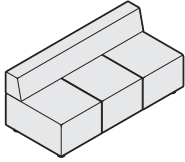

Tip: Recommended leathers are Elmosoft Grade C and Elmorustical Grade E.

Tip: Special color match, consult customer service.

Tip: For Customer's Own Material or Leather, see necessary requirements, important processing instructions, and ordering information
 ► See *Coalesse Surface Materials Reference Guide*.

Tip: Contrasting option available only on sofas.

Tip: Please include sketch for ganging.

Tip: Fabrics and leathers will appear loose with comfort wrinkles when upholstered.

Standard Includes		Required to Specify	
	<ul style="list-style-type: none"> • Frame: unibody construction with finger-jointed plywood • Multiple densities of polyurethane foam and polyester foam and polyester fiber • Sofa: <ul style="list-style-type: none"> - Seat and back: fabric or leather - Legs: black high-density polyurethane resin - Glides: non-adjustable • Ottoman: <ul style="list-style-type: none"> - Seat: fabric or leather - Casters: non-locking 		<ol style="list-style-type: none"> 1 Style number 2 Number of fabrics if contrasting fabric style number is selected 3 Fabric or leather color number for upholstery on seat and back 4 Options, if selected (see below) ► See <i>Coalesse Surface Materials Reference Guide</i> .
Options		U.S. Price	Required to Specify
Surface Materials	• Contrasting fabric	+\$113 per fabric	Add suffix K to the style number and select fabric color number.
	Fire code seating		
	• CAL 133 for three-seat sofa, four-seat sofa, and bench	+\$568	Specify with CAL 133.
	• CAL 133 for ottoman	+\$218	Specify with CAL 133. ► See <i>Coalesse Surface Materials Reference Guide</i> .
Acrylic backer			
• Backer for three-seat sofa	+\$ 52	Specify with acrylic backer.	
• Backer for four-seat sofa	+\$ 64	Specify with acrylic backer.	
• Backer for four-seat bench	+\$ 44	Specify with acrylic backer.	
• Backer for ottoman	+\$ 15	Specify with acrylic backer. ► See <i>Coalesse Surface Materials Reference Guide</i> .	
Floor Mount Legs	• Floor mount legs	+\$113 per unit	Specify with floor mount legs



For Canadian Pricing
 Multiply U.S. Price by the Canadian price factor.
 ► See page 1 for details.

Await Modular

DESIGN EOOS DESIGN ORIGIN: GERMANY

Specification Information

Style Number	U.S. Base Prices													
	Fabric Grades:													
	COM	6	7	8	9	10	11	12	13	14	Leather Grades:			
											COL	C	E	

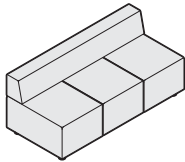

Overall: 30"D 66"W 27"H
 Inside: 22"D 66"W 27"H
 Seat: 16½"H
 Arm: 10½"H

Three-Seat Sofa

460-3	\$2992	\$3119	\$3173	\$3214	\$3298	\$3363	\$3569	\$3705	\$3910	\$4271	\$3227	\$5731	\$6180
-------	--------	--------	--------	--------	--------	--------	--------	--------	--------	--------	--------	--------	--------

COM/yds = 5¾, COL/sq ft = 147

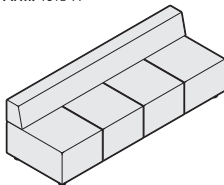

Overall: 30"D 88"W 27"H
 Inside: 22"D 88"W 27"H
 Seat: 16½"H
 Arm: 10½"H

Four-Seat Sofa

460-4	\$3671	\$3840	\$3910	\$3963	\$4064	\$4147	\$4408	\$4579	\$4840	\$5279	\$3906	\$7077	\$7639
-------	--------	--------	--------	--------	--------	--------	--------	--------	--------	--------	--------	--------	--------

COM/yds = 7¼, COL/sq ft = 185

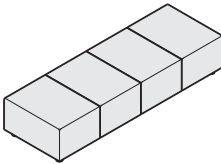

Overall: 30"D 88"W 16½"H
 Seat: 16½"H

Four-Seat Bench

460-4B	\$2697	\$2819	\$2872	\$2908	\$2984	\$3050	\$3244	\$3374	\$3575	\$3893	\$2932	\$5329	\$5755
--------	--------	--------	--------	--------	--------	--------	--------	--------	--------	--------	--------	--------	--------

COM/yds = 5½, COL/sq ft = 100



Overall: 22"D 22"W 16½"H

Ottoman/Mobile

460-H	\$ 683	\$ 693	\$ 704	\$ 716	\$ 734	\$ 752	\$ 805	\$ 841	\$ 895	\$ 968	\$ 918	\$1549	\$1662
-------	--------	--------	--------	--------	--------	--------	--------	--------	--------	--------	--------	--------	--------

COM/yds = 1½, COL/sq ft = 33

Lounge Seating



For Canadian Pricing
 Multiply U.S. Price by the
 Canadian price factor.
 ▶ See page 1 for details.

Await Connector Benches

DESIGN EOOS DESIGN ORIGIN: GERMANY

 = Available in Rapid10.

Tip: Recommended leathers are Elmosoft Grade C and Elmorustical Grade E.

Tip: Special color match, consult customer service.

Tip: For Customer's Own Material or Leather, see necessary requirements, important processing instructions, and ordering information
 ► See *Coalesse Surface Materials Reference Guide*.

Tip: Please include sketch for ganging.

Tip: Fabrics and leathers will appear loose with comfort wrinkles when upholstered.

Standard Includes		Required to Specify	
	<ul style="list-style-type: none"> Bench: fabric or leather Frame: unibody construction with finger-jointed plywood Multiple densities of polyurethane foam Fixed seat Top and double needle stitching on seams Legs: black high-density polyurethane resin Glides 		1 Style number 2 Fabric or leather color number for upholstery on bench 3 Options, if selected (see below) ► See <i>Coalesse Surface Materials Reference Guide</i> .
Options		U.S. Price	Required to Specify
Surface Materials	• Fire code seating		
	• CAL 133 for one-section connector bench	+\$218	Specify with CAL 133.
	• CAL 133 for two-section connector bench	+\$437	Specify with CAL 133.
	• CAL 133 for three-section connector bench	+\$568	Specify with CAL 133. ► See <i>Coalesse Surface Materials Reference Guide</i> .
	Acrylic backer		
	• Backer for one-section connector bench	+\$ 21	Specify with acrylic backer.
	• Backer for two-section connector bench	+\$ 31	Specify with acrylic backer.
	• Backer for three-section connector bench	+\$ 46	Specify with acrylic backer. ► See <i>Coalesse Surface Materials Reference Guide</i> .
Floor Mount Legs	• Field-installed floor mount legs	+\$113 per unit	Specify with floor mount legs.

Specification Information														
Style Number	U.S. Base Prices												Leather Grades:	
	Fabric Grades:												COL	C
COM	6	7	8	9	10	11	12	13	14					

One-Section Connector Bench

461-1B	\$1244	\$1270	\$1295	\$1313	\$1343	\$1366	\$1450	\$1503	\$1580	\$1728	\$1479	\$2442	\$2613
COM/yds = 2¼, COL/sq ft = 53													

Two-Section Connector Bench

 461-2B	\$1881	\$1950	\$1985	\$2014	\$2067	\$2109	\$2245	\$2333	\$2466	\$2688	\$2116	\$3739	\$4030
COM/yds = 3¾, COL/sq ft = 83													

Three-Section Connector Bench

 461-3B	\$2602	\$2718	\$2765	\$2801	\$2878	\$2936	\$3126	\$3248	\$3437	\$3746	\$2837	\$5123	\$5530
COM/yds = 5, COL/sq ft = 110													

Ganging Kit

 460-GANGPKG	\$ 42
--	-------

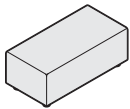

Overall: 44"D 22"W 16½"H

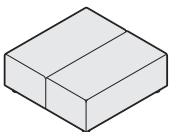

Overall: 44"D 44"W 16½"H

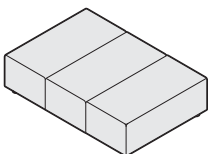

Overall: 44"D 66"W 16½"H

Await Tables

DESIGN EOOS DESIGN ORIGIN: GERMANY

 = Available in Rapid10.

Tip: Await connector tables are not recommended to be used in end-of-run applications.

Tip: Await connector tables are not made for ganging to Await mobile ottoman.

Standard Includes	Required to Specify
-------------------	---------------------

- Freestanding table frame: silver
- Connector table frame: panels are black, white, or gray
- Top: High-Pressure Laminate top with matching 3 mm edge band
- Glass top (tablet):
 - 1/2" thick
 - Radiused edges
- Ganging plate: 1/4" thick ganging plates attach to the bottom of units to the seating unit plates

- 1 Style number
- 2 Laminate top and tablets, if selected:
 - 2595 Black
 - 2730 Arctic White
 - 2906 North Sea
- 3 Glass color number for top, if selected
 - ▶ See *Coalesse Surface Materials Reference Guide*.

Specification Information

Style Number	U.S. Prices			
	Top Surface:			
	Laminate	Clear Green/ Clear Green Frosted Glass Top	Absolute Clear/ Clear Frosted Glass Top	Colored Glass Top

Freestanding Low Round Table

 46-T1	\$ 969	\$1159	\$1180	\$1337
---	--------	--------	--------	--------

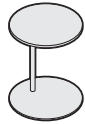

Overall: 15 3/4" Dia. 19"H

Freestanding High Round Table

 46-T2	\$1265	\$1455	\$1476	\$1633
--	--------	--------	--------	--------



Overall: 15 3/4" Dia. 25"H

Specification Information

Style Number	U.S. Prices								
	Laminate Top:			Glass Tablet:					
	No Tablet	Tablet	Power/Data	Clear Green/ Clear Green Frosted Glass Tablet	Clear Green/ Clear Green Frosted Tablet and Power/Data	Absolute Clear/ Clear Frosted Glass Tablet	Absolute Clear/ Clear Frosted Tablet and Power/Data	Colored Glass Tablet	Colored Tablet and Power/Data

Connector Tables

460-SE22	\$597	\$1371	N.A.	\$1471	N.A.	\$1493	N.A.	\$1650	N.A.
460-SE22PD	N.A.	N.A.	\$1630	N.A.	\$1731	N.A.	\$1752	N.A.	\$1908

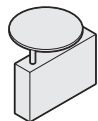

Overall: 20"D 4 1/2"W 15 3/4"H
With Tablet: 15 3/4" Dia. and 25 3/8"H

460-SE30	\$684	\$1458	N.A.	\$1558	N.A.	\$1584	N.A.	\$1737	N.A.
460-SE30PD	N.A.	N.A.	\$1720	N.A.	\$1821	N.A.	\$1842	N.A.	\$1998

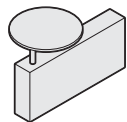

Overall: 28"D 4 1/2"W 15 3/4"H
With Tablet: 15 3/4" Dia. and 25 3/8"H

460-SE44	\$839	\$2387	N.A.	\$2515	N.A.	\$2559	N.A.	\$2867	N.A.
460-SE44PD	N.A.	N.A.	\$2642	N.A.	\$2777	N.A.	\$2819	N.A.	\$3133

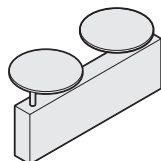

Overall: 42"D 4 1/2"W 25 3/8"H
With Tablets: 15 3/4" Dia. and 25 3/8"H

Await Ganging Diagrams by Model (Underside View)

DESIGN EOOS DESIGN ORIGIN: GERMANY

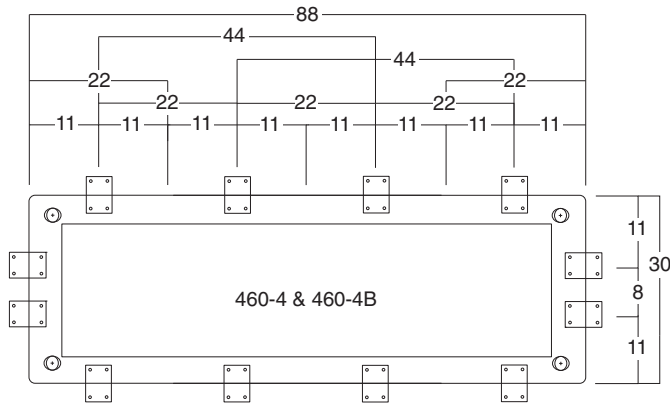
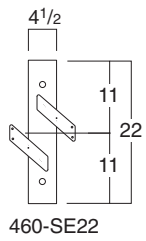
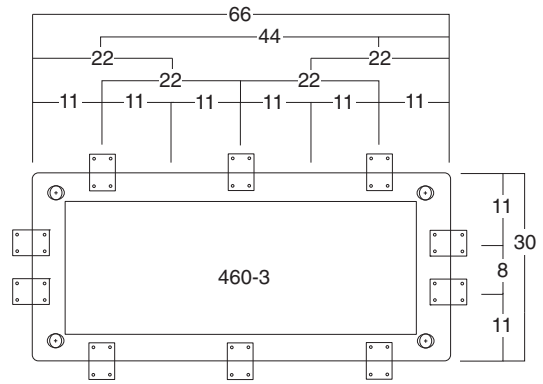
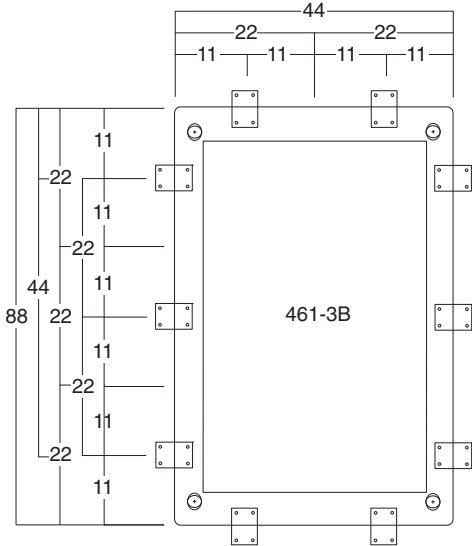
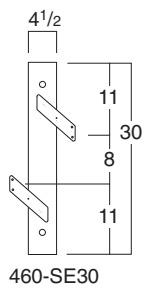
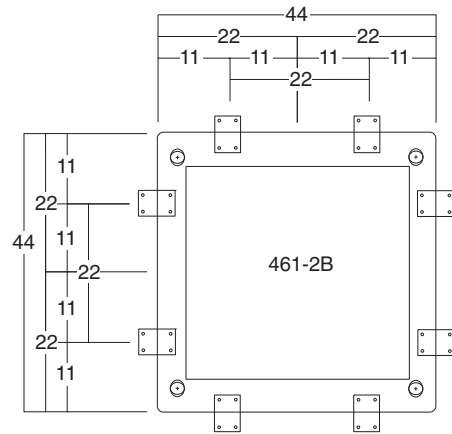
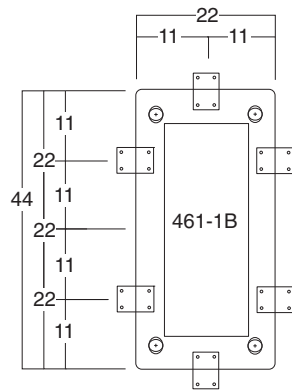
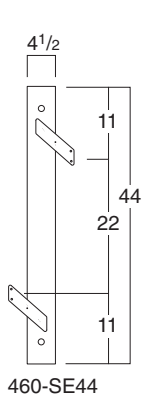

Await Multi-Fabric Diagram

TO: _____

FROM: _____

DATE: _____

FAX....888.413.5161

A Seat (upholstery selections default for entire unit if B is not selected):

B Back: _____

\$113 U.S. list per contrasting fabric specified. List price based on highest fabric grade usage.

Specify Model below:

460-3K

460-4K

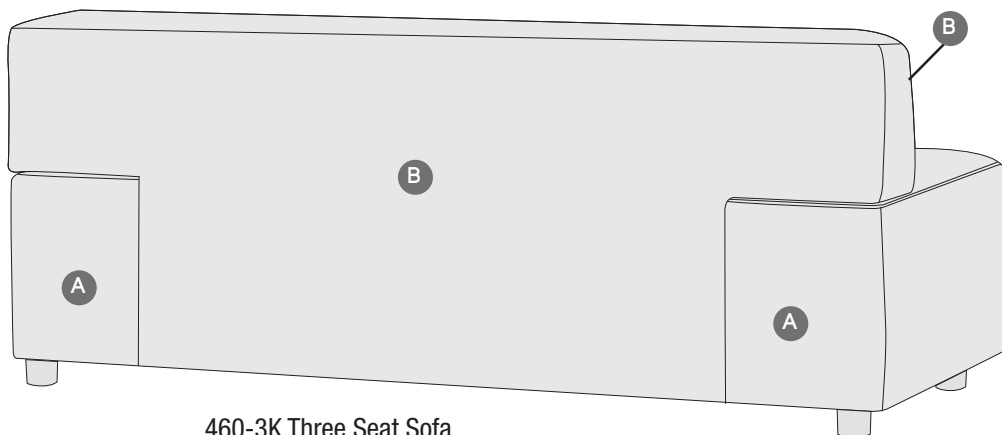
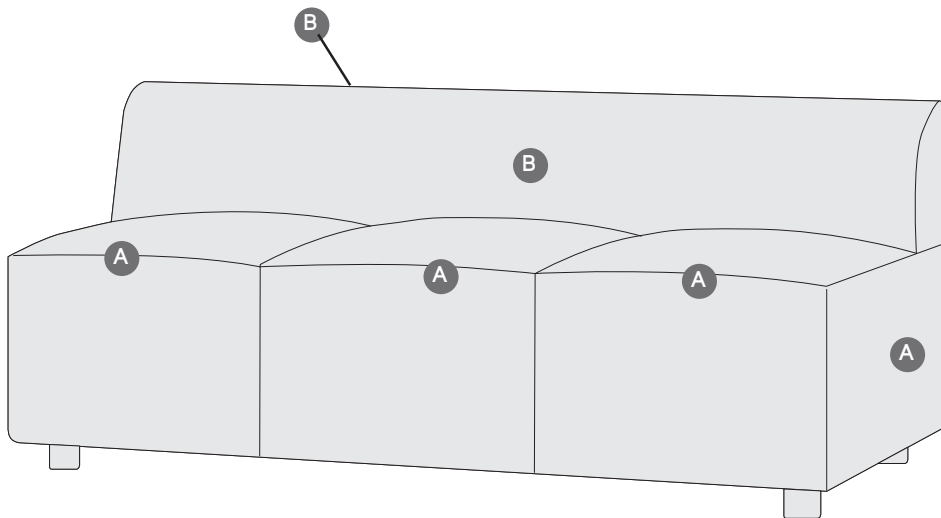

460-3K Three Seat Sofa



For Canadian Pricing
Multiply U.S. Price by the
Canadian price factor.
▶ See page 1 for details.

Bix

DESIGN METRO DESIGN GROUP

Bix offers a system of seating and tables that can create a variety of lounge-based applications that address group or individual work needs. Each application provides convenient connections to power, voice, and data.

Group meeting area created with Bix furniture offers a sense of enclosure without walls for collaborating and provides social and physical comfort.

Back screen is available on select units to provide privacy and divide space. It is upholstered.

Seat is upholstered.

Arms are available on select seating units. They are upholstered.

Back is upholstered.

Sled base on a lounge chair is finished with paint. The back of the sled base does not extend past the chair back.

Side table offers a freestanding mobile tablet surface. It is available in vinyl.

Projection screen is available on podium seating for presentations and to divide space. It also accommodates Steelcase huddleboards.

Bolster is upholstered.

Storage drawer is available on select models to store equipment or presentation tools.

Face lock, keyed randomly, is standard on storage drawers to secure the items stored in it.

Legs and base are constructed with steel tubing and steel plates for structural integrity. They are finished with paint. They are either inset under the seating unit (sled base) or slant off the back of a unit (legs).

Tablet provides a surface for presenter's notes, laptop computer, or wireless mouse.

Leveling glides adjust for installations on uneven floors. Adjustability range is 3/4".

Service tray is optional.

Actual Dimensions
▶ See page 76

Product Details

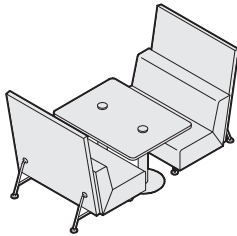

Individual work-booth area provides an alternative to a confined workstation. It offers a semi-private setting for temporary tasks that require projects to be spread out. It is created by grouping two straight sectionals or lounge chairs with a 27"H work-booth table.

Tip: Extended corner sectionals or straight sections with arms should not be used in a work-booth application because access to the seating area is obstructed.

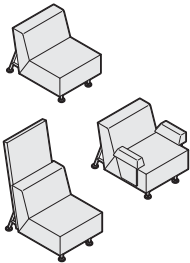

Lounge chairs are available with or without upholstered back screens. Models with upholstered arms are also available.

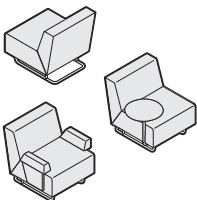

Sled lounge chairs feature a compact base that is designed for small spaces or to be used flush against the wall. They are available with or without upholstered arms or a tablet arm.

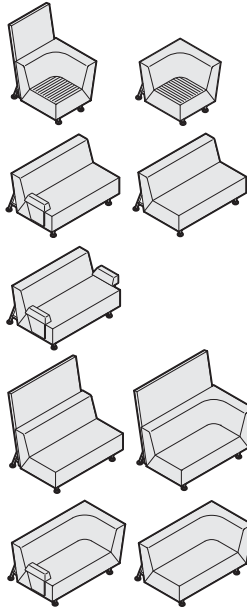

Sectional seating is offered in corner, extended corner, and straight units to provide a variety of configurations. They are offered with or without back screens and with or without arms. All sections include an integrated ganging device. Corner sectional units are handed. Handedness is determined by the location of the back screen or back support legs.

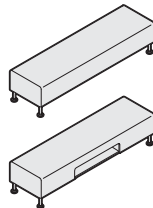

Bench provides a backless seating option. It can also be used as an alternative soft occasional table. An open storage space that is accessible from either side is available for storing magazine and media equipment. Bench can accommodate a service tray.

18" seat height is an available option on all lounge, sectional seating, bench, and podiums. This option should not be used in conjunction with work booth tables. It allows a higher sit for healthcare applications.

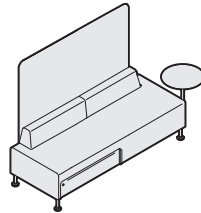

Podium serves as a focal point for lounge-based meeting spaces and provides comfortable seating for the presenter. A lockable storage drawer secures projection equipment or presentation tools. A fixed tablet arm provides a surface for presenter's notes, laptop computer, or wireless mouse. Podium can accommodate a service tray.

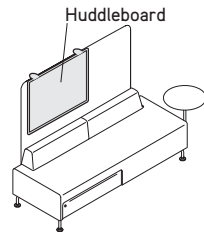

Integrated projection screen is available on select podium units for slides or projected digital media. It can also be used to divide an open space. The screen is a fine white mesh that allows light to filter through when the screen is used as a space divider. It also accommodates a Steelcase huddleboard.

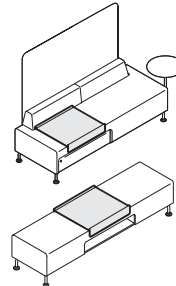

Service tray rests on benches and podium units for food service or to support projection equipment in a lounge-base meeting space.

Multiple fabrics can be specified on lounge, sectional, and podium seating units for an additional fee per specified fabric.

- Seat cushion and sides of seat cushion - no additional fee
- Back cushion and sides of back cushion - additional fee
- Back screen (if selected) - no additional fee
- Armrest (if selected) - no additional fee

► See *Bix Multi-Fabric Diagram and Yardage Request Form*, pages 89 and 94

Tip: Fabric for the seat and back is specified separate from the back screen, if selected. For a monochromatic look, specify the same fabric for both the seat and back and back screen.

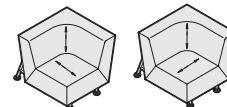

30"W corner sectional units are available with the two fabric direction options for the seat - railroaded or cut-right. Seat fabric direction is determined by its relationship to the back screen or back support legs.

Tip: Seat fabric on extended corner and straight sections is always railroaded.

► Page 96

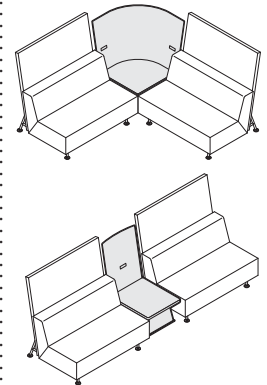

Bridge tables integrate with Bix sectional seating to create a range of lounge-based applications and are available with two top shapes - rectangular and corner. Translucent screens are available to create a sense of visual privacy for open space environments. The worksurface is available with or without a grommet and an optional power, voice, and data module. The rectangular table features an integrated 18"W x 12 1/2"H tilted display surface for magazines or project folders. *Tip: Bridge tables are used with sectional seating. They do not attach to benches or podiums.*

Corner bridge tables are offered in 20" table height option to be used with the 18" seat height option only.

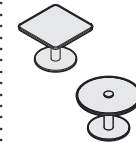

Occasional tables are freestanding 18"H tables that can be used a variety of lounge applications. They are available with a round, square, or rectangular top. The tops are available with or without a grommet and an optional power, voice, and data module.

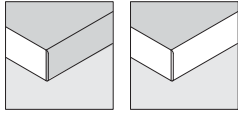

Plastic edge Wood edge

Edge detail is available in either plastic or wood edge.

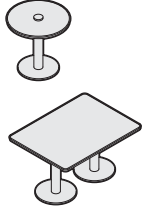

Work-booth tables are free-standing 27"H tables that are used with sectional seating to create a work-booth configuration. They are available with either a round or rectangular top. The tops are available with or without a grommet and an optional power, voice, and data module. Base features a low profile for foot clearance.



Side table offers a freestanding, mobile tablet surface. The tripod base allows it to be positioned close to a seating unit. The top is available in vinyl.



Back screen is available on lounge and sectional seating. It is fully upholstered with a zipper detail. However, it is not removable. Back screens must be ordered with the chair. It cannot be retrofitted to an existing backless lounge chair or seating sections.

Connections

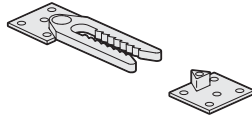

Integrated ganging device, included, connects sectional seating units together in the field. It is not intended for user reconfiguration.

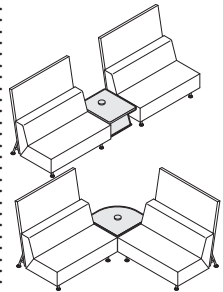

Bridge tables connect on both sides between sectional seating units. A rectangular top is used in an in-line configuration. A corner top is used in an L-shape configuration.

Exception: Bridge tables cannot attach to a seating unit with arms.

Lounge chairs are independent and are not intended to connect to sectional units or bridge tables.

► See How To Plan, page 78

Wiring & Cabling

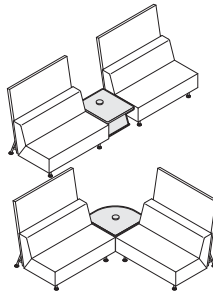

Bridge tables are available with a grommet, factory installed, to allow cords and cables to pass through the top. Wire management clips, attached to the underside of the top, are used to route cords and cables. A power, voice, and data module can be inserted in the grommet.

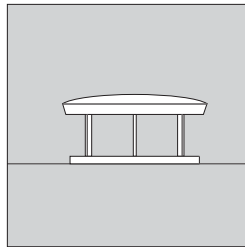
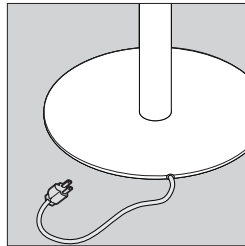

Occasional and work-booth tables are available with a factory-installed grommet located over each column and base to allow cords and cables to pass through the top. A power, voice, and data module can be inserted in each grommet location.

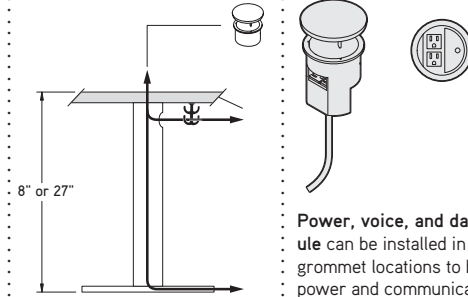

Column and base of occasional and work-booth tables are used to route and conceal cords. The cords pass through the worksurface down through the column and out through a mouse hole in the base plate. Bases may be installed with the mouse hole facing in any of four directions, depending upon where cords need to exit for access to power/data/voice in the wall or floor. Cords should be routed through the concealed channels and out the mouse hole during the installation of the table base.

Hole at the top of each column allows cords to be routed between tables directly below the worksurfaces. Wire management clips are included for routing purposes.

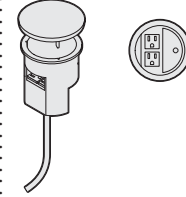

Power, voice, and data module can be installed in the grommet locations to bring power and communication to the worksurface. Each module is equipped with two 110volt electrical outlets and one snap-in voice/data module insert consisting of dual CAT 5 RJ45 universal T568A/B jacks. It is UL listed and CSA certified. It has a 6' power cord. For additional data/voice outlet options, please contact Metro customer service at 1.800.627.6770.

Hardwired applications require on-site modifications by a licensed electrician following all local electrical code requirements.

Tip: The base will accommodate a 3/8" diameter flex-conduit.

Bix

DESIGN METRO DESIGN GROUP

Surface Materials

Seat and back

- Fabric

Arms

- Fabric

Bolster

- Fabric

Legs

- Paint

Sled base

- Paint

Glides

- Paint and nylon bottom

Back screen

- Fabric

Projection screen

- White mesh only

Projection screen frame

- Paint

Tablet surface

- Dark gray vinyl only

Tablet support

- Paint

Open storage interior

- Paint

Storage drawer front

- Laminate (standard)
- Wood (option), high sheen only
- Custom wood finish (option), high sheen only

Integrated storage drawer pull

- Paint

Service tray frame

- Paint

Bridge, occasional, and work-booth table surface

- Laminate with matching 3 mm plastic edge
- Wood with matching wood edge
- Custom wood finish (option)

Bridge table frame and tilted display surface

- Paint

Bridge table screen

- Translucent material

Occasional and work-booth table base

- Paint (textured only)

Grommet

- Black plastic only

Side table surface and base cover

- Dark gray vinyl

Side table base

- Paint (vinyl)

Note: Refer to the Coalesse Surface Materials Reference Guide for additional surface materials information.

Programs & Services

Fire code seating (FCS) modifications are available to meet CAL TB133 requirements.

► See *Coalesse Surface Materials Reference Guide*.

Customer's Own

Material/Leather (COM/COL) Program is available.

► See *Coalesse Surface Materials Reference Guide* for additional information,

Note: Due to unusual upholstery conditions inherent in the design of Bix, not all seating fabrics may be specified. Refer to www.metrofurniture.com for a list of pre-approved Designtex fabrics on Bix. Pre-approval is required for all COM fabric.

Also, due to the geometric shapes and flat planes of the Bix design, seat fabric tautness will vary depending upon the amount of stretch in the fabric. Leather naturally stretches with use.

Designers

Metro Design Group | San Francisco

Actual Dimensions

	Overall Depth	Width	Height	Seat Depth	Width	Seat Height From Floor	Back Height From Seat	Arm Height
Lounge	38½"	26" or 30"	29" or 31"	19½"	26"	16" or 18"	13½"	22"
Sled lounge	30½"	26", 30", or 36½"	29"	19½"	26"	16"	13½"	22"
Sled lounge tablet arm	17" Dia.	N.A.	N.A.	N.A.	N.A.	N.A.	N.A.	N.A.
Corner sectional	38½"	30"	29" or 31" 49½" or 51½"	19½"	19½"	16" or 18"	13½"	N.A.
Extended corner sectional	38½"	54" or 56"	29" or 31" 49½" or 51½"	19½"	48" or 72"	16" or 18"	13½"	22½"
Straight sectional, no arms	38½"	48" or 72"	29" or 31" 49½" or 51½"	19½"	48" or 72"	16" or 18"	13½"	N.A.
Straight sectional, one arm	38½"	50" or 74"	29" or 31" 49½" or 51½"	19½"	48" or 72"	16" or 18"	13½"	22½"
Straight sectional, two arms	38½"	52" or 76"	29" or 31"	19½"	48" or 72"	16" or 18"	13½"	22½"
Back screen	1¾"	23½", 45½", 51½", or 69"	49" or 51"	N.A.	N.A.	N.A.	N.A.	N.A.
Bench	19½"	48" or 72"	16" or 18"	N.A.	N.A.	16" or 18"	N.A.	N.A.
Podium	26½"	81⅞" Includes tablet	25" or 27" 52" or 54"	19½"	N.A.	16" or 18"	7" or 34"	N.A.
Podium tablet arm	17" Dia.	N.A.	26"	N.A.	N.A.	N.A.	N.A.	N.A.
Projection screen	N.A.	59"	27"	N.A.	N.A.	N.A.	N.A.	N.A.
Service tray	20"	22"	4"	N.A.	N.A.	N.A.	N.A.	N.A.
Service tray mat area	18¼"	21½"	N.A.	N.A.	N.A.	N.A.	N.A.	N.A.
Rectangular bridge table	26"	22"	18" or 46"	N.A.	N.A.	N.A.	N.A.	N.A.
Corner bridge tables	26"	26"	18" or 20" 46" or 48"	N.A.	N.A.	N.A.	N.A.	N.A.
Bridge table screen	N.A.	22"	46"	N.A.	N.A.	N.A.	N.A.	N.A.
Round occasional tables	20" or 28" Dia.	N.A.	18"	N.A.	N.A.	N.A.	N.A.	N.A.
Square occasional tables	24"	24"	18"	N.A.	N.A.	N.A.	N.A.	N.A.
Rectangular occasional tables	24"	48" or 72"	18"	N.A.	N.A.	N.A.	N.A.	N.A.
Occasional table base	18" Dia.	N.A.	N.A.	N.A.	N.A.	N.A.	N.A.	N.A.
Occasional table column	4" Dia.	N.A.	N.A.	N.A.	N.A.	N.A.	N.A.	N.A.
Round work-booth tables	20" or 28" Dia.	N.A.	27"	N.A.	N.A.	N.A.	N.A.	N.A.
Rectangular work-booth tables	36"	48" or 72"	27"	N.A.	N.A.	N.A.	N.A.	N.A.
Side table	17" Dia.	N.A.	23"	N.A.	N.A.	N.A.	N.A.	N.A.

Coalesse

Bix

DESIGN METRO DESIGN GROUP

Bix How To Plan

DESIGN METRO DESIGN GROUP

Configuration guidelines — work settings with podium, benches & bridge tables

A variety of configurations may be created to support lounge-based meeting spaces using the Bix podium as a focal point. Benches and bridge tables support media projection equipment. As projection equipment varies, you will need to verify the distance required between the equipment and projection screen when planning your space. The examples below are suggested layouts.

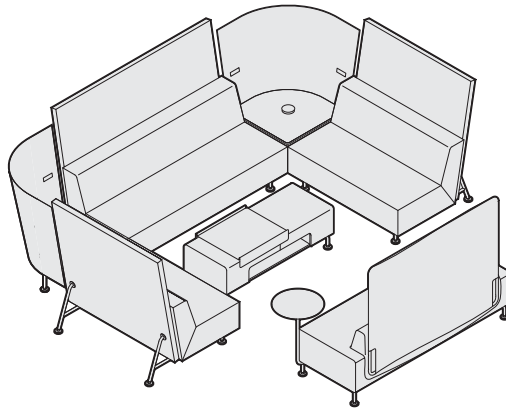

Configuration Examples

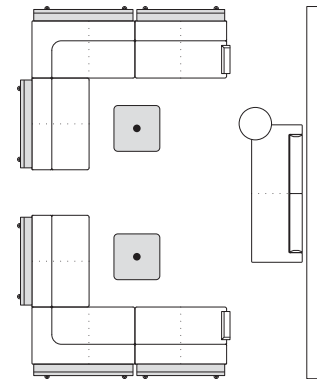
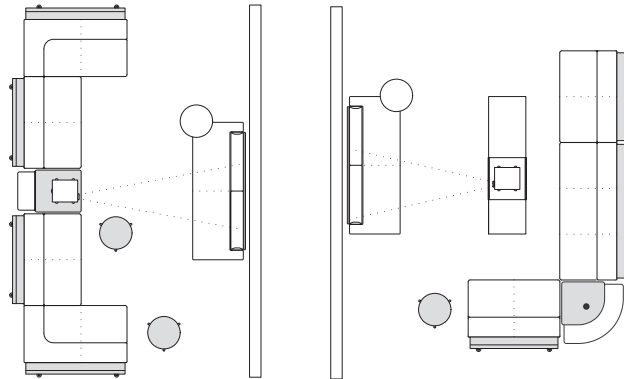
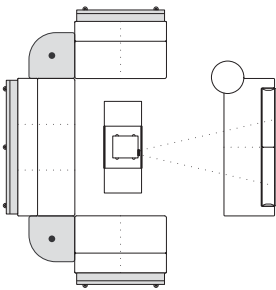
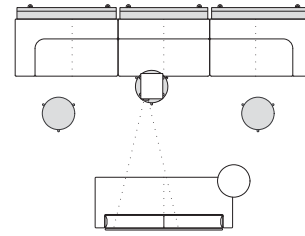
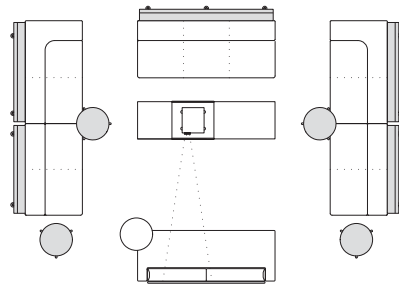
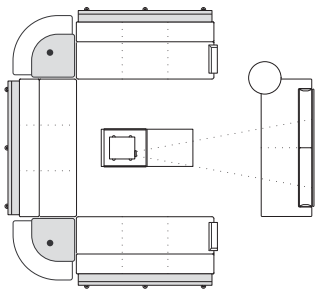

Bix How To Plan

DESIGN METRO DESIGN GROUP

Configuration guidelines –
work-booths with 27" high tables

Two straight sections are grouped with 27" high tables to create work-booth applications. Lounge chairs may also be specified with 27" high tables to create a two-person work-booth. Facing seats edges should be spaced 24"-27" apart from one another to accommodate leg clearance and maintain the correct user relationship to the worksurface. The table base is centered within the 24"-27" space.

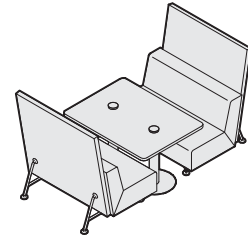

Configuration Examples

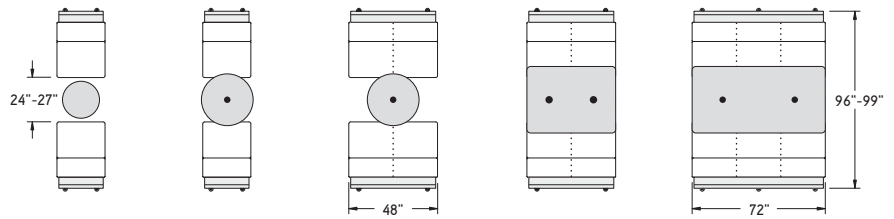

Configuration guidelines –
work settings with 18" high tables

A variety of configurations may be created by combining sectional seating and 18" high tables. The Bix system is built upon a 12"/24" dimension module for planning. Seats are 24" wide. Rectangular tables are 24" deep. Tables are spaced 12" from seat edges. A 24" opening should be maintained for large 360° group enclaves.

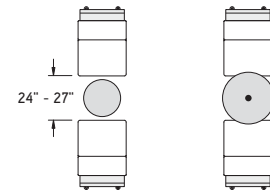

Configuration Examples

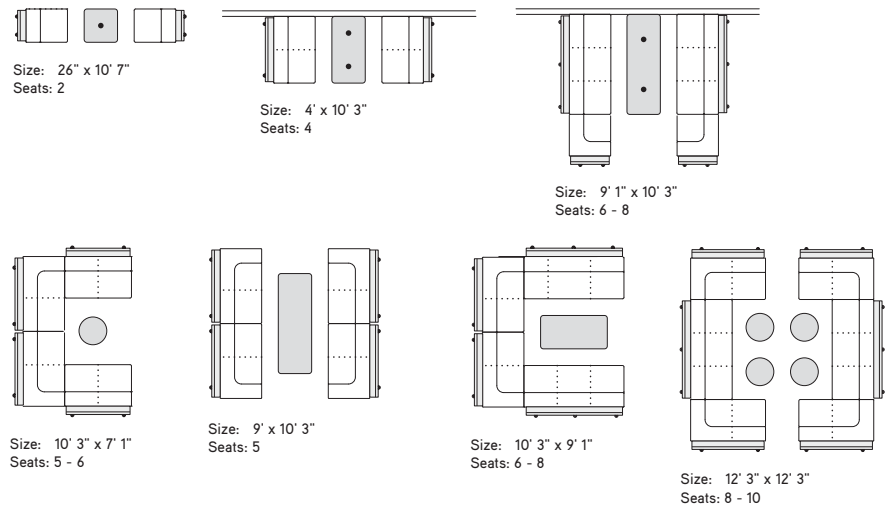

Bix How To Plan *continued*

DESIGN METRO DESIGN GROUP

Configuration guidelines – DON'TS

- 30" wide corner sections are not intended to be freestanding. 30" wide corner sections must always be connected to an adjoining 54" wide extended corner or straight section, using the ganging hardware provided.

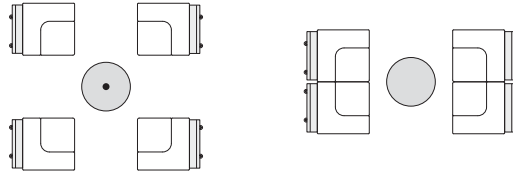

- Individual lounge chairs are independent elements not designed as a module within the seating system. The lounge chair seat is wider than the 24" system module and lounge chairs do not include ganging hardware. Bridge tables also do not connect to lounge chairs.

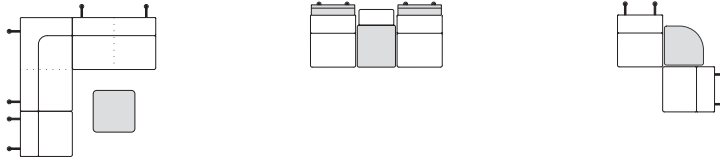

- Do not create a U-shaped configuration with a 27" high rectangular table. Access to the closed end is difficult and the table edge is too far from reach for the user.

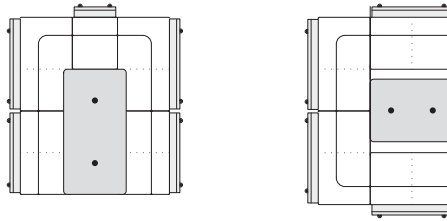

- Do not use 54" wide extended corner sections or straight sections with arms to create a work-booth configuration with 27" high tables. Access is obstructed.

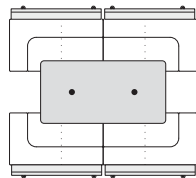

- Bridge tables must be connected on both sides to a seating section.



- Bridge tables do not connect to seating sections with arms. Seating sections do not gang with arms at the seam.

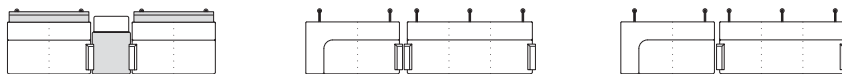

- Do not attach 30" wide corner sections to a corner bridge table. This application does not allow enough leg room for two users.

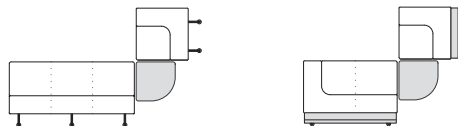

- Bridge tables do not attach to benches or podiums.



Bix How To Plan

DESIGN METRO DESIGN GROUP

Orientation & fabric direction

Corner units are handed from a facing position. Handedness for 30"W corner units is determined by the location of the back-screen or back support legs. Location of back-screens should be considered for each configuration. In order to create a consistent pattern across seats in the configuration,

30"W corner units are available with two seat fabric direction options. Seat fabric direction is determined by its relationship to the back-screen or back support legs. Seat and back fabric on 54"W extended corner and straight sections is always railroaded.

Examples below assume a striped patterned fabric:

30"W Corner Sections

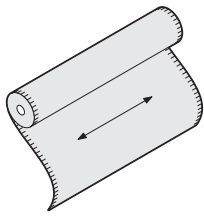

Arrow indicates direction of the pattern on the roll

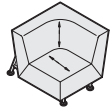

Left-hand, fabric railroaded BSC30LA

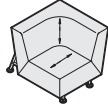

Left-hand, fabric cut-right BSC30LB

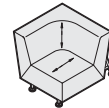

Right-hand, fabric railroaded BSC30RA

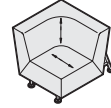

Right-hand, fabric cut-right BSC30RB

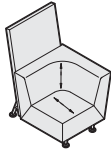

Left-hand, fabric railroaded BSCB30LA

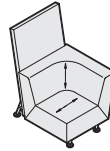

Left-hand, fabric cut-right BSCB30LB

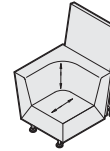

Right-hand, fabric railroaded BSCB30RA

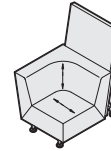

Right-hand, fabric cut-right BSCB30RB

54"W Extended Corner and Straight Sections

Note: Seat and back fabric is always railroaded

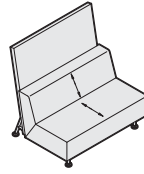
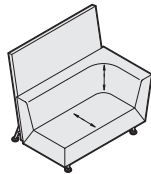

Configuration Examples

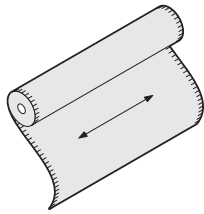

Arrow indicates direction of the pattern on the roll

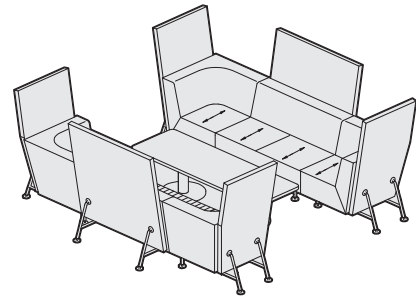
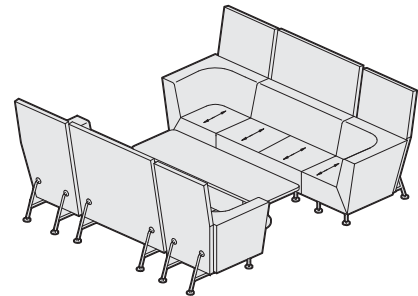
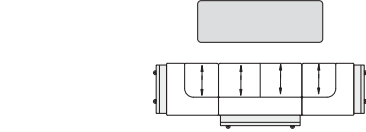
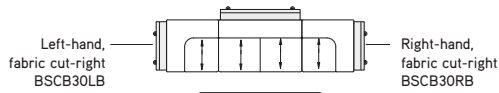
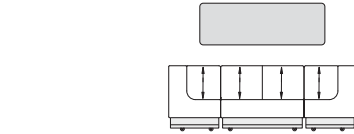
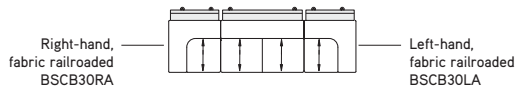

Bix Lounge Chairs

DESIGN METRO DESIGN GROUP

Tip: Fabric for the seat and back is specified separate from the back screen, if selected. For a monochromatic look, specify the same fabric for both the seat and back and back screen.

Tip: Fabrics and leathers will appear loose with comfort wrinkles when upholstered.

Tip: When specifying fabric in different price grades, the highest price grade prevails.

Tip: The COM yards and COL square footage listed on this page reflect the requirements for a single fabric that are based on non-directional 54"W material applied rail-roaded. For multi-fabric COM requirements, please refer to Multi-Fabric Yardage. ▶Page 95

Standard Includes		Required to Specify
▶ Need help? Product details, page 72	<ul style="list-style-type: none"> • Seat, back, and arms, if selected: fabric or leather • Legs: paint • Adjustable glides: paint to match legs • Back screen, if selected: fabric • Leveling wrench 	<ol style="list-style-type: none"> 1 Style number 2 Number of fabrics if contrasting fabric style number is selected 3 Fabric or leather color number for seat, back, and arms, if selected 4 Paint color number for legs and glides 5 Fabric color number for back screen, if selected 6 Options, if selected (see below) <p>▶ See <i>Coalesse Surface Materials Reference Guide</i>.</p>

Options	U.S. Price	Required to Specify
Surface Materials	<ul style="list-style-type: none"> • Contrasting fabric +\$113 per fabric 	Add suffix K to the style number and select fabric color number.
	Fire code seating	
	<ul style="list-style-type: none"> • CAL 133 for lounge chair +\$218 • CAL 133 for lounge chair with arms +\$285 • CAL 133 for lounge chair with back screen +\$437 	Specify with CAL 133. Specify with CAL 133. Specify with CAL 133. ▶ See <i>Coalesse Surface Materials Reference Guide</i> .
	Acrylic backer	
	<ul style="list-style-type: none"> • Backer for lounge chair +\$ 32 • Backer for lounge chair with arms +\$ 44 • Backer for lounge chair with back screen +\$ 54 	Specify with acrylic backer. Specify with acrylic backer. Specify with acrylic backer. ▶ See <i>Coalesse Surface Materials Reference Guide</i> .
Seat Height	<ul style="list-style-type: none"> • 18" seat height +\$212 	Specify with 18" seat height.
Related Products	<ul style="list-style-type: none"> • Sectional seating • Bench • Podium • Occasional tables • Work booth tables • Side tables 	<ul style="list-style-type: none"> ▶ Page 84 ▶ Page 90 ▶ Page 92 ▶ Page 100 ▶ Page 101 ▶ Page 102

Specification Information

Style Number	U.S. Base Prices													
	Fabric Grades:											Leather Grades:		
	COM	6	7	8	9	10	11	12	13	14	COL	C	E	

Lounge Chair

BL26XX	\$1539	\$1619	\$1660	\$1692	\$1768	\$1811	\$1847	\$1923	\$1958	\$2120	\$1734	\$2637	\$2799
COM/yds = 2 ³ / ₄ , COL/sq ft = 55													

Lounge Chair with Arms

BL26AA	\$2140	\$2264	\$2318	\$2361	\$2466	\$2524	\$2571	\$2677	\$2725	\$2946	\$2428	\$3422	\$3617
COM/yds = 3 ³ / ₄ , COL/sq ft = 73													

Lounge Chair with Back Screen

BLB26XX	\$2189	\$2346	\$2412	\$2461	\$2588	\$2658	\$2715	\$2842	\$2900	\$3164	\$2485	\$3838	\$4098
Chair: COM/yds = 2 ³ / ₄ , COL/sq ft = 55													
Screen: COM/yds = 1 ³ / ₄													

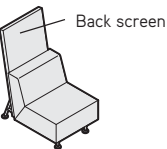
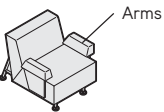
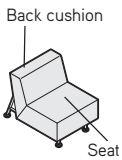

Bix Sled Lounge Chairs

DESIGN METRO DESIGN GROUP

Tip: The COM yards and COL square footage listed on this page reflect the requirements for a single fabric that are based on non-directional 54"W material applied rail-roaded. For multi-fabric COM requirements, please refer to Multi-Fabric Yardage.
▶ Page 95

Tip: When specifying fabric in different price grades, the highest price grade prevails.

Standard Includes		Required to Specify	
▶ Need help? Product details, page 72	<ul style="list-style-type: none"> • Seat, back, and arms, if selected: fabric or leather • Base and tablet support, if selected: paint • Glides • Tablet surface: dark gray vinyl only 	<ol style="list-style-type: none"> 1 Style number 2 Number of fabrics if contrasting fabric style number is selected 3 Fabric or leather color number for seat, back, and arms, if selected 4 Paint color number for base and tablet, if selected 5 Options, if selected (see below) 	▶ See <i>Coalesse Surface Materials Reference Guide</i> .

Options	U.S. Price	Required to Specify	
Surface Materials	<ul style="list-style-type: none"> • Contrasting fabric 	+\$113 per fabric	Add suffix K to the style number and select fabric color number.
	Fire code seating		
	<ul style="list-style-type: none"> • CAL 133 for lounge chair and lounge chair with tablet arm 	+\$218	Specify with CAL 133.
	<ul style="list-style-type: none"> • CAL 133 for lounge chair with arms 	+\$285	Specify with CAL 133. ▶ See <i>Coalesse Surface Materials Reference Guide</i> .
	Acrylic backer		
	<ul style="list-style-type: none"> • Backer for lounge chair and lounge chair with tablet arm 	+\$ 32	Specify with acrylic backer.
	<ul style="list-style-type: none"> • Backer for lounge chair with arms 	+\$ 44	Specify with acrylic backer. ▶ See <i>Coalesse Surface Materials Reference Guide</i> .
Related Products	<ul style="list-style-type: none"> • Bench • Podium • Occasional tables • Side tables 		▶ Page 90 ▶ Page 92 ▶ Page 100 ▶ Page 102

Specification Information

Style Number	U.S. Base Prices											Leather Grades:		
	Fabric Grades:											COL	C	E
	COM	6	7	8	9	10	11	12	13	14				

Sled Lounge Chair

BLD26XX	\$1369	\$1449	\$1490	\$1522	\$1598	\$1641	\$1677	\$1753	\$1788	\$1950	\$1499	\$2467	\$2629
COM/yds = 2¾, COL/sq ft = 55													

Sled Lounge Chair with Arms

BLD26AA	\$1971	\$2095	\$2149	\$2192	\$2297	\$2355	\$2402	\$2508	\$2556	\$2777	\$2158	\$3253	\$3448
COM/yds = 3¾, COL/sq ft = 73													

Sled Lounge Chair with Left-Hand Facing Tablet Arm

BLD26TX	\$1664	\$1744	\$1785	\$1817	\$1893	\$1936	\$1972	\$2048	\$2083	\$2245	\$1823	\$2762	\$2924
COM/yds = 2¾, COL/sq ft = 55													

Sled Lounge Chair with Right-Hand Facing Tablet Arm

BLD26XT	\$1664	\$1744	\$1785	\$1817	\$1893	\$1936	\$1972	\$2048	\$2083	\$2245	\$1823	\$2762	\$2924
COM/yds = 2¾, COL/sq ft = 55													

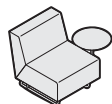
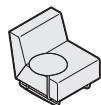
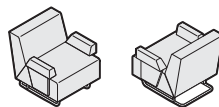
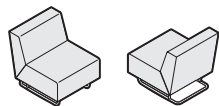

For Canadian Pricing
Multiply U.S. Price by the Canadian price factor.
▶ See page 1 for details.

Bix Sectional Seating

DESIGN METRO DESIGN GROUP

 = Available in Rapid10.

Tip: Fabric for the seat and back is specified separate from the back screen, if selected. For a monochromatic look, specify the same fabric for both the seat and back, and back screen.

Tip: The COM yards and COL square footage listed on these pages reflect the requirements for a single fabric that are based on non-directional 54"W material applied rail-roaded. For multi-fabric COM requirements, please refer to Multi-Fabric Yardage.
▶ Page 95

Tip: When specifying fabric in different price groups, the highest price group prevails.

Tip: Fabrics and leathers will appear loose with comfort wrinkles when upholstered.

Tip: 30"W corner sections are available with two seat fabric direction options – rail-roaded or cut-right. Illustrations assume a striped patterned fabric.
▶ Page 96

Standard Includes		Required to Specify	
▶ Need help? Product details, page 72	<ul style="list-style-type: none"> • Seat, back, and arms, if selected: fabric or leather • Legs: paint • Adjustable glides: paint to match legs • Back screen, if selected: fabric • Leveling wrench 	<ol style="list-style-type: none"> 1 Style number 2 Number of fabrics if contrasting fabric style number is selected 3 Fabric or leather color number for seat, back, and arms, if selected 4 Paint color number for legs and glides 5 Fabric color number for back screen, if selected 6 Options, if selected (see below) 	▶ See <i>Coalesse Surface Materials Reference Guide</i> .
Options		U.S. Price	Required to Specify
Surface Materials	<ul style="list-style-type: none"> • Contrasting fabric 	+\$113 per fabric	Add suffix K to the style number and select fabric color number.
	Fire code seating		
	• CAL 133 for 30"W sections	+\$437	Specify with CAL 133.
	• CAL 133 for 48"W, 54"W, and 72"W sections	+\$568	Specify with CAL 133.
	• CAL 133 for 72"W sections with back screen	+\$681	Specify with CAL 133. ▶ See <i>Coalesse Surface Materials Reference Guide</i> .
	Acrylic backer		
	• Backer for 30"W sections	+\$ 44	Specify with acrylic backer.
	• Backer for 30"W sections with back screen	+\$ 64	Specify with acrylic backer.
	• Backer for 48"W sections	+\$ 52	Specify with acrylic backer.
	• Backer for 48"W sections with back screen	+\$ 79	Specify with acrylic backer.
	• Backer for 54"W sections	+\$ 79	Specify with acrylic backer.
	• Backer for 72"W sections	+\$ 69	Specify with acrylic backer.
	• Backer for 54"W and 72"W sections with back screen	+\$ 120	Specify with acrylic backer. ▶ See <i>Coalesse Surface Materials Reference Guide</i> .
Seat Height	• 18" seat height	+\$212	Specify with 18" seat height.
Related Products	<ul style="list-style-type: none"> • Bench • Podium • Bridge tables • Occasional tables • Work booth tables • Side tables 		<ul style="list-style-type: none"> ▶ Page 90 ▶ Page 92 ▶ Page 98 ▶ Page 100 ▶ Page 101 ▶ Page 102

Specification Information

Style Number	U.S. Base Prices												Leather Grades:			
	Fabric Grades:												COL	C	E	
	COM	6	7	8	9	10	11	12	13	14						

30"W Corner Section–Left Section with Seat Fabric Rail-roaded

BSC30LA	\$2175	\$2332	\$2398	\$2447	\$2574	\$2644	\$2701	\$2828	\$2886	\$3150	\$2467	\$3457	\$3652
---------	--------	--------	--------	--------	--------	--------	--------	--------	--------	--------	--------	--------	--------

COM/yds = 4½, COL/sq ft = 90

30"W Corner Section–Left Section with Seat Fabric Cut-Right

BSC30LB	\$2175	\$2332	\$2398	\$2447	\$2574	\$2644	\$2701	\$2828	\$2886	\$3150	\$2467	\$3457	\$3652
---------	--------	--------	--------	--------	--------	--------	--------	--------	--------	--------	--------	--------	--------

COM/yds = 4½, COL/sq ft = 90

▶ Specification Information, continued on next page

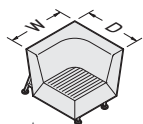
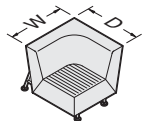

For Canadian Pricing
Multiply U.S. Price by the Canadian price factor.
▶ See page 1 for details.

Bix Sectional Seating

DESIGN METRO DESIGN GROUP

 = Available in Rapid10.

► Specification Information, continued from previous page

Specification Information

Style Number	U.S. Base Prices														Leather Grades:		
	Fabric Grades:														COL	C	E
	COM	6	7	8	9	10	11	12	13	14							

30"W Corner Section–Right Section with Seat Fabric Railroaded

BSC30RA	\$2175	\$2332	\$2398	\$2447	\$2574	\$2644	\$2701	\$2828	\$2886	\$3150	\$2467	\$3457	\$3652
COM/yds = 4½, COL/sq ft = 90													

30"W Corner Section–Right Section with Seat Fabric Cut-Right

BSC30RB	\$2175	\$2332	\$2398	\$2447	\$2574	\$2644	\$2701	\$2828	\$2886	\$3150	\$2467	\$3457	\$3652
COM/yds = 4½, COL/sq ft = 90													

30"W Corner Section with Back Screen–Left Section with Seat Fabric Railroaded

BSCB30LA	\$2884	\$3128	\$3222	\$3296	\$3477	\$3578	\$3661	\$3844	\$3927	\$4310	\$3275	\$4902	\$5227
Chair: COM/yds = 4½, COL/sq ft = 90 Screen: COM/yds = 2													

30"W Corner Section with Back Screen–Left Section with Seat Fabric Cut-Right

BSCB30LB	\$2884	\$3128	\$3222	\$3296	\$3477	\$3578	\$3661	\$3844	\$3927	\$4310	\$3275	\$4902	\$5227
Chair: COM/yds = 4½, COL/sq ft = 90 Screen: COM/yds = 2													

30"W Corner Section with Back Screen–Right Section with Seat Fabric Railroaded

BSCB30RA	\$2884	\$3128	\$3222	\$3296	\$3477	\$3578	\$3661	\$3844	\$3927	\$4310	\$3275	\$4902	\$5227
Chair: COM/yds = 4½, COL/sq ft = 90 Screen: COM/yds = 2													

30"W Corner Section with Back Screen–Right Section with Seat Fabric Cut-Right

BSCB30RB	\$2884	\$3128	\$3222	\$3296	\$3477	\$3578	\$3661	\$3844	\$3927	\$4310	\$3275	\$4902	\$5227
Chair: COM/yds = 4½, COL/sq ft = 90 Screen: COM/yds = 2													

► Specification Information, continued on next page

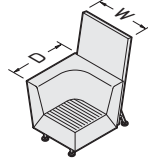
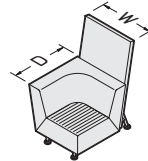
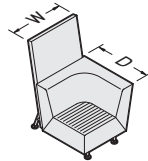
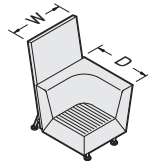
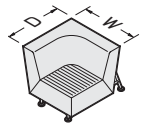
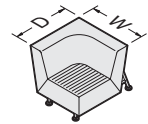

For Canadian Pricing
Multiply U.S. Price by the
Canadian price factor.
► See page 1 for details.

Bix Sectional Seating *continued*

DESIGN METRO DESIGN GROUP

 = Available in Rapid10.

Tip: Extended corner sections are standard with a railroaded seat and back fabric direction.
▶ Page 96

Tip: Fabrics and leathers will appear loose with comfort wrinkles when upholstered.

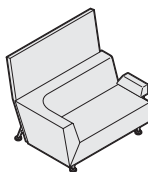
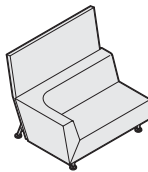
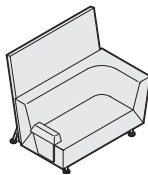
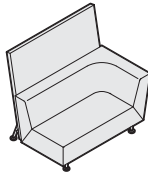
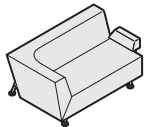
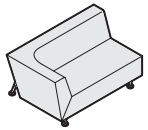
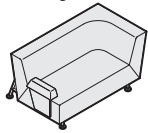
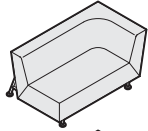

► Specification Information, continued from previous page

Specification Information

Style Number	U.S. Base Prices														Leather Grades:		
	Fabric Grades:														COL	C	E
	COM	6	7	8	9	10	11	12	13	14							

54"W Extended Corner Section–Left Section

BSE54LX	\$3020	\$3286	\$3388	\$3465	\$3662	\$3770	\$3859	\$4057	\$4146	\$4558	\$3431	\$4854	\$5146
---------	--------	--------	--------	--------	--------	--------	--------	--------	--------	--------	--------	--------	--------

COM/yds = 7, COL/sq ft = 140

54"W Extended Corner Section–Left Section with Arm

BSE54LA	\$3322	\$3609	\$3719	\$3802	\$4013	\$4130	\$4224	\$4436	\$4531	\$4972	\$3773	\$5340	\$5665
---------	--------	--------	--------	--------	--------	--------	--------	--------	--------	--------	--------	--------	--------

COM/yds = 7½, COL/sq ft = 149

54"W Extended Corner Section–Right Section

BSE54RX	\$3020	\$3286	\$3388	\$3465	\$3662	\$3770	\$3859	\$4057	\$4146	\$4558	\$3431	\$4854	\$5146
---------	--------	--------	--------	--------	--------	--------	--------	--------	--------	--------	--------	--------	--------

COM/yds = 7, COL/sq ft = 140

54"W Extended Corner Section–Right Section with Arm

BSE54RA	\$3322	\$3609	\$3719	\$3802	\$4013	\$4130	\$4224	\$4436	\$4531	\$4972	\$3773	\$5340	\$5665
---------	--------	--------	--------	--------	--------	--------	--------	--------	--------	--------	--------	--------	--------

COM/yds = 7½, COL/sq ft = 149

54"W Extended Corner Section–Left Section with Back Screen

BSEB54LX	\$3904	\$4344	\$4504	\$4626	\$4936	\$5106	\$5245	\$5553	\$5696	\$6345	\$4435	\$6933	\$7437
----------	--------	--------	--------	--------	--------	--------	--------	--------	--------	--------	--------	--------	--------

Chair: COM/yds = 7, COL/sq ft = 140
Screen: COM/yds = 4

54"W Extended Corner Section–Left Section with Back Screen and Arm

BSEB54LA	\$4204	\$4666	\$4833	\$4960	\$5283	\$5462	\$5607	\$5931	\$6080	\$6757	\$4774	\$7601	\$8170
----------	--------	--------	--------	--------	--------	--------	--------	--------	--------	--------	--------	--------	--------

Chair: COM/yds = 7½, COL/sq ft = 149
Screen: COM/yds = 4

54"W Extended Corner Section–Right Section with Back Screen

BSEB54RX	\$3904	\$4344	\$4504	\$4626	\$4936	\$5106	\$5245	\$5553	\$5696	\$6345	\$4435	\$6933	\$7437
----------	--------	--------	--------	--------	--------	--------	--------	--------	--------	--------	--------	--------	--------

Chair: COM/yds = 7, COL/sq ft = 140
Screen: COM/yds = 4

54"W Extended Corner Section–Right Section with Back Screen and Arm

BSEB54RA	\$4204	\$4666	\$4833	\$4960	\$5283	\$5462	\$5607	\$5931	\$6080	\$6757	\$4774	\$7601	\$8170
----------	--------	--------	--------	--------	--------	--------	--------	--------	--------	--------	--------	--------	--------

Chair: COM/yds = 7½, COL/sq ft = 149
Screen: COM/yds = 4

► Specification Information, continued on next page

Bix Sectional Seating

DESIGN METRO DESIGN GROUP

 = Available in Rapid10.

Tip: Straight sections are standard with a railroaded seat and back fabric direction.

► Page 96

► Specification Information, continued from previous page

Specification Information

Style Number	U.S. Base Prices											Leather Grades:		
	Fabric Grades:											COL	C	E
	COM	6	7	8	9	10	11	12	13	14				

48"W Straight Section

BSS48XX	\$2250	\$2407	\$2473	\$2522	\$2649	\$2719	\$2776	\$2903	\$2961	\$3225	\$2554	\$3808	\$4051
----------------	--------	--------	--------	--------	--------	--------	--------	--------	--------	--------	--------	--------	--------

COM/yds = 4½, COL/sq ft = 90

48"W Straight Section with Left Arm

BSS48AX	\$2551	\$2729	\$2803	\$2859	\$2999	\$3077	\$3139	\$3280	\$3344	\$3639	\$2896	\$4200	\$4460
----------------	--------	--------	--------	--------	--------	--------	--------	--------	--------	--------	--------	--------	--------

COM/yds = 5, COL/sq ft = 99

48"W Straight Section with Right Arm

BSS48XA	\$2551	\$2729	\$2803	\$2859	\$2999	\$3077	\$3139	\$3280	\$3344	\$3639	\$2896	\$4200	\$4460
----------------	--------	--------	--------	--------	--------	--------	--------	--------	--------	--------	--------	--------	--------

COM/yds = 5, COL/sq ft = 99

48"W Straight Section with Two Arms

BSS48AA	\$2851	\$3053	\$3131	\$3192	\$3347	\$3433	\$3502	\$3657	\$3728	\$4051	\$3236	\$4685	\$4977
----------------	--------	--------	--------	--------	--------	--------	--------	--------	--------	--------	--------	--------	--------

COM/yds = 5½, COL/sq ft = 108

48"W Straight Section with Back Screen

 BSSB48XX	\$3069	\$3356	\$3466	\$3549	\$3760	\$3877	\$3971	\$4183	\$4278	\$4719	\$3487	\$5731	\$6169
---	--------	--------	--------	--------	--------	--------	--------	--------	--------	--------	--------	--------	--------

Chair: COM/yds = 4½, COL/sq ft = 90
Screen: COM/yds = 3

48"W Straight Section with Back Screen and Left Arm

BSSB48AX	\$3370	\$3680	\$3796	\$3885	\$4110	\$4234	\$4335	\$4560	\$4663	\$5134	\$3828	\$6124	\$6578
-----------------	--------	--------	--------	--------	--------	--------	--------	--------	--------	--------	--------	--------	--------

Chair: COM/yds = 5, COL/sq ft = 99
Screen: COM/yds = 3

48"W Straight Section with Back Screen and Right Arm

BSSB48XA	\$3370	\$3680	\$3796	\$3885	\$4110	\$4234	\$4335	\$4560	\$4663	\$5134	\$3828	\$6124	\$6578
-----------------	--------	--------	--------	--------	--------	--------	--------	--------	--------	--------	--------	--------	--------

Chair: COM/yds = 5, COL/sq ft = 99
Screen: COM/yds = 3

► Specification Information, continued on next page

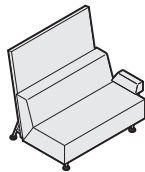
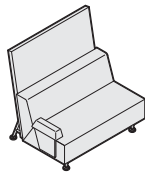
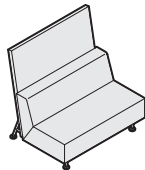
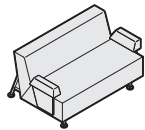
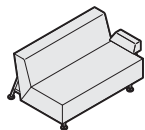
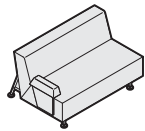
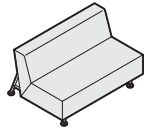

For Canadian Pricing
Multiply U.S. Price by the Canadian price factor.
► See page 1 for details.

Bix Sectional Seating *continued*

DESIGN METRO DESIGN GROUP

 = Available in Rapid10.

Tip: Straight sections are standard with a railroaded seat and back fabric direction.

► Page 96

Tip: Fabrics and leathers will appear loose with comfort wrinkles when upholstered.

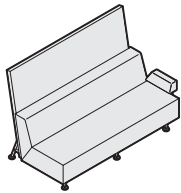
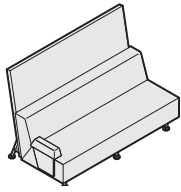
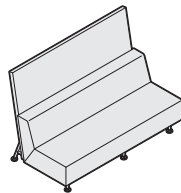
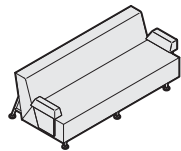
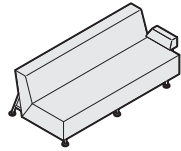
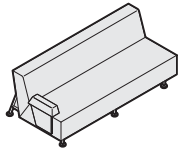
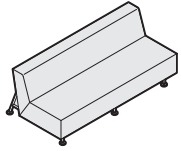

► Specification Information, continued from previous page

Specification Information

Style Number	U.S. Base Prices														Leather Grades:		
	Fabric Grades:														COL	C	E
	COM	6	7	8	9	10	11	12	13	14							

72"W Straight Section

BSS72XX	\$3179	\$3423	\$3517	\$3591	\$3772	\$3873	\$3956	\$4139	\$4222	\$4605	\$3610	\$5197	\$5522
----------------	--------	--------	--------	--------	--------	--------	--------	--------	--------	--------	--------	--------	--------

COM/yds = 6½, COL/sq ft = 130

72"W Straight Section with Left Arm

BSS72AX	\$3478	\$3744	\$3846	\$3923	\$4120	\$4228	\$4317	\$4515	\$4604	\$5016	\$3953	\$5680	\$6037
----------------	--------	--------	--------	--------	--------	--------	--------	--------	--------	--------	--------	--------	--------

COM/yds = 7, COL/sq ft = 139

72"W Straight Section with Right Arm

BSS72XA	\$3478	\$3744	\$3846	\$3923	\$4120	\$4228	\$4317	\$4515	\$4604	\$5016	\$3953	\$5680	\$6037
----------------	--------	--------	--------	--------	--------	--------	--------	--------	--------	--------	--------	--------	--------

COM/yds = 7, COL/sq ft = 139

72"W Straight Section with Two Arms

BSS72AA	\$3780	\$4067	\$4177	\$4260	\$4471	\$4588	\$4682	\$4894	\$4989	\$5430	\$4293	\$6167	\$6555
----------------	--------	--------	--------	--------	--------	--------	--------	--------	--------	--------	--------	--------	--------

COM/yds = 7½, COL/sq ft = 148

72"W Straight Section with Back Screen



BSSB72XX	\$4273	\$4713	\$4873	\$4995	\$5305	\$5475	\$5614	\$5922	\$6065	\$6714	\$4854	\$7946	\$8563
-----------------	--------	--------	--------	--------	--------	--------	--------	--------	--------	--------	--------	--------	--------

Chair: COM/yds = 6½, COL/sq ft = 130
Screen: COM/yds = 4½

72"W Straight Section with Back Screen and Left Arm

BSSB72AX	\$4571	\$5033	\$5200	\$5327	\$5650	\$5829	\$5974	\$6298	\$6447	\$7124	\$5193	\$8428	\$9077
-----------------	--------	--------	--------	--------	--------	--------	--------	--------	--------	--------	--------	--------	--------

Chair: COM/yds = 7, COL/sq ft = 139
Screen: COM/yds = 4½

72"W Straight Section with Back Screen and Right Arm

BSSB72XA	\$4571	\$5033	\$5200	\$5327	\$5650	\$5829	\$5974	\$6298	\$6447	\$7124	\$5193	\$8428	\$9077
-----------------	--------	--------	--------	--------	--------	--------	--------	--------	--------	--------	--------	--------	--------

Chair: COM/yds = 7, COL/sq ft = 139
Screen: COM/yds = 4½

Bix Multi-Fabric Diagram and Yardage Request Form

DESIGN METRO DESIGN GROUP

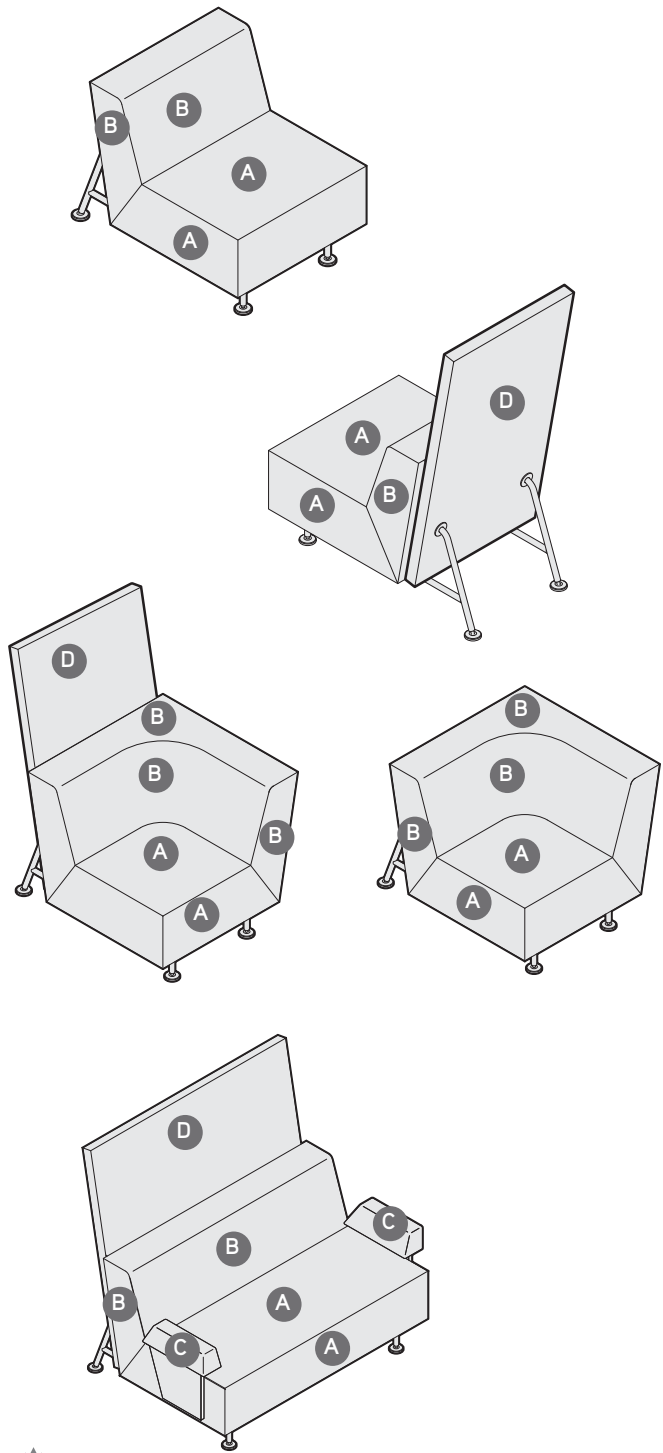

TO: _____

FROM: _____

DATE: _____

FAX...888.413.5161

Lounge Seating

A Seat (upholstery selections default for entire unit if B is not selected): _____

B Back: _____

C Arms (if applicable): _____

D Backscreen (if applicable): _____

**Back screen defined separately when ordered.*

** \$113 U.S. list per contrasting fabric specified. List price based on highest fabric grade usage.*

 **For Canadian Pricing**
 Multiply U.S. Price by the
 Canadian price factor.
 ▶ See page 1 for details.

Bix Benches

DESIGN METRO DESIGN GROUP

Tip: Fabrics and leathers will appear loose with comfort wrinkles when upholstered.

Tip: The COM yards and COL square footage listed on this page reflect the requirements for a single fabric that are based on non-directional 54"W material applied railroaded.

Standard Includes		Required to Specify	
<ul style="list-style-type: none"> Need help? Product details, page 72 	<ul style="list-style-type: none"> Seat: fabric or leather Legs and open storage interior, if selected: paint Adjustable glides: paint to match legs Leveling wrench 	<ol style="list-style-type: none"> Style number Fabric or leather color number for seat Paint color number for legs, glides, and open storage interior, if selected Options, if selected (see below) 	<p>▶ See <i>Coalesse Surface Materials Reference Guide</i>.</p>
Options		U.S. Price	Required to Specify
Surface Materials	Fire code seating		
	<ul style="list-style-type: none"> CAL 133 for 48"W benches +\$437 CAL 133 for 72"W benches +\$568 		Specify with CAL 133. Specify with CAL 133. ▶ See <i>Coalesse Surface Materials Reference Guide</i> .
	Acrylic backer		
	<ul style="list-style-type: none"> Backer for 48"W benches +\$ 21 Backer for 72"W benches +\$ 27 		Specify with acrylic backer. Specify with acrylic backer. ▶ See <i>Coalesse Surface Materials Reference Guide</i> .
Seat Height	<ul style="list-style-type: none"> 18" seat height +\$212 		Specify with 18" seat height.
Related Products	<ul style="list-style-type: none"> Lounge chairs Sectional seating Podium Side tables 		▶ Page 82 ▶ Page 84 ▶ Page 92 ▶ Page 102

Specification Information

Style Number	U.S. Base Prices												Leather Grades:			
	Fabric Grades:												COL	C	E	
	COM	6	7	8	9	10	11	12	13	14						

48"W Bench

BB48	\$1391	\$1451	\$1484	\$1509	\$1571	\$1606	\$1635	\$1699	\$1727	\$1860	\$1575	\$2397	\$2543
-------------	--------	--------	--------	--------	--------	--------	--------	--------	--------	--------	--------	--------	--------

COM/yds = 2¼, COL/sq ft = 41

72"W Bench

BB72	\$1664	\$1757	\$1798	\$1833	\$1918	\$1963	\$2001	\$2086	\$2125	\$2302	\$1888	\$2946	\$3141
-------------	--------	--------	--------	--------	--------	--------	--------	--------	--------	--------	--------	--------	--------

COM/yds = 3, COL/sq ft = 54

48"W Bench with Open Storage

BBS48	\$1609	\$1669	\$1702	\$1727	\$1789	\$1824	\$1853	\$1917	\$1945	\$2078	\$1823	\$2615	\$2761
--------------	--------	--------	--------	--------	--------	--------	--------	--------	--------	--------	--------	--------	--------

COM/yds = 2¼, COL/sq ft = 41

72"W Bench with Open Storage

BBS72	\$1883	\$1976	\$2017	\$2052	\$2137	\$2182	\$2220	\$2305	\$2344	\$2521	\$2136	\$3165	\$3360
--------------	--------	--------	--------	--------	--------	--------	--------	--------	--------	--------	--------	--------	--------

COM/yds = 3, COL/sq ft = 54

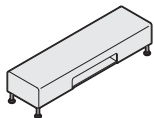
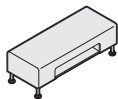
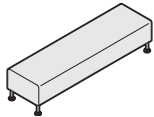
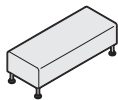

For Canadian Pricing
 Multiply U.S. Price by the Canadian price factor.
 ▶ See page 1 for details.

Coalesse

Bix Benches

DESIGN METRO DESIGN GROUP

Bix Podium

DESIGN METRO DESIGN GROUP

Tip: The COM yards and COL square footage listed on this page reflect the requirements for a single fabric that are based on non-directional 54"W material applied rail-roaded. For multi-fabric COM requirements, please refer to Multi-Fabric Yardage and Square Footage Requirements.
▶ Page 95

Tip: When specifying fabric in different price groups, the highest price group prevails.

Tip: Wood veneer storage drawers are available in high sheen finishes only.

Standard Includes		Required to Specify	
▶ Need help? Product details, page 72	<ul style="list-style-type: none"> • Seat and bolster: fabric or leather • Legs, tablet support, drawer pull, and projection screen frame, if selected: paint • Tablet surface: dark gray vinyl only • Drawer front: laminate • Face-mounted lock, keyed random: black only • Projection screen, if selected: sand color mesh • Adjustable glides: paint to match legs • Leveling wrench 	<ol style="list-style-type: none"> 1 Style number 2 Number of fabrics if contrasting fabric style number is selected 3 Fabric or leather color number for seat and bolster 4 Paint color number for legs, glides, tablet support, drawer pull, and projection screen frame, if selected 5 Laminate color number for drawer front 6 Options, if selected (see below) 	▶ See <i>Coalesse Surface Materials Reference Guide</i> .
Options		U.S. Price	Required to Specify
Surface Materials	<ul style="list-style-type: none"> • Contrasting fabric 	+\$113 per fabric	Add suffix K to the style number and select fabric color number.
	Fire code seating		
	<ul style="list-style-type: none"> • CAL 133 	+\$568	Specify with CAL 133. ▶ See <i>Coalesse Surface Materials Reference Guide</i> .
	Acrylic backer		
	<ul style="list-style-type: none"> • Backer 	+\$ 60	Specify with acrylic backer. ▶ See <i>Coalesse Surface Materials Reference Guide</i> .
	Storage drawer		
	<ul style="list-style-type: none"> • Wood veneer Grade 1 • Wood veneer Grade 2 	+\$ 30 +\$ 49	Specify with wood drawer front and select wood veneer grade 1 color number. Specify with wood drawer front and select wood veneer grade 2 color number.
	Grade 2 laminate drawer front	No cost	Specify laminate color number.
	Wood		
	<ul style="list-style-type: none"> • Custom wood finish 		▶ See <i>Coalesse Surface Materials Reference Guide</i> .
Seat Height	<ul style="list-style-type: none"> • 18" seat height 	+\$212	Specify with 18" seat height.
Related Products	<ul style="list-style-type: none"> • Lounge chairs • Sectional seating • Bench • Side tables 		▶ Page 82 ▶ Page 84 ▶ Page 90 ▶ Page 102

Specification Information

Style Number	U.S. Base Prices														Leather Grades:		
	Fabric Grades:														COL	C	E
	COM	6	7	8	9	10	11	12	13	14							

Podium with Left Tablet

BP72TX	\$3699	\$3922	\$4009	\$4075	\$4244	\$4337	\$4413	\$4582	\$4660	\$5013	\$4205	\$6086	\$6474
--------	--------	--------	--------	--------	--------	--------	--------	--------	--------	--------	--------	--------	--------

COM/yds = 6, COL/sq ft = 108

▶ Specification Information, continued on next page

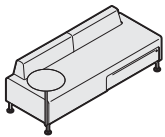

For Canadian Pricing
Multiply U.S. Price by the Canadian price factor.
▶ See page 1 for details.

► Specification Information, continued from previous page

Specification Information

Style Number	U.S. Base Prices														Leather Grades:		
	Fabric Grades:														COL	C	E
	COM	6	7	8	9	10	11	12	13	14							

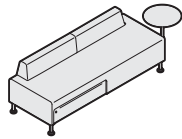

Podium with Right Tablet

BP72XT	\$3699	\$3922	\$4009	\$4075	\$4244	\$4337	\$4413	\$4582	\$4660	\$5013	\$4205	\$6086	\$6474
---------------	--------	--------	--------	--------	--------	--------	--------	--------	--------	--------	--------	--------	--------

COM/yds = 6, COL/sq ft = 108

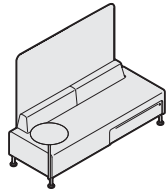

Podium with Projection Screen and Left Tablet

BPP72TX	\$4516	\$4739	\$4826	\$4892	\$5061	\$5154	\$5230	\$5399	\$5477	\$5830	\$5135	\$6903	\$7291
----------------	--------	--------	--------	--------	--------	--------	--------	--------	--------	--------	--------	--------	--------

COM/yds = 6, COL/sq ft = 108

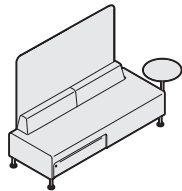

Podium with Projection Screen and Right Tablet

BPP72XT	\$4516	\$4739	\$4826	\$4892	\$5061	\$5154	\$5230	\$5399	\$5477	\$5830	\$5135	\$6903	\$7291
----------------	--------	--------	--------	--------	--------	--------	--------	--------	--------	--------	--------	--------	--------

COM/yds = 6, COL/sq ft = 108

 **For Canadian Pricing**
 Multiply U.S. Price by the
 Canadian price factor.
 ► See page 1 for details.

Bix Multi-Fabric Diagram and Yardage Request Form

DESIGN METRO DESIGN GROUP

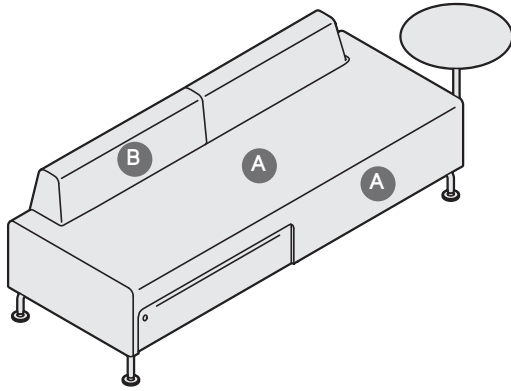

TO: _____

FROM: _____

DATE: _____

FAX...888.413.5161

A Seat (upholstery selections default for entire unit if B is not selected): _____

B Back: _____

** \$113 U.S. list per contrasting fabric specified. List price based on highest fabric grade usage.*



For Canadian Pricing
Multiply U.S. Price by the
Canadian price factor.
▶ See page 1 for details.

Multi-Fabric Yardage

Description	Style Number	COM Yds*			
		Seat	Back	Arm(s)	Back Screen
Lounge chair	BL26XX	1¾	1¾	N.A.	N.A.
Lounge chair with arms	BL26AA	1¾	1¾	1	N.A.
Lounge chair with back screen	BLB26XX	1¾	1¾	N.A.	1¾
Sled lounge chair	BLD26XX	1¾	1¾	N.A.	N.A.
Sled lounge chair with arms	BLD26AA	1¾	1¾	1	N.A.
Sled lounge chair with left-hand tablet arm	BLD26TX	1¾	1¾	N.A.	N.A.
Sled lounge chair with right-hand tablet arm	BLD26XT	1¾	1¾	N.A.	N.A.
30"W corner section-left section with seat fabric railroaded	BSC30LA	2	2½	N.A.	N.A.
30"W corner section-left section with seat fabric cut-right	BSC30LB	2	2½	N.A.	N.A.
30"W corner section-right section with seat fabric railroaded	BSC30RA	2	2½	N.A.	N.A.
30"W corner section-right section with seat fabric cut-right	BSC30RB	2	2½	N.A.	N.A.
30"W corner section with back screen-left section with seat fabric railroaded	BSCB30LA	2	2½	N.A.	2
30"W corner section with back screen-left section with seat fabric cut-right	BSCB30LB	2	2½	N.A.	2
30"W corner section with back screen-right section with seat fabric railroaded	BSCB30RA	2	2½	N.A.	2
30"W corner section with back screen-right section with seat fabric cut-right	BSCB30RB	2	2½	N.A.	2
54"W extended corner section-left section	BSE54LX	2½	3	N.A.	N.A.
54"W extended corner section-left section with arm	BSE54LA	2½	3	½	N.A.
54"W extended corner section-right section	BSE54RX	2½	3	N.A.	N.A.
54"W extended corner section-right section with arm	BSE54RA	2½	3	½	N.A.
54"W extended corner section-left section with back screen	BSEB54LX	2½	3	N.A.	4
54"W extended corner section-left section with back screen and arm	BSEB54LA	2½	3	½	4
54"W extended corner section-right section with back screen	BSEB54RX	2½	3	N.A.	4
54"W extended corner section-right section with back screen and arm	BSEB54RA	2½	3	½	4
48"W straight section	BSS48XX	2½	2½	N.A.	N.A.
48"W straight section with left arm	BSS48AX	2½	2½	½	N.A.
48"W straight section with right arm	BSS48XA	2½	2½	½	N.A.
48"W straight section with two arms	BSS48AA	2½	2½	1	N.A.
48"W straight section with back screen	BSSB48XX	2½	2½	N.A.	3
48"W straight section with back screen and left arm	BSSB48AX	2½	2½	½	3
48"W straight section with back screen and right arm	BSSB48XA	2½	2½	½	3
72"W straight section	BSS72XX	4½	4½	N.A.	N.A.
72"W straight section with left arm	BSS72AX	4½	4½	½	N.A.
72"W straight section with right arm	BSS72XA	4½	4½	½	N.A.
72"W straight section with two arms	BSS72AA	4½	4½	1	N.A.
72"W straight section with back screen	BSSB72XX	4½	4½	N.A.	4½
72"W straight section with back screen and left arm	BSSB72AX	4½	4½	½	4½
72"W straight section with back screen and right arm	BSSB72XA	4½	4½	½	4½

*Fabric yardage is based on non-directional/solid fabrics. use conversion chart on the following page for repeat/printed fabric yardage.

Multi-Fabric Yardage

DESCRIPTION	STYLE NUMBER	COM YDS*			
		SEAT CUSHION	BACK CUSHION	ARM(S)	BACK SCREEN
Podium with left tablet	BP72TX	3½	2½	N.A.	N.A.
Podium with right tablet	BP72XT	3½	2½	N.A.	N.A.
Podium with projection screen and left tablet	BPP72TX	3½	2½	N.A.	N.A.
Podium with projection screen and right tablet	BPP72XT	3½	2½	N.A.	N.A.

*Fabric yardage is based on non-directional/solid fabrics. Use conversion chart below for repeat/printed fabric yardage.

Non-standard fabric requirements

Yardage requirements shown are based on non-directional 54"W material applied railroaded. Coalesse will apply fabric railroaded unless instructed otherwise on the dealer's purchase order. The following conversion chart should be used to determine yardage requirements when COM has a repeat of 2" or more. Please contact Coalesse customer service for a yardage quotation if the fabric is less than 54" wide, has a repeat of more than 24", or if the fabric must be cut-right.

CONVERSION CHART

PRODUCT	REPEAT		
	2" - 8"	9" - 14"	15" - 24"
Bix	15%	30%	75%

Yardage quotations will also be provided for order of 10 or more pieces.

Pattern matching on Bix

Due to Coalesse's high standards for pattern matching, we reserve the right to apply the following upcharges for extra labor incurred by a pattern or material that poses such challenges.

Customers will be informed if an upcharge will be applied to their order during the approval process. Should Coalesse receive an order without prior approval, it will be held as pending until the customer accepts such charges. The upcharge will be applied per item where applicable.

Cutting direction guidelines

Cutting direction is based on the fabric width and the way the fabric is cut from the roll and applied to Coalesse products. There are two cutting directions: railroaded or cut-right.

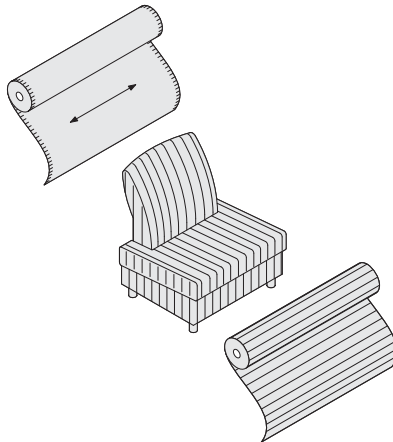

Horizontal or railroaded (across roll, warp horizontal) means fabric is cut across the roll; selvages are on the top and bottom.

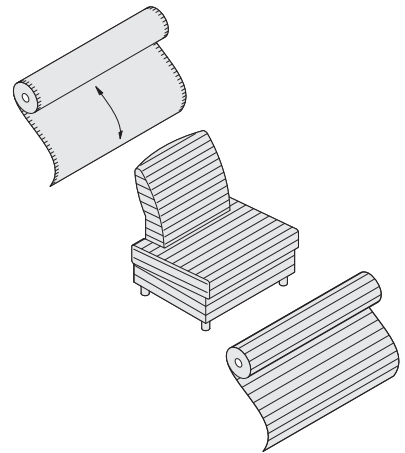

Vertical or cut-right (down roll, warp vertical) means fabric is cut in the same direction it is woven; selvages are on the left and right sides.

Coalesse reserves the right to railroad or apply fabric according to weave unless instructions specify otherwise. Fabrics are railroaded when possible to avoid seams in large upholstered areas and/or single cushion units. If a fabric is questionable, a cutting of adequate size showing full repeat (if any) should be sent to Coalesse for a fabric requirement quotation.

Bix Service Tray

DESIGN METRO DESIGN GROUP

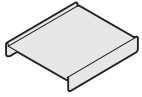

Standard Includes

- ▶ Need help?
Product details,
page 72
- Tray: paint

Required to Specify

- 1 Style number
- 2 Paint color number for tray
- ▶ See *Coalesse Surface Materials Reference Guide*.

Related Products

- Bench ▶ Page 90
- Podium ▶ Page 92

Specification Information

Dimensions			Style Number	U.S. Price
D	W	H		
20"	22"	4"	BATRAY	\$253

Lounge Seating



For Canadian Pricing
Multiply U.S. Price by the
Canadian price factor.
▶ See page 1 for details.

Standard Includes		Required to Specify
<p>► Need help? Product details, page 72</p>	<ul style="list-style-type: none"> • Top: <ul style="list-style-type: none"> - Laminate top (Grade 1 laminates) with matching plastic edge - Laminate top (Grade 1 Steelcase) with contrasting plastic edge - Wood top with matching flat wood edge • Frame, tilted display surface for rectangular tables, and support leg for corner tables, if selected: paint • Grommet, if selected: black plastic only • Screens, if selected: translucent material only • Wire management clips: black plastic only • Attachment hardware 	<p>1 Style number 2 Laminate or wood color number for top ► See <i>Coalesse Surface Materials Reference Guide</i>. 3 Plastic edge color number for top with Grade 1 Steelcase or Grade 2 laminate, if selected 4 Paint color number for frame, tilted display surface for rectangular tables, and support leg for corner tables, if selected 5 Options, if selected (see below) ► See <i>Coalesse Surface Materials Reference Guide</i>.</p>

Options	U.S. Price	Required to Specify
<p>Surface Materials</p> <ul style="list-style-type: none"> • Wood • Custom wood finish 		► See <i>Coalesse Surface Materials Reference Guide</i> .
<p>Cable Management</p> <ul style="list-style-type: none"> • PDV module: black plastic 	+\$347	Specify with <i>PDV module</i> .
<p>Corner Bridge Table Height</p> <ul style="list-style-type: none"> • 20" table height 	+\$212	Specify with <i>20" table height</i> .
<p>Related Products</p> <ul style="list-style-type: none"> • Sectional seating 		► Page 84

Tip: 20" table height must be used in conjunction with 18" seat height in the sectional seating.

Specification Information							
Dimensions			Style Number	U.S. Base Prices			
D	W	H		Lam 1	Lam 2	Wood 1	Wood 2

Rectangular Bridge Table

26"	22"	18"	BTB2226	\$829	\$872	\$1026	\$1132
-----	-----	-----	---------	-------	-------	--------	--------

Rectangular Bridge Table with Grommet

26"	22"	18"	BTB2226U	\$881	\$927	\$1078	\$1184
-----	-----	-----	----------	-------	-------	--------	--------

► Specification Information, continued on next page

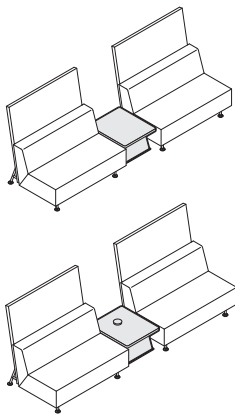

Edge Profiles

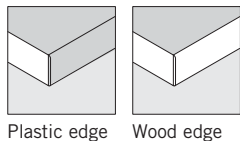

 **For Canadian Pricing**
Multiply U.S. Price by the Canadian price factor.
► See page 1 for details.

► Specification Information, continued from previous page

Specification Information

Dimensions			Style Number	U.S. Base Prices			
D	W	H		Lam 1	Lam 2	Wood 1	Wood 2

Rectangular Bridge Table with Screen

26"	22"	46"	BTBS2226	\$1252	\$1315	\$1449	\$1555
-----	-----	-----	----------	--------	--------	--------	--------

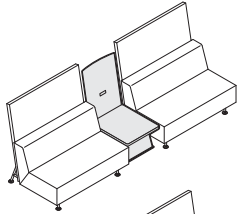

Rectangular Bridge Table with Grommet and Screen

26"	22"	46"	BTBS2226U	\$1305	\$1371	\$1502	\$1608
-----	-----	-----	-----------	--------	--------	--------	--------

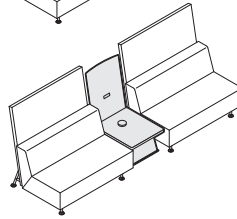

Corner Bridge Table

26"	26"	18"	BTB2626	\$ 939	\$ 987	\$1161	\$1267
-----	-----	-----	---------	--------	--------	--------	--------

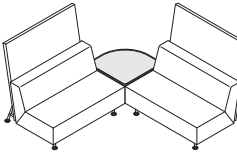

Corner Bridge Table with Grommet

26"	26"	18"	BTB2626U	\$ 991	\$1042	\$1213	\$1319
-----	-----	-----	----------	--------	--------	--------	--------

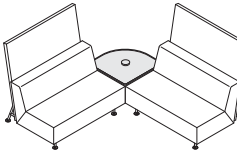

Corner Bridge Table with Screen

26"	26"	46"	BTBS2626	\$1492	\$1567	\$1714	\$1820
-----	-----	-----	----------	--------	--------	--------	--------

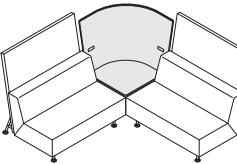

Corner Bridge Table with Grommet and Screen

26"	26"	46"	BTBS2626U	\$1544	\$1624	\$1766	\$1872
-----	-----	-----	-----------	--------	--------	--------	--------

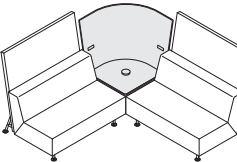

For Canadian Pricing
 Multiply U.S. Price by the
 Canadian price factor.
 ► See page 1 for details.

Bix 18"H Occasional Tables

DESIGN METRO DESIGN GROUP

Standard Includes		Required to Specify
<ul style="list-style-type: none"> ▶ Need help? Product details, page 72 	<ul style="list-style-type: none"> • Top: <ul style="list-style-type: none"> - Laminate top (Grade 1 laminates) with matching plastic edge - Laminate top (Grade 1 Steelcase) with contrasting plastic edge - Wood top with matching flat wood edge • Base: textured paints only • Grommet, if selected: black plastic only 	<ol style="list-style-type: none"> 1 Style number 2 Laminate or wood color number for top ▶ See <i>Coalesse Surface Materials Reference Guide</i>. 3 Plastic edge color number for top with Grade 1 Steelcase or Grade 2 laminate, if selected 4 Textured paint color number for base 5 Options, if selected (see below) ▶ See <i>Coalesse Surface Materials Reference Guide</i>.

Options	U.S. Price	Required to Specify
Surface Materials <ul style="list-style-type: none"> • Wood <ul style="list-style-type: none"> • Custom wood finish 		▶ See <i>Coalesse Surface Materials Reference Guide</i> .
Cable Management <ul style="list-style-type: none"> • PDV module: black plastic 	+\$347 each	Specify with PDV module.
Related Products <ul style="list-style-type: none"> • Lounge chair • Sectional seating 		▶ Page 82 ▶ Page 84

Tip: One or two power, data, and voice modules are available on rectangular occasional tables.

Specification Information

Dimensions				Style Number	U.S. Base Prices			
	D	W	H		Diameter	Lam 1	Lam 2	Wood 1

Round Occasional Tables

N.A.	N.A.	18"	20"	BTC20001	\$ 960	\$1009	\$1062	\$1111
N.A.	N.A.	18"	28"	BTC28001	\$1000	\$1051	\$1110	\$1216

Round Occasional Table with Grommet

N.A.	N.A.	18"	28"	BTC28001U	\$1065	\$1119	\$1175	\$1281
------	------	-----	-----	-----------	--------	--------	--------	--------

Square Occasional Table

24"	24"	18"	N.A.	BTC24241	\$ 986	\$1036	\$1094	\$1160
-----	-----	-----	------	----------	--------	--------	--------	--------

Square Occasional Table with Grommet

24"	24"	18"	N.A.	BTC24241U	\$1052	\$1106	\$1160	\$1226
-----	-----	-----	------	-----------	--------	--------	--------	--------

Rectangular Table

24"	48"	18"	N.A.	BTC24481	\$1595	\$1677	\$1763	\$1899
24"	72"	18"	N.A.	BTC24721	\$1635	\$1719	\$1822	\$2023

Rectangular Occasional Tables with Grommets

24"	48"	18"	N.A.	BTC24481U	\$1726	\$1814	\$1894	\$2030
24"	72"	18"	N.A.	BTC24721U	\$1766	\$1856	\$1953	\$2154

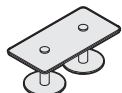
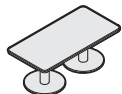

Edge Profiles

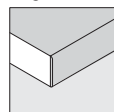

Plastic edge

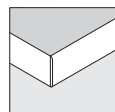

Wood edge

 **For Canadian Pricing**
Multiply U.S. Price by the Canadian price factor.
▶ See page 1 for details.

Bix 27"H Work-Booth Tables

DESIGN METRO DESIGN GROUP

 = Available in Rapid10.

Tip: One or two power, data, and voice modules are available on rectangular occasional tables.

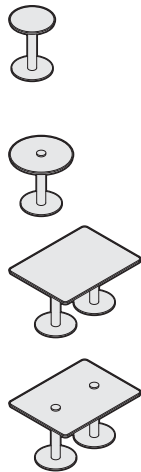

Standard Includes		Required to Specify
<ul style="list-style-type: none"> ▶ Need help? Product details, page 72 	<ul style="list-style-type: none"> • Top: <ul style="list-style-type: none"> - Laminate top (Grade 1 laminates) with matching plastic edge - Laminate top (Grade 1 Steelcase) with contrasting plastic edge - Wood top with matching flat wood edge • Base: textured paints only • Grommet, if selected: black plastic only 	<ol style="list-style-type: none"> 1 Style number 2 Laminate or wood color number for top <p>▶ See <i>Coalesse Surface Materials Reference Guide</i>.</p> <ol style="list-style-type: none"> 3 Plastic edge color number for top with Grade 1 Steelcase or Grade 2 laminate, if selected 4 Textured paint color number for base 5 Options, if selected (see below) <p>▶ See <i>Coalesse Surface Materials Reference Guide</i>.</p>

Options	U.S. Price	Required to Specify
Surface Materials <ul style="list-style-type: none"> • Wood <ul style="list-style-type: none"> • Custom wood finish 		▶ See <i>Coalesse Surface Materials Reference Guide</i> .
Cable Management <ul style="list-style-type: none"> • PDV module: black plastic 	+\$347 each	Specify with PDV module.
Related Products <ul style="list-style-type: none"> • Lounge chair • Sectional seating 		▶ Page 82 ▶ Page 84

Specification Information

Dimensions				Style Number	U.S. Base Prices			
	D	W	H		Diameter	Lam 1	Lam 2	Wood 1



Round Work-Booth Tables

N.A.	N.A.	27"	20"	BTW20003	\$ 986	\$1036	\$1088	\$1137
N.A.	N.A.	27"	28"	BTW28003	\$1026	\$1078	\$1136	\$1242

Round Work-Booth Table with Grommet

N.A.	N.A.	27"	28"	BTW28003U	\$1090	\$1145	\$1200	\$1306
------	------	-----	-----	-----------	--------	--------	--------	--------

Rectangular Work-Booth Tables

	36"	48"	27"	N.A.	BTW36483	\$1875	\$1971	\$2088	\$2290
	36"	72"	27"	N.A.	BTW36723	\$2075	\$2181	\$2288	\$2592

Rectangular Work-Booth Tables with Grommets

36"	48"	27"	N.A.	BTW36483U	\$2005	\$2107	\$2218	\$2420
36"	72"	27"	N.A.	BTW36723U	\$2205	\$2317	\$2418	\$2722

Edge Profiles

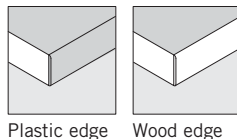

 **For Canadian Pricing**
 Multiply U.S. Price by the Canadian price factor.
 ▶ See page 1 for details.



Standard Includes		Required to Specify
▶ Need help? Product details, page 72	<ul style="list-style-type: none"> • Base: paint • Table surface and base cover: dark gray vinyl only 	1 Style number 2 Paint color number for base ▶ See <i>Coalesse Surface Materials Reference Guide</i> .

Related Products	
Lounge chairs	▶ Page 82
Sectional seating	▶ Page 84
Podium	▶ Page 92

Specification Information			
Dimensions		Style	U.S.
Diameter	H	Number	Price
17"	23"	BTS1700	\$478



For Canadian Pricing
 Multiply U.S. Price by the
 Canadian price factor.
 ▶ See page 1 for details.

Bob Chairs by Walter Knoll

DESIGN PEARSON LLOYD DESIGN ORIGIN: 2007 GERMANY

Tip: For Customer's Own Material or Leather, see necessary requirements, important processing instructions, and ordering information
 ▶ See *Coalesse Surface Materials Reference Guide*.

Tip: Fabrics and leathers will appear loose with comfort wrinkles when upholstered.

Standard Includes		Required to Specify	
	<ul style="list-style-type: none"> • Base: 8040 Aluminum Matte Polished • Upholstery for chair: fabric or leather • Glides 		<ol style="list-style-type: none"> 1 Style number 2 Number of fabrics if contrasting fabric style number is selected 3 Fabric or leather color number for upholstery 4 Options, if selected (see below) ▶ See <i>Coalesse Surface Materials Reference Guide</i> .
Options		U.S. Price	Required to Specify
Surface Materials	• Contrasting fabric	+\$113 per fabric	Add suffix K to the style number and select fabric color number.
	Fire code seating		
	• CAL 133	+\$218	Specify with CAL 133. ▶ See <i>Coalesse Surface Materials Reference Guide</i> .
	Acrylic backer		
	• Backer for lounge chair	+\$ 27	Specify with acrylic backer.
	• Backer for lounge chair with headrest	+\$ 31	Specify with acrylic backer.
	• Backer for ottoman	+\$ 10	Specify with acrylic backer. ▶ See <i>Coalesse Surface Materials Reference Guide</i> .
Glides	• Felted glides	+\$ 16	Specify with felted glides.

Specification Information														
Style Number	U.S. Base Prices												Leather Grades:	
	Fabric Grades:												COL	C
	COM	6	7	8	9	10	11	12	13	14				

Lounge Swivel Chair

216	\$2671	\$2718	\$2745	\$2764	\$2801	\$2835	\$2937	\$3004	\$3130	\$3284	\$2896	\$4124	\$4344
-----	--------	--------	--------	--------	--------	--------	--------	--------	--------	--------	--------	--------	--------

COM/yds = 3, COL/sq ft = 72



Overall: 34¼"D 35"W 31¾"H
 Inside: 21¾"D 20"W 17¼"H
 Seat: 17"H
 Arm: 21¾"H

Lounge Chair with Headrest

221	\$3160	\$3218	\$3251	\$3274	\$3319	\$3359	\$3476	\$3554	\$3700	\$3886	\$3385	\$4821	\$5079
-----	--------	--------	--------	--------	--------	--------	--------	--------	--------	--------	--------	--------	--------

COM/yds = 3½, COL/sq ft = 77



Overall: 34¼"D 35"W 41¼"H
 Inside: 21¾"D 20"W 27½"H
 Seat: 17"H
 Arm: 21¾"H

Ottoman

221-H	\$1003	\$ 994	\$1004	\$1010	\$1021	\$1031	\$1066	\$1088	\$1130	\$1190	\$1228	\$1612	\$1685
-------	--------	--------	--------	--------	--------	--------	--------	--------	--------	--------	--------	--------	--------

COM/yds = 1, COL/sq ft = 22



Overall: 18½"D 19¾"W 15¼"H



For Canadian Pricing
 Multiply U.S. Price by the Canadian price factor.
 ▶ See page 1 for details.

Coalesse

CH07 Shell Chair by Carl Hansen & Son

DESIGN HANS WEGNER DESIGN ORIGIN: DENMARK, 1963

 = Available in Rapid10.



Overall: 32½"D 36¼"W 26"H
Seat: 13¾"H

Tip: Not all finishes offered on every wood species, see matrix below.

Tip: For Customer's Own Material or Leather, see necessary requirements, important processing instructions, and ordering information

► See *Coalesse Surface Materials Reference Guide*.



Tip: Contact Coalesse Customer Service for a collection of curated upholstered shell chairs.

Standard Includes

- Upholstered seat and back cushion: fabric or leather
- Bent ply frame

Required to Specify

- 1 Style number
- 2 Fabric color number for upholstery, if selected
- 3 If Loke Leather is selected specify leather color number:
 - 5072 Loke 7210 Sand
 - 5073 Loke 7050 Light Antique
 - 5074 Loke 7270 Brown
 - 5075 Loke 7170 Red
 - 5076 Loke 7150 Black
 - 5077 Loke 7160 White
- 4 Wood species/finish number, (See matrix below)

Specification Information

Style Number	U.S. Prices			
	Fabric: COM	Group 2	Group 3	Leather: Loke Leather
CH07OAK	\$4316	\$4365	\$4388	\$4525
CH07ASH	\$3994	\$4043	\$4066	\$4203
CH07WALNUT	\$4670	\$4719	\$4742	\$4879
CH07BEECH	\$3994	\$4043	\$4066	\$4203

COM/yds = 1¼

Wood Species/Finish Number Matrix

Finish	Wood Species Number:			
	Oak	Ash	Walnut	Beech
Lacquer	3255	3615	3325	N.A.
White Oil	3265	3645	N.A.	N.A.
Oil	N.A.	N.A.	3335	N.A.
CHS Color	N.A.	N.A.	N.A.	3246



For Canadian Pricing
Multiply U.S. Price by the Canadian price factor.
► See page 1 for details.

Coalesse

CH25 Paddle Chair by Carl Hansen & Son

DESIGN HANS WEGNER DESIGN ORIGIN: DENMARK, 1950

 = Available in Rapid10.



Overall: 28¾"D 28"W 28¾"H
Seat: 15¼"H

Tip: Not all finishes offered on every wood species, see matrix below.

Tip: For Customer's Own Material or Leather, see necessary requirements, important processing instructions, and ordering information
▶ See Coalesse Surface Materials Reference Guide.

Standard Includes	Required to Specify
-------------------	---------------------

- Frame: wood
- Hand-woven papercord seat

- 1 Style number
- 2 Papercord: (See prices below)
 - Black: P500
 - Natural: P501
- 3 Wood species/finish number, (See matrix below)

Specification Information

Style Number	U.S. Prices	
	Papercord:	
	Natural	Black
 CH25OAK	\$5239	\$5891

Wood Species/Finish Number Matrix

Finish	Wood Species Number:
	Oak
Lacquer	3255
White Oil	3265

Lounge Seating



For Canadian Pricing
Multiply U.S. Price by the Canadian price factor.
▶ See page 1 for details.

CH44 Ladderback Chair by Carl Hansen & Son

DESIGN HANS WEGNER DESIGN ORIGIN: DENMARK, 1965



Overall: 26"D 25"W 31½"H
Seat: 15¼"H

Tip: Not all finishes offered on every wood species, see matrix below.

Tip: For Customer's Own Material or Leather, see necessary requirements, important processing instructions, and ordering information
▶ See Coalesse Surface Materials Reference Guide.

Standard Includes

- Frame: wood
- Hand-woven papercord seat

Required to Specify

- 1 Style number
- 2 Papercord: (See prices below)
 - Black: P500
 - Natural: P501
- 3 Wood species/finish number, (See matrix below)
- 4 Options, if selected (see below)

Options

Options	U.S. Price	Required to Specify
Cushion		
• Customer's own material (COM)	+\$ 723	Specify <i>with COM</i> and select fabric color number.
• Fabric group 2	+\$ 779	Specify <i>with cushion</i> and select color number.
• Fabric group 3	+\$ 795	Specify <i>with cushion</i> and select color number.
• Loke leather	+\$1358	Specify <i>with leather cushion</i> and select color number: - 5072 Loke 7210 Sand - 5073 Loke 7050 Light Antique - 5074 Loke 7270 Brown - 5075 Loke 7170 Red - 5076 Loke 7150 Black - 5077 Loke 7160 White

Specification Information

Style Number	U.S. Base Prices	
	Papercord:	
	Natural	Black
CH44OAK	\$2920	\$3106
CH44ASH	\$2864	\$3050

COM/yds = 1½

Wood Species/Finish Number Matrix

Finish	Wood Species Number:	
	Oak	Ash
Lacquer	3255	3615
White Oil	3265	3645



For Canadian Pricing
Multiply U.S. Price by the Canadian price factor.
▶ See page 1 for details.

CH100 Series by Carl Hansen & Son

DESIGN HANS WEGNER DESIGN ORIGIN: DENMARK, 1970

Tip: Thor leather used on CH100 products is not an exact color match to the Loke leather used on other Carl Hansen products.

Tip: For Customer's Own Material or Leather, see necessary requirements, important processing instructions, and ordering information
 ► See Coalesse Surface Materials Reference Guide.

Standard Includes

- Internal frame: wood
- Stainless steel external frame and hardware
- 9208 Chrome, etched finish
- Feather filled cushions

Required to Specify

- 1 Style number
 - 2 Fabric color number for upholstery, if selected
 - 3 If Thor leather is selected, specify leather color number:
 - 5394 Thor 300 Sand
 - 5395 Thor 307 Light Antique
 - 5396 Thor 306 Brown
 - 5397 Thor 339 Red
 - 5398 Thor 301 Black
 - 5399 Thor 390 White
- See Coalesse Surface Materials Reference Guide.

Specification Information

Style Number	U.S. Prices			Leather: Thor leather
	Fabric: COM	Group 2	Group 3	

100 Series Club Chair

CH101	\$ 9213	\$ 9325	\$ 9534	N.A.
CH101L	N.A.	N.A.	N.A.	\$12,040

COM/yds = 6½

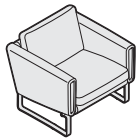

Overall: 30"D 30¾"W 28"H

100 Series Sofa

CH103	\$18,995	\$19,286	\$19,719	N.A.
CH103L	N.A.	N.A.	N.A.	\$26,615

COM/yds = 13

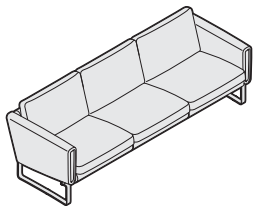

Overall: 30"D 85½"W 28"H
 Seat: 16½"H

 **For Canadian Pricing**
 Multiply U.S. Price by the Canadian price factor.
 ► See page 1 for details.

Coalesse

CH401 Airport Chair by Carl Hansen & Son

DESIGN HANS WEGNER DESIGN ORIGIN: DENMARK, 1958

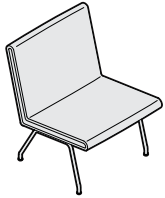

Overall: 27¹/₄"D 23¹/₂"W 29¹/₂"H
Seat: 17¹/₄"H

Tip: For Customer's Own Material or Leather, see necessary requirements, important processing instructions, and ordering information
▶ See *Coalesse Surface Materials Reference Guide*.

Standard Includes

- Chair: fabric or Loke Leather
- Frame: 9208 Chrome, etched finish

Required to Specify

- 1 Style number
 - 2 Fabric color number for upholstery, if selected
 - 3 If Loke Leather is selected specify leather color number:
 - 5072 Loke 7210 Sand
 - 5073 Loke 7050 Light Antique
 - 5074 Loke 7270 Brown
 - 5075 Loke 7170 Red
 - 5076 Loke 7150 Black
 - 5077 Loke 7160 White
- ▶ See *Coalesse Surface Materials Reference Guide*.

Specification Information

Style Number	U.S. Prices			Leather: Loke Leather
	Fabric: COM	Group 2	Group 3	
CH401	\$3397	\$3904	\$3968	\$4499

COM/yds = 2¹/₄



For Canadian Pricing
Multiply U.S. Price by the Canadian price factor.
▶ See page 1 for details.

Coalesse

CH445 Wing Chair by Carl Hansen & Son

DESIGN HANS WEGNER DESIGN ORIGIN: DENMARK, 1960

 = Available in Rapid10.

Tip: For Customer's Own Material or Leather, see necessary requirements, important processing instructions, and ordering information
 ▶ See *Coalesse Surface Materials Reference Guide*.

Standard Includes	Required to Specify
-------------------	---------------------

- Chair or ottoman: fabric or Loke Leather
- Internal Beech wood frame
- Legs: 9208 Chrome, etched finish

- 1 Style number
 - 2 Fabric color number for upholstery, if selected
 - 3 If Loke Leather is selected specify leather color number:
 - 5072 Loke 7210 Sand
 - 5073 Loke 7050 Light Antique
 - 5074 Loke 7270 Brown
 - 5075 Loke 7170 Red
 - 5076 Loke 7150 Black
 - 5077 Loke 7160 White
- ▶ See *Coalesse Surface Materials Reference Guide*.

Specification Information

Style Number	U.S. Prices			Leather: Loke Leather
	Fabric: COM	Group 2	Group 3	

Wing Chair

 CH445	\$7743	\$8201	\$8908	\$10,276
---	--------	--------	--------	----------

COM/yds = 9½



Overall: 38¼"D 35½"W 40½"H
 Seat: 15¾"H



Overall: 19¼"D 24½"W 14¾"H

Ottoman

CH446	\$2562	\$2739	\$2909	\$ 2876
-------	--------	--------	--------	---------

COM/yds = 1¾

For Canadian Pricing
 Multiply U.S. Price by the Canadian price factor.
 ▶ See page 1 for details.

Circa Modular Seating

DESIGN ALISON SPEAR, AIA DESIGN ORIGIN: UNITED STATES

 = Available in Rapid10.

Tip: These colors are different than other Coalesse powder coats.

Tip: Recommended leathers are Elmosoft Grade C and Elmorustical Grade E.

Tip: Special color match, consult customer service.

Tip: Fabrics and leathers will appear loose with comfort wrinkles when upholstered.

Tip: Pricing based on highest grade textile specified.

Tip: Contrasting option not available on benches.

Tip: Optional steel leg has 90° corner taper shape.

Tip: For Customer's Own Material or Leather, see necessary requirements, important processing instructions, and ordering information
 ▶ See *Coalesse Surface Materials Reference Guide*.

Standard Includes		Required to Specify	
	<ul style="list-style-type: none"> • Frame: unibody construction of hardwood plywood utilizing box joinery • Upholstery: multiple densities of polyurethane foam fixed seat and back with top stitch on seams • Legs: hardwood maple or walnut 		<ol style="list-style-type: none"> 1 Style number 2 Number of fabrics if contrasting fabric style number is selected 3 Fabric or leather color number for upholstery on seat and back 4 Wood color number for legs ▶ See <i>Coalesse Surface Materials Reference Guide</i> . 5 Options, if selected (see below) ▶ See <i>Coalesse Surface Materials Reference Guide</i> .
Surface Materials	Options	U.S. Price	Required to Specify
	<ul style="list-style-type: none"> • Contrasting Fabric 	+\$113 per fabric	Add suffix K to the style number and select fabric color number.
	Fire code seating <ul style="list-style-type: none"> • CAL 133 for 30° seats • CAL 133 for 60° loveseat and 60° bench • CAL 133 for straight loveseat and straight bench 	+\$218 +\$568 +\$437	Specify with CAL 133. Specify with CAL 133. Specify with CAL 133. ▶ See <i>Coalesse Surface Materials Reference Guide</i> .
	Acrylic backer <ul style="list-style-type: none"> • Backer for 30° outside facing wedge seat • Backer for 30° inside facing wedge seat • Backer for 60° outside and inside wedge loveseats • Backer for 60° benches • Backer for straight seat • Backer for straight loveseat • Backer for straight bench 	+\$ 29 +\$ 31 +\$ 56 +\$ 37 +\$ 21 +\$ 44 +\$ 27	Specify with acrylic backer. Specify with acrylic backer. Specify with acrylic backer. Specify with acrylic backer. Specify with acrylic backer. Specify with acrylic backer. Specify with acrylic backer. ▶ See <i>Coalesse Surface Materials Reference Guide</i> .
Metal Legs	<ul style="list-style-type: none"> • Powder coat steel legs 	+\$124 per leg	Specify with powder coat steel legs and specify color number: 4138 Graphite Gloss 4140 Arctic White Gloss 4142 Platinum Gloss 4144 Black Gloss 4148 Midnight Brown Gloss

Specification Information

Style Number	U.S. Base Prices														Leather Grades:		
	Fabric Grades:														COL	C	E
	COM	6	7	8	9	10	11	12	13	14							

30° Outside Facing Wedge Seat

451-3730FO	\$1226	\$1295	\$1330	\$1353	\$1401	\$1442	\$1573	\$1660	\$1739	\$1972	\$1492	\$3020	\$3298
------------	--------	--------	--------	--------	--------	--------	--------	--------	--------	--------	--------	--------	--------

COM/yds = 3¼, COL/sq ft = 72

▶ Specification Information, continued on next page

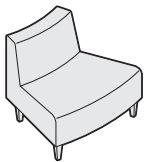

Overall: 28"D 36¾"W 29½"H
 Inside: 20"D 36¾"W 12¼"H
 Seat: 17¼"H
 Angle Degree: 30°

Circa Modular Seating

DESIGN ALISON SPEAR, AIA DESIGN ORIGIN: UNITED STATES

 = Available in Rapid10.

► Specification Information, continued from previous page

Specification Information

Style Number	U.S. Base Prices													
	Fabric Grades:											Leather Grades:		
	COM	6	7	8	9	10	11	12	13	14	COL	C	E	

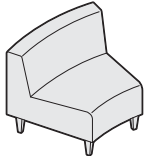

Overall: 28"D 36¾"W 29½"H
 Inside: 20"D 36¾"W 12¼"H
 Seat: 17¼"H
 Angle Degree: 30°

30° Inside Facing Wedge Seat

 451-3730FI	\$1226	\$1295	\$1330	\$1353	\$1401	\$1442	\$1573	\$1660	\$1739	\$1972	\$1492	\$3020	\$3298
---	--------	--------	--------	--------	--------	--------	--------	--------	--------	--------	--------	--------	--------

COM/yds = 3¼, COL/sq ft = 72

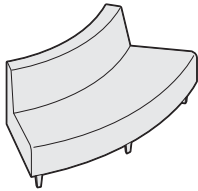

Overall: 28"D 71"W 29½"H
 Inside: 20"D 71"W 12¼"H
 Seat: 17¼"H
 Angle Degree: 60°

60° Outside Wedge Loveseat

451-7460FO	\$1951	\$2120	\$2179	\$2232	\$2333	\$2417	\$2664	\$2830	\$2995	\$3383	\$2206	\$5305	\$5859
-------------------	--------	--------	--------	--------	--------	--------	--------	--------	--------	--------	--------	--------	--------

COM/yds = 4½, COL/sq ft = 99

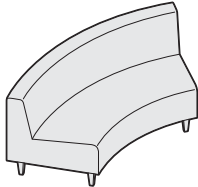

Overall: 28"D 71"W 29½"H
 Inside: 20"D 71"W 12¼"H
 Seat: 17¼"H
 Angle Degree: 60°

60° Inside Wedge Loveseat

 451-7460FI	\$1951	\$2120	\$2179	\$2232	\$2333	\$2417	\$2664	\$2830	\$2995	\$3383	\$2206	\$5305	\$5859
---	--------	--------	--------	--------	--------	--------	--------	--------	--------	--------	--------	--------	--------

COM/yds = 4¾, COL/sq ft = 105

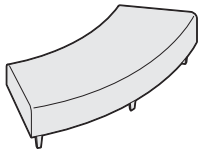

Overall: 28"D 71"W 17¼"H
 Seat: 17¼"H
 Angle Degree: 60°

60° Outside Wedge Bench

451-B7460FO	\$1569	\$1625	\$1668	\$1685	\$1727	\$1768	\$1886	\$1956	\$2035	\$2322	\$1829	\$3240	\$3500
--------------------	--------	--------	--------	--------	--------	--------	--------	--------	--------	--------	--------	--------	--------

COM/yds = 3, COL/sq ft = 66

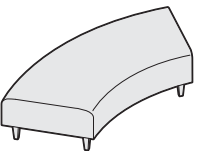

Overall: 28"D 71"W 17¼"H
 Seat: 17¼"H
 Angle Degree: 60°

60° Inside Wedge Bench

451-B7460FI	\$1569	\$1625	\$1668	\$1685	\$1727	\$1768	\$1886	\$1956	\$2035	\$2322	\$1829	\$3240	\$3500
--------------------	--------	--------	--------	--------	--------	--------	--------	--------	--------	--------	--------	--------	--------

COM/yds = 3, COL/sq ft = 66

► Specification Information, continued on next page

 **For Canadian Pricing**
 Multiply U.S. Price by the
 Canadian price factor.
 ► See page 1 for details.

Circa Modular Seating *continued*

DESIGN ALISON SPEAR, AIA DESIGN ORIGIN: UNITED STATES

► Specification Information, continued from previous page

Specification Information

Style Number	U.S. Base Prices											Leather Grades:		
	Fabric Grades:											COL	C	E
	COM	6	7	8	9	10	11	12	13	14				

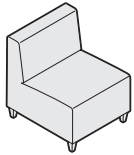

Overall: 28"D 25"W 29½"H
 Inside: 20"D 25"W 12¼"H
 Seat: 17¼"H
 Angle Degree: 0°

Straight Seat Chair

451-2500	\$1118	\$1159	\$1182	\$1197	\$1240	\$1276	\$1371	\$1435	\$1496	\$1704	\$1378	\$2545	\$2758
COM/yds = 2½, COL/sq ft = 55													

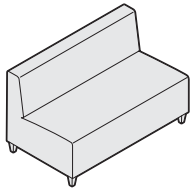

Overall: 28"D 50"W 29½"H
 Inside: 20"D 50"W 12¼"H
 Seat: 17¼"H
 Angle Degree: 0°

Straight Loveseat

451-5000	\$1563	\$1685	\$1732	\$1774	\$1844	\$1916	\$2110	\$2234	\$2362	\$2670	\$1823	\$4195	\$4621
COM/yds = 4, COL/sq ft = 83													

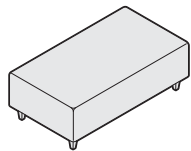

Overall: 28"D 50"W 17¼"H
 Seat: 17¼"H
 Angle Degree: 0°

Straight Bench

451-B5000	\$1424	\$1488	\$1518	\$1534	\$1582	\$1617	\$1735	\$1811	\$1890	\$2153	\$1679	\$3100	\$3348
COM/yds = 3, COL/sq ft = 66													

Tip: Please submit sketch for modular application. One package is required per two chairs.

Ganging Kit

451-GANGPKG	\$ 36	N.A.	N.A.	N.A.	N.A.	N.A.	N.A.	N.A.	N.A.	N.A.	N.A.	N.A.	N.A.
-------------	-------	------	------	------	------	------	------	------	------	------	------	------	------



For Canadian Pricing
 Multiply U.S. Price by the Canadian price factor.
 ► See page 1 for details.

Coalesse

Circa Modular Seating

DESIGN ALISON SPEAR, AIA DESIGN ORIGIN: UNITED STATES

Circa Upholstered Modular Arm Rests—Straight and 15°

DESIGN ALISON SPEAR, AIA DESIGN ORIGIN: UNITED STATES

Tip: Fabrics and leathers will appear loose with comfort wrinkles when upholstered.

Tip: Recommended leathers are Elmosoft Grade C and Elmorustical Grade E.

Tip: Special color match, consult customer service.

Tip: Pricing based on highest grade textile specified.

Tip: Optional steel leg has 90° corner taper shape.

Tip: These colors are different than other Coalesse powder coats.

Tip: For Customer's Own Material or Leather, see necessary requirements, important processing instructions, and ordering information
▶ See *Coalesse Surface Materials Reference Guide*.

Standard Includes		Required to Specify	
	<ul style="list-style-type: none"> • Frame: unibody construction of hardwood plywood utilizing box joinery • Upholstery: multiple densities of polyurethane foam • Top stitch on seams • Legs: hardwood maple or walnut • Ganging brackets and hardware included 		<ol style="list-style-type: none"> 1 Style number 2 Fabric or leather color number for arm rests 3 Wood color number for legs ▶ See <i>Coalesse Surface Materials Reference Guide</i> . <ol style="list-style-type: none"> 4 Options, if selected (see below) ▶ See <i>Coalesse Surface Materials Reference Guide</i> .
Options		U.S. Price	Required to Specify
Surface Materials	• Contrasting fabric	+\$113 per fabric	Add suffix K to the style number and select fabric color number.
	Fire code seating		
	• CAL 133	+\$218	Specify with CAL 133. ▶ See <i>Coalesse Surface Materials Reference Guide</i> .
	Acrylic backer		
	• Backer for straight armrests and 15° armrests	+\$ 19	Specify with acrylic backer. ▶ See <i>Coalesse Surface Materials Reference Guide</i> .
Metal Legs	• Powder coat steel legs	+\$124 per leg	Specify with powder coat steel legs and specify color number: 4138 Graphite Gloss 4140 Arctic White Gloss 4142 Platinum Gloss 4144 Black Gloss 4148 Midnight Brown Gloss

Specification Information														
Style Number	U.S. Base Prices												Leather Grades:	
	Fabric Grades:												COL	C
COM	6	7	8	9	10	11	12	13	14					

Straight Armrest—Intermediate without Legs

451-A1800G	\$681	\$704	\$728	\$745	\$774	\$795	\$ 874	\$ 924	\$ 970	\$1066	\$ 906	\$1819	\$1983
COM/yds = 2¼, COL/sq ft = 50													

Straight Armrest—End of Run with Two Legs

451-A1800ER	\$796	\$819	\$843	\$860	\$889	\$910	\$ 989	\$1039	\$1085	\$1196	\$1021	\$1934	\$2098
COM/yds = 2¼, COL/sq ft = 50													

15° Inside Armrest—Intermediate without Legs

451-A1815FIG	\$681	\$699	\$716	\$733	\$755	\$779	\$ 845	\$ 891	\$ 936	\$1028	\$ 906	\$1713	\$1858
COM/yds = 2, COL/sq ft = 44													

15° Inside Armrest—End of Run with Two Legs

451-A1815FIER	\$842	\$860	\$877	\$894	\$916	\$940	\$1006	\$1052	\$1097	\$1211	\$1067	\$1874	\$2019
COM/yds = 2, COL/sq ft = 44													

▶ Specification Information, continued on next page



Overall: 28"D 18½"W 17"H

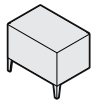

Overall: 28"D 18½"W 23½"H

Tip: Specify left or right facing.



Overall: 28¾"D 18½"W 17"H

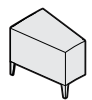

Overall: 28¾"D 18½"W 23½"H

Tip: Specify left or right facing.

Circa Upholstered Modular Arm Rests—Straight and 15°

DESIGN ALISON SPEAR, AIA DESIGN ORIGIN: UNITED STATES

► Specification Information, continued from previous page

Specification Information

Style Number	U.S. Base Prices											Leather Grades:		
	Fabric Grades:											COL	C	E
	COM	6	7	8	9	10	11	12	13	14				

15° Outside Armrest—Intermediate without Legs

451-A1815FOG	\$681	\$699	\$716	\$733	\$755	\$779	\$ 845	\$ 891	\$ 936	\$1028	\$ 906	\$1713	\$1858
COM/yds = 2, COL/sq ft = 44													

15° Outside Armrest—End of Run with Two Legs

451-A1815FOER	\$842	\$860	\$877	\$894	\$916	\$940	\$1006	\$1052	\$1097	\$1211	\$1067	\$1874	\$2019
COM/yds = 2, COL/sq ft = 44													

Ganging Kit

451-GANGPKG	\$ 36	N.A.	N.A.	N.A.	N.A.	N.A.	N.A.	N.A.	N.A.	N.A.	N.A.	N.A.	N.A.
-------------	-------	------	------	------	------	------	------	------	------	------	------	------	------



Overall: 28¾"D 18½"W 17"H

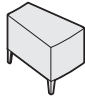

Overall: 28¾"D 18½"W 23½"H

Tip: Specify left or right facing.

Tip: Please submit sketch for modular application. One package is required per two chairs.



For Canadian Pricing
 Multiply U.S. Price by the
 Canadian price factor.
 ► See page 1 for details.

Circa Upholstered Modular Arm rests–30° and Ottoman

DESIGN ALISON SPEAR, AIA DESIGN ORIGIN: UNITED STATES

Tip: For Customer's Own Material or Leather, see necessary requirements, important processing instructions, and ordering information
 ▶ See *Coalesse Surface Materials Reference Guide*.

Tip: Fabrics and leathers will appear loose with comfort wrinkles when upholstered.

Tip: Please submit sketch for modular applications. For ganging, contact customer service. 451-GANGPKG is available for \$34 list (one per two chairs).

Tip: These colors are different than other Coalesse powder coats.

Tip: Recommended leathers are Elmosoft Grade C and Elmorustical Grade E.

Tip: Contrasting option available only on ottoman.

Tip: 90° corner tapered shape leg is standard on arm rests. The ottoman legs are single width taper with no corner.

Tip: Special color match, consult customer service.

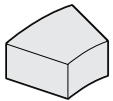

Overall: 29½"D 36¾"W 17"H

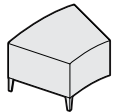

Overall: 29½"D 36¾"W 23½"H
Tip: Specify left or right facing.

Standard Includes	Required to Specify
<ul style="list-style-type: none"> • Frame: unibody construction of hardwood plywood utilizing box joinery • Upholstery: multiple densities of polyurethane foam • Top stitch on seams • Legs: hardwood maple or walnut • Ganging brackets and hardware included 	<ol style="list-style-type: none"> 1 Style number 2 Number of fabrics if contrasting fabric style number is selected 3 Fabric or leather color number for arm rests 4 Wood color number for legs ▶ See <i>Coalesse Surface Materials Reference Guide</i> . 5 Options, if selected (see below) ▶ See <i>Coalesse Surface Materials Reference Guide</i> .

Options	U.S. Price	Required to Specify
Surface Materials <ul style="list-style-type: none"> • Contrasting fabric 	+ \$113 per fabric	Add suffix K to the style number and select fabric color number.
Fire code seating <ul style="list-style-type: none"> • CAL 133 	+ \$218	Specify with CAL 133. ▶ See <i>Coalesse Surface Materials Reference Guide</i> .
Acrylic backer <ul style="list-style-type: none"> • Backer for 30° armrests and ottoman 	+ \$ 29	Specify with acrylic backer. ▶ See <i>Coalesse Surface Materials Reference Guide</i> .
Metal Legs <ul style="list-style-type: none"> • Powder coat steel legs 	+ \$124 per leg	Specify with powder coat steel legs and specify color number: 4138 Graphite Gloss 4140 Arctic White Gloss 4142 Platinum Gloss 4144 Black Gloss 4148 Midnight Brown Gloss

Specification Information													
Style Number	U.S. Base Prices												
	Fabric Grades:												
	COM	6	7	8	9	10	11	12	13	14	Leather Grades:		
											COL	C	E

30° Inside Arm Rest–Intermediate without Legs

451-A3730FIG	\$ 952	\$ 999	\$1026	\$1045	\$1082	\$1116	\$1218	\$1285	\$1351	\$1484	\$1177	\$2405	\$2625
--------------	--------	--------	--------	--------	--------	--------	--------	--------	--------	--------	--------	--------	--------

COM/yds = 3, COL/sq ft = 66

30° Inside Arm Rest–End of Run with Two Legs

451-A3730FIER	\$1076	\$1123	\$1150	\$1169	\$1206	\$1240	\$1342	\$1409	\$1475	\$1626	\$1301	\$2529	\$2749
---------------	--------	--------	--------	--------	--------	--------	--------	--------	--------	--------	--------	--------	--------

COM/yds = 3, COL/sq ft = 66

▶ Specification Information, continued on next page



For Canadian Pricing
 Multiply U.S. Price by the Canadian price factor.
 ▶ See page 1 for details.

Circa Upholstered Modular Arm rests–30° and Ottoman

DESIGN ALISON SPEAR, AIA DESIGN ORIGIN: UNITED STATES

► Specification Information, continued from previous page

Specification Information

Style Number	U.S. Base Prices												Leather Grades:			
	Fabric Grades:												COL	C	E	
	COM	6	7	8	9	10	11	12	13	14						

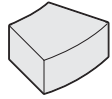

Overall: 29½"D 36¾"W 17"H

30° Outside Arm Rest–Intermediate without Legs

451-A3730FOG	\$ 952	\$ 999	\$1026	\$1045	\$1082	\$1116	\$1218	\$1285	\$1351	\$1484	\$1177	\$2405	\$2625
--------------	--------	--------	--------	--------	--------	--------	--------	--------	--------	--------	--------	--------	--------

COM/yds = 3, COL/sq ft = 66

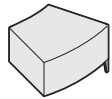

Overall: 29½"D 36¾"W 23½"H
Tip: Specify left or right facing.

30° Outside Arm Rest–End of Run with Two Legs

451-A3730FOER	\$1076	\$1123	\$1150	\$1169	\$1206	\$1240	\$1342	\$1409	\$1475	\$1626	\$1301	\$2529	\$2749
---------------	--------	--------	--------	--------	--------	--------	--------	--------	--------	--------	--------	--------	--------

COM/yds = 3, COL/sq ft = 66

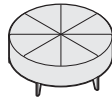

Overall: 42"Dia. 17"H

Round Ottoman with Five Legs

451-B42RD	\$1541	\$1593	\$1620	\$1644	\$1690	\$1722	\$1835	\$1908	\$1977	\$2190	\$1766	\$3101	\$3337
-----------	--------	--------	--------	--------	--------	--------	--------	--------	--------	--------	--------	--------	--------

COM/yds = 3¼, COL/sq ft = 72



For Canadian Pricing
Multiply U.S. Price by the Canadian price factor.
► See page 1 for details.

Circa Freestanding Tables

DESIGN ALISON SPEAR, AIA DESIGN ORIGIN: UNITED STATES

Tip: Galvanized aluminum liner is not water tight, plastic liner recommended.

Tip: Please submit sketch for modular applications.

Tip: These colors are different than other Coalesse powder coats.

Tip: Optional steel leg has a 90° corner tapered shape.

Standard Includes	Required to Specify
-------------------	---------------------

- Frame: hardwood veneered panels
- Top and legs: hardwood maple or walnut
- Planter: galvanized aluminum

- 1 Style number
- 2 Wood color number for legs and top
▶ See *Coalesse Surface Materials Reference Guide*.
- 3 Options, if selected (see below)
▶ See *Coalesse Surface Materials Reference Guide*.

Options	U.S. Price	Required to Specify
---------	------------	---------------------

Metal Legs	<ul style="list-style-type: none"> • Powder coat steel legs 	+\$124 per leg Specify with <i>powder coat steel legs</i> and specify color number: 4138 Graphite Gloss 4140 Arctic White Gloss 4142 Platinum Gloss 4144 Black Gloss 4148 Midnight Brown Gloss
-------------------	--	--

Specification Information

Style Number	U.S. Base Prices Walnut or Maple
--------------	-------------------------------------

30° Freestanding Low Table with Four Legs

45-T3730L	\$1787
-----------	--------

30° Freestanding High Table with Four Legs

45-T3730H	\$2395
-----------	--------

60° Freestanding Table-Planter with Five Legs

45-T7460HP	\$4767
------------	--------

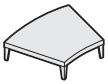

Overall: 29½"D 36⅝"W 8½"H

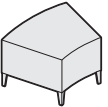

Overall: 29"D 36⅞"W 22½"H

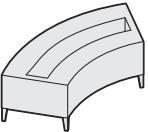

Overall: 33¼"D 70¾"W 22½"H



For Canadian Pricing
 Multiply U.S. Price by the Canadian price factor.
 ▶ See page 1 for details.

Circa Freestanding Tables

DESIGN ALISON SPEAR, AIA DESIGN ORIGIN: UNITED STATES

Tip: Please submit sketch for modular applications.

Tip: These colors are different than other Coalesse powder coats.

Tip: Optional steel leg has 90° corner taper shape on all tables except 42" round. 42" round has single width taper leg with no corner.

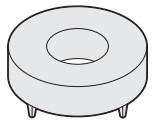

Overall: 42" dia. 15¾"H

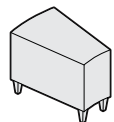

Overall: 28"D 18½"W 22½"H
Angle Degree: 15°

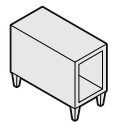

Overall: 27½"D 13½"W 22½"H
Angle Degree: 0°

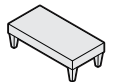

Overall: 27½"D 13½"W 8½"H
Angle Degree: 0°

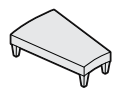

Overall: 28"D 18½"W 8½"H
Angle Degree: 15°

Standard Includes	Required to Specify
-------------------	---------------------

- Frame: hardwood veneered panels
- Top and legs: hardwood maple or walnut

- 1 Style number
 - 2 Wood color number for legs and top
 - 3 Options, if selected (see below)
- ▶ See *Coalesse Surface Materials Reference Guide*.
▶ See *Coalesse Surface Materials Reference Guide*.

Options	U.S. Price	Required to Specify
---------	------------	---------------------

Glass Insert	<ul style="list-style-type: none"> • Glass insert for round table ¾" thick with translucent coating on bottom surface square edge detail 	+\$232 Specify <i>with glass insert</i> .
Metal Legs	<ul style="list-style-type: none"> • Powder coat steel legs 	+\$124 per leg Specify <i>with powder coat steel legs</i> and specify color number: 4138 Graphite Gloss 4140 Arctic White Gloss 4142 Platinum Gloss 4144 Black Gloss 4148 Midnight Brown Gloss
Power/Data Module (45-T42RD only)	<ul style="list-style-type: none"> • Two power/two data ports for round table only matte black or silver mica 	+\$343 Specify finish color number.

Specification Information

Style Number	U.S. Base Prices	
	Walnut or Maple	Sunburst Top

Freestanding Round Table

45-T42RD	\$3234	\$3484
----------	--------	--------

Freestanding High Wedge Table

45-T1815H	\$1936	N.A.
-----------	--------	------

Freestanding High Straight Table

45-T1300H	\$2283	N.A.
-----------	--------	------

Freestanding Low Straight Table

45-T1300L	\$1495	N.A.
-----------	--------	------

Freestanding Low Wedge Table

45-T1815L	\$1495	N.A.
-----------	--------	------

Circa Ganging Tables

DESIGN ALISON SPEAR, AIA DESIGN ORIGIN: UNITED STATES

Standard Includes	Required to Specify
<ul style="list-style-type: none"> • Frame: hardwood veneered panels • Top and legs: hardwood maple or walnut • Ganging brackets and hardware included 	1 Style number 2 Wood color number for legs and top ▶ See <i>Coalesse Surface Materials Reference Guide</i> . 3 Options, if selected (see below) ▶ See <i>Coalesse Surface Materials Reference Guide</i> .

Tip: Optional steel leg is a 90° corner taper leg.

Tip: These colors are different than other Coalesse powder coats.

Tip: Please submit sketch for modular applications. For ganging, contact customer service.

Options	U.S. Price	Required to Specify
Metal Legs <ul style="list-style-type: none"> • Powder coat steel legs on end-of-run tables only 	+ \$124 per leg	Specify with <i>powder coat steel legs</i> and specify color number: 4138 Graphite Gloss 4140 Arctic White Gloss 4142 Platinum Gloss 4144 Black Gloss 4148 Midnight Brown Gloss
Leg Position <ul style="list-style-type: none"> • Left-side facing • Right-side facing 	No cost No cost	Specify with <i>left-side legs</i> . Specify with <i>right-side legs</i> .

Specification Information	
Style Number	U.S. Base Price Walnut or Maple

Ganging Low Wedge Table

45-T1815LG \$1176

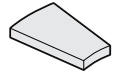

Overall: 28"D 18½"W 8½"H
Angle Degree: 15°

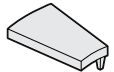

Overall: 28"D 18½"W 8½"H
Angle Degree: 15°

End-of-Run Low Wedge Table

45-T1815LER \$1333

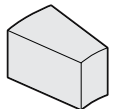

Overall: 28"D 18½"W 22½"H
Angle Degree: 15°

Ganging High Wedge Table

45-T1815HG \$1622

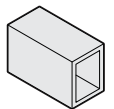

Overall: 27½"D 13½"W 22½"H
Angle Degree: 0°

Ganging High Straight Table

45-T1300HG \$1966

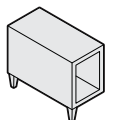

Overall: 27½"D 13½"W 22½"H
Angle Degree: 0°

End-of-Run High Straight Table

45-T1300HER \$2155

▶ Specification Information, continued on next page



For Canadian Pricing
 Multiply U.S. Price by the Canadian price factor.
 ▶ See page 1 for details.

Circa Ganging Tables

DESIGN ALISON SPEAR, AIA DESIGN ORIGIN: UNITED STATES

► Specification Information, continued from previous page

Specification Information

Style Number	U.S. Base Price
	Walnut or Maple

End-of-Run High Wedge Table

45-T1815HER \$1774

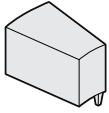

Overall: 28"D 18½"W 22½"H
Angle Degree: 15°

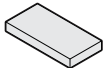

Overall: 27½"D 13½"W 8½"H
Angle Degree: 0°

Ganging Low Straight Table

45-T1300LG \$1148

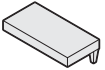

Overall: 27½"D 13½"W 8½"H
Angle Degree: 0°

End-of-Run Low Straight Table

45-T1300LER \$1333

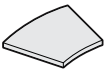

Overall: 29"D 36⅝"W 2"H
(8½" from floor once assembled)

30° Ganging without Legs

45-T3730LG \$1440

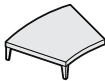

Overall: 29"D 36⅝"W 8½"H

30° End-of-Run with Two Legs

45-T3730LER \$1612



Overall: 13¾"D 27½"W 22¼"H
(8½" from floor once assembled)
Tip: Model 45-T28HER has only a single width tapered leg, no corner.

30° End-of-Run with One Leg

45-T28HER \$1738

► Specification Information, continued on next page

Options for Creating 90° Applications:

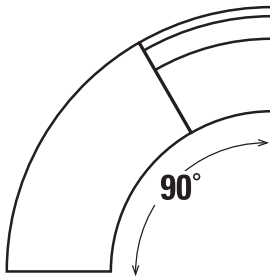

- (1) 30° Outside or Inside Facing Wedge Seat
- (1) 60° Wedge Bench

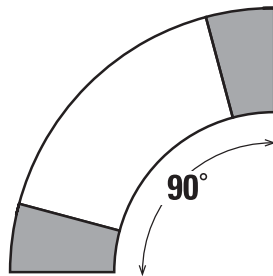

- (2) 15° Wedge Tables
- (1) 60° Wedge Bench

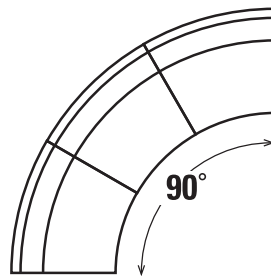

- (3) 30° Outside or Inside Facing Wedge Seats

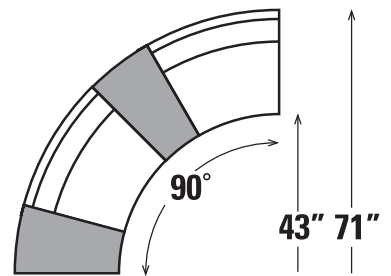

- (2) 30° Outside or Inside Facing Wedge Seats
- (2) 15° Wedge Tables

Circa Ganging Tables *continued*

DESIGN ALISON SPEAR, AIA DESIGN ORIGIN: UNITED STATES

► Specification Information, continued from previous page

Specification Information

Style Number	U.S. Base Price
	Walnut or Maple

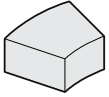

Overall: 29"D 36⁵/₈"W 16"H

30° Ganged High Table without Legs

45-T3730HG \$2052

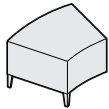

Overall: 29"D 36⁵/₈"W 22¹/₂"H

30° End-of-Run High Table with Two Legs

45-T3730HER \$2219

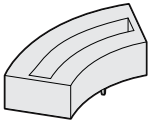

Overall: 33¹/₄"D 70³/₄"W 22¹/₂"H

60° Ganged Table-Planter with Two Legs Front and Back

45-T7460HPG \$4559

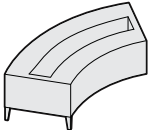

Overall: 33¹/₄"D 70³/₄"W 22¹/₂"H

60° End-of-Run Table-Planter with Three Legs

45-T7460HPER \$4601



For Canadian Pricing
 Multiply U.S. Price by the
 Canadian price factor.
 ► See page 1 for details.

Circa Multi-Fabric Diagram

Applies to all Circa models including: Straight Seat, Wedge, and Straight Loveseat

TO: _____

FROM: _____

DATE: _____

FAX...888.413.5161

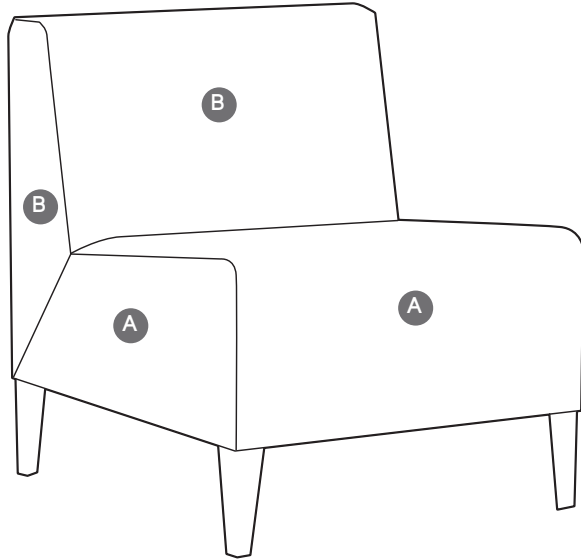

A Upholstery Selection (default for entire unit if B is not selected):

B Back: _____

***\$113 list per contrasting fabric specified. List price based on highest fabric grade usage.**

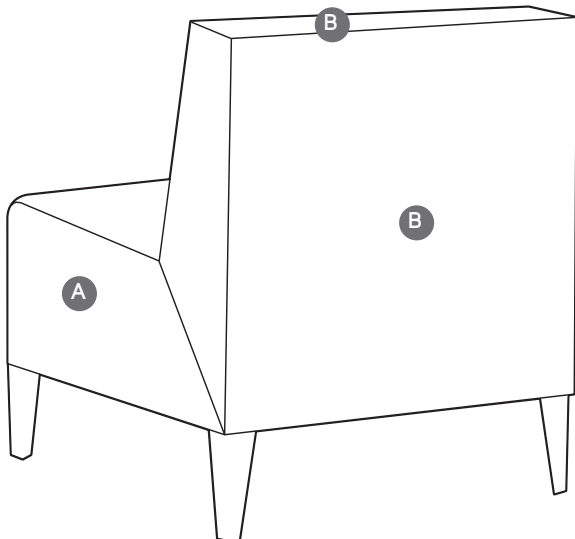

Specify model below:

451-7460FOK Outside Facing

451-7460FIK Inside Facing

451-5000K

451-2500K

451-3730FOK Outside Facing

451-3730FIK Inside Facing



For Canadian Pricing
 Multiply U.S. Price by the
 Canadian price factor.
 ▶ See page 1 for details.

Club/Club Mobile **X4/14**

DESIGN ERNST M. DETTINGER DESIGN ORIGIN: GERMANY

Tip: Fabrics and leathers will appear loose with comfort wrinkles when upholstered.

Tip: Steelcase finishes available at no upcharge. Special match finishes are available.
▶ See *Coalesse Surface Materials Reference Guide*.

Tip: Recommended leathers are Elmosoft Grade C and Elmorustical Grade E.

Tip: Special color match, consult customer service.

Tip: For Customer's Own Material or Leather, see necessary requirements, important processing instructions, and ordering information
▶ See *Coalesse Surface Materials Reference Guide*.

Tip: Specify tablet from facing position. Standard laminate colors available.
▶ See *Coalesse Surface Materials Reference Guide*.

Tip: Tablet dimensions are 18 1/4" x 12 1/2".

Tip: Soft casters are not available.

Standard Includes		Required to Specify	
	<ul style="list-style-type: none"> • Frame: selected hardwood and wood veneer • Club: <ul style="list-style-type: none"> - Legs: solid wood - Glides: non-adjustable • Club Mobile: <ul style="list-style-type: none"> - Legs: black - Hard dual wheel casters: black - Tablet: pivoting laminate worksurface • Upholstery: multiple densities of polyurethane and polyester fiber 		<ol style="list-style-type: none"> 1 Style number 2 Number of fabrics if contrasting fabric style number is selected 3 Fabric or leather color number for seat, back, and fully upholstered arms 4 Wood color number for legs on Club ▶ See <i>Coalesse Surface Materials Reference Guide</i> .
Options		U.S. Price	Required to Specify
Surface Materials	• Contrasting fabric	+\$113 per fabric	Add suffix K to the style number and select fabric color number. Specify with <i>contrasting welt</i> and select fabric color number.
	• Contrasting welt	+\$125	
	Fire code seating		
	• CAL 133 for chair	+\$218	Specify with <i>CAL 133</i> .
	• CAL 133 for two-seat sofa	+\$437	Specify with <i>CAL 133</i> .
	• CAL 133 for three-seat sofa	+\$568	Specify with <i>CAL 133</i> . ▶ See <i>Coalesse Surface Materials Reference Guide</i> .
	Acrylic backer		
	• Backer for chair	+\$ 33	Specify with <i>acrylic backer</i> .
	• Backer for two-seat sofa	+\$ 52	Specify with <i>acrylic backer</i> .
	• Backer for three-seat sofa	+\$ 69	Specify with <i>acrylic backer</i> . ▶ See <i>Coalesse Surface Materials Reference Guide</i> .
Tablet	Mobile		
	• Wood tablet	+\$256	Specify with <i>wood tablet</i> and select wood color number.
Casters	• Black hard casters available on model 287 only	+\$132	Specify with <i>black hard casters</i> .

Specification Information														
Style Number	U.S. Base Prices												Leather Grades:	
	Fabric Grades:												COL	C
COM	6	7	8	9	10	11	12	13	14					

Club Chair

287 X4/14	\$1453	\$1557	\$1622	\$1669	\$1812	\$1871	\$1929	\$2018	\$2027	\$2234	\$1756	\$3252	\$3714
COM/yds = 3 3/4, COL/sq ft = 83													



Overall: 29"D 27 1/2"W 31"H
Inside: 19 1/2"D 19 1/2"W 13"H
Seat: 18"H
Arm: 26 1/2"H

Club Two-Seat Sofa

287-2 X4/14	\$2712	\$2758	\$2839	\$2934	\$3088	\$3265	\$3485	\$3543	\$3575	\$3962	\$3001	\$4802	\$5375
COM/yds = 5 1/2, COL/sq ft = 121													

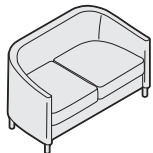

Overall: 29 3/4"D 55"W 32"H
Inside: 19 1/2"D 47"W 15"H
Seat: 18"H
Arm: 26 1/2"H

▶ Specification Information, continued on next page

X4/14 = Last order entry
April 20, 2014

► Specification Information, continued from previous page

Specification Information

Style Number	U.S. Base Prices													
	Fabric Grades:											Leather Grades:		
	COM	6	7	8	9	10	11	12	13	14	COL	C	E	

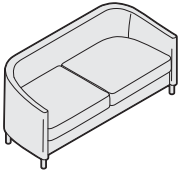

Overall: 29¾"D 72"W 33"H
 Inside: 19½"D 64"W 16"H
 Seat: 18"H
 Arm: 26½"H

Club Three-Seat Sofa

287-3 X4/14	\$3627	\$3700	\$3812	\$3955	\$4157	\$4410	\$4665	\$4724	\$4765	\$5284	\$3893	\$6284	\$6938
--------------------	--------	--------	--------	--------	--------	--------	--------	--------	--------	--------	--------	--------	--------

COM/yds = 6½, COL/sq ft = 143

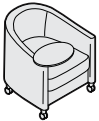

Overall: 29"D 27½"W 31"H
 Inside: 19½"D 19½"W 13"H
 Seat: 18"H
 Arm: 26½"H

Club Mobile Chair-Tablet Left Facing

287MTL X4/14	\$1766	\$1918	\$1952	\$1988	\$2089	\$2266	\$2407	\$2493	\$2514	\$2746	\$2032	\$3518	\$4004
---------------------	--------	--------	--------	--------	--------	--------	--------	--------	--------	--------	--------	--------	--------

COM/yds = 3¾, COL/sq ft = 83



Overall: 29"D 27½"W 31"H
 Inside: 19½"D 19½"W 13"H
 Seat: 18"H
 Arm: 26½"H

Club Mobile Chair-Tablet Right Facing

287MTR X4/14	\$1766	\$1918	\$1952	\$1988	\$2089	\$2266	\$2407	\$2493	\$2514	\$2746	\$2032	\$3518	\$4004
---------------------	--------	--------	--------	--------	--------	--------	--------	--------	--------	--------	--------	--------	--------

COM/yds = 3¾, COL/sq ft = 83

Lounge Seating



For Canadian Pricing
 Multiply U.S. Price by the
 Canadian price factor.
 ► See page 1 for details.

X4/14 = Last order entry
 April 20, 2014

Club Grande **X4/14**

DESIGN ERNST M. DETTINGER DESIGN ORIGIN: GERMANY

Tip: Steelcase wood finishes available at no upcharge. Special match finishes are available.

Tip: Fabrics and leathers will appear loose with comfort wrinkles when upholstered.

Tip: Recommended leathers are Elmosoft Grade C and Elmorustical Grade E.

Tip: Special color match, consult customer service.

Tip: For Customer's Own Material or Leather, see necessary requirements, important processing instructions, and ordering information
 ▶ See *Coalesse Surface Materials Reference Guide*.

Tip: Specify tablet from facing position. Standard laminate colors available.

▶ See *Coalesse Surface Materials Reference Guide*.

Standard Includes		Required to Specify	
	<ul style="list-style-type: none"> • Frame: selected hardwood and molded wood veneer • Legs: solid wood • Non-adjustable black glides • Upholstery: multiple densities of polyurethane and polyester fiber 		1 Style number 2 Number of fabrics if contrasting fabric style number is selected 3 Fabric or leather color number for seat, back, and fully upholstered arms 4 Wood color number for legs ▶ See <i>Coalesse Surface Materials Reference Guide</i> . 5 Options, if selected (see below) ▶ See <i>Coalesse Surface Materials Reference Guide</i> .
Options		U.S. Price	Required to Specify
Surface Materials	• Contrasting fabric	+\$113 per fabric	Add suffix K to the style number and select fabric color number. Specify with <i>contrasting welt</i> and select fabric color number.
	• Contrasting welt	+\$125	
	Fire code seating		
	• CAL 133 for chair	+\$218	Specify with <i>CAL 133</i> .
	• CAL 133 for two-seat sofa	+\$437	Specify with <i>CAL 133</i> .
	• CAL 133 for three-seat sofa	+\$568	Specify with <i>CAL 133</i> .
	• CAL 133 for 30"W bariatric chair	+\$285	Specify with <i>CAL 133</i> .
	• CAL 133 for 40"W bariatric chair	+\$313	Specify with <i>CAL 133</i> .
	Acrylic backer		
	• Backer for chair	+\$ 39	Specify with <i>acrylic backer</i> .
	• Backer for two-seat sofa	+\$ 69	Specify with <i>acrylic backer</i> .
	• Backer for three-seat sofa	+\$ 79	Specify with <i>acrylic backer</i> .
	• Backer for 30"W bariatric chair	+\$ 50	Specify with <i>acrylic backer</i> .
	• Backer for 40"W bariatric chair	+\$ 50	Specify with <i>acrylic backer</i> .
			▶ See <i>Coalesse Surface Materials Reference Guide</i> .
Casters	• Black hard casters available on model 289 only	+\$132	Specify with black hard casters.

Specification Information													
Style Number	U.S. Base Prices											Leather Grades:	
	Fabric Grades:											COL	C
	COM	6	7	8	9	10	11	12	13	14			

Chair													
289 X4/14	\$1879	\$1905	\$1978	\$2060	\$2238	\$2392	\$2534	\$2627	\$2760	\$2892	\$2145	\$3590	\$4075
COM/yds = 4¼, COL/sq ft = 94													

Two-Seat Sofa													
289-2 X4/14	\$2901	\$2957	\$3064	\$3193	\$3367	\$3595	\$3832	\$3886	\$3899	\$4313	\$3167	\$5528	\$6172
COM/yds = 6½, COL/sq ft = 143													

▶ Specification Information, continued on next page



Overall: 33"D 32½"W 29¾"H
 Inside: 21"D 22"W 12¾"H
 Seat: 17"H
 Arm: 24½"H

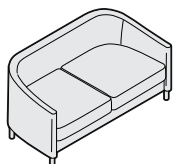

Overall: 33"D 64"W 29¾"H
 Inside: 21"D 53½"W 12¾"H
 Seat: 17"H
 Arm: 24½"H

X4/14 = Last order entry
 April 20, 2014

► Specification Information, continued from previous page

Specification Information

Style Number	U.S. Base Prices														Leather Grades:		
	Fabric Grades:														COL	C	E
	COM	6	7	8	9	10	11	12	13	14							

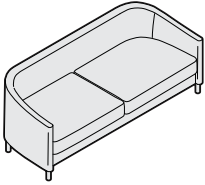

Overall: 33"D 84"W 29¾"H
 Inside: 21"D 73½"W 12¾"H
 Seat: 17"H
 Arm: 24½"H

Three-Seat Sofa

289-3 X4/14	\$3770	\$3834	\$3940	\$4052	\$4229	\$4441	\$4779	\$4849	\$4895	\$5434	\$4073	\$6575	\$7260
--------------------	--------	--------	--------	--------	--------	--------	--------	--------	--------	--------	--------	--------	--------

COM/yds = 7¼, COL/sq ft = 160

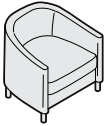

Overall: 33"D 40½"W 29¾"H
 Inside: 21"D 30"W 12¾"H
 Seat: 17"H
 Arm: 24½"H

Bariatric Chair—30"W Large Scale

289B-30 X4/14	\$2762	\$2901	\$2961	\$3001	\$3091	\$3155	\$3303	\$3446	\$3516	\$3908	\$3040	\$5668	\$6134
----------------------	--------	--------	--------	--------	--------	--------	--------	--------	--------	--------	--------	--------	--------

COM/yds = 5¼, COL/sq ft = 116

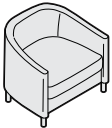

Overall: 33"D 50½"W 29¾"H
 Inside: 21"D 40"W 12¾"H
 Seat: 17"H
 Arm: 24½"H

Bariatric Chair—40"W Large Scale

289B-40 X4/14	\$3195	\$3370	\$3454	\$3494	\$3601	\$3689	\$3872	\$4044	\$4136	\$4591	\$3473	\$6732	\$7420
----------------------	--------	--------	--------	--------	--------	--------	--------	--------	--------	--------	--------	--------	--------

COM/yds = 6½, COL/sq ft = 143

Lounge Seating



For Canadian Pricing
 Multiply U.S. Price by the
 Canadian price factor.
 ► See page 1 for details.

X4/14 = Last order entry
 April 20, 2014

Coupe

DESIGN DENNIE PIMENTAL / JOHN DUFFY DESIGN ORIGIN: UNITED STATES

 = Available in Rapid10.

Tip: Fabrics and leathers will appear loose with comfort wrinkles when upholstered.

Tip: Recommended leathers are Elmosoft Grade C and Elmorustical Grade E.

Tip: Special color match, consult customer service.

Tip: Pricing based on highest grade textile specified.

Tip: For Customer's Own Material or Leather, see necessary requirements, important processing instructions, and ordering information
 ▶ See *Coalesse Surface Materials Reference Guide*.

Standard Includes	Required to Specify
<ul style="list-style-type: none"> • Frame: unibody construction of hardwood plywood utilizing box joinery • Legs: solid beech • Glides: non-adjustable • Upholstery: multiple densities of laminated polyurethane foam and polyester fiber on seat and back with top stitch sewing detail 	1 Style number 2 Number of fabrics if contrasting fabric style number is selected 3 Wood color number for legs ▶ See <i>Coalesse Surface Materials Reference Guide</i> . 4 Fabric or leather color number for upholstery on seat and back 5 Options, if selected (see below) ▶ See <i>Coalesse Surface Materials Reference Guide</i> .

Options	U.S. Price	Required to Specify
Surface Materials <ul style="list-style-type: none"> • Contrasting fabric 	+\$113 per fabric	Add suffix K to the style number and select fabric color number.
Fire code seating <ul style="list-style-type: none"> • CAL 133 for chair and ottoman • CAL 133 for loveseat • CAL 133 for sofa 	+\$218 +\$437 +\$568	Specify with CAL 133. Specify with CAL 133. Specify with CAL 133. ▶ See <i>Coalesse Surface Materials Reference Guide</i> .
Acrylic backer <ul style="list-style-type: none"> • Backer for chair • Backer for loveseat • Backer for sofa • Backer for ottoman 	+\$ 37 +\$ 50 +\$ 60 +\$ 17	Specify with acrylic backer. Specify with acrylic backer. Specify with acrylic backer. Specify with acrylic backer. ▶ See <i>Coalesse Surface Materials Reference Guide</i> .
Legs <ul style="list-style-type: none"> • Brushed aluminum • Powder coat 	+\$143 +\$113	Specify with brushed aluminum legs. Specify with powder coat legs and select color: 4138 Graphite Gloss 4140 Arctic White Gloss 4142 Platinum Gloss 4144 Black Gloss Specify with acrylic legs.
<ul style="list-style-type: none"> • Acrylic: clear 	+\$199	Specify with acrylic legs.
Casters <ul style="list-style-type: none"> • Ottoman casters 	+\$125	Specify with casters.

Specification Information													
Style Number	U.S. Base Prices											Leather Grades:	
	Fabric Grades:											COL	C
COM	6	7	8	9	10	11	12	13	14				

Chair

 470	\$1226	\$1320	\$1359	\$1389	\$1454	\$1502	\$1660	\$1761	\$1891	\$2143	\$1476	\$3370	\$3711
COM/yds = 4¼, COL/sq ft = 94													

Loveseat

470-2	\$1865	\$1998	\$2058	\$2099	\$2182	\$2252	\$2466	\$2602	\$2781	\$3895	\$2115	\$4874	\$5153
COM/yds = 5¾, COL/sq ft = 127													

▶ Specification Information, continued on next page

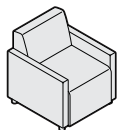

Overall: 28"D 26½"W 30"H
 Inside: 20"D 22"W 13"H
 Seat: 17"H
 Arm: 22"H

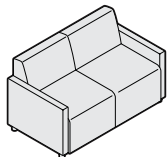

Overall: 28"D 52½"W 30"H
 Inside: 20"D 48"W 13"H
 Seat: 17"H
 Arm: 22"H

Coupe

DESIGN DENNIE PIMENTAL / JOHN DUFFY DESIGN ORIGIN: UNITED STATES

► Specification Information, continued from previous page

Specification Information

Style Number	U.S. Base Prices											Leather Grades:		
	Fabric Grades:											COL	C	E
	COM	6	7	8	9	10	11	12	13	14				

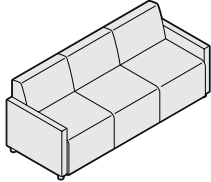

Overall: 28"D 72"W 30"H
 Inside: 20"D 67½"W 13"H
 Seat: 17"H
 Arm: 22"H

Sofa

470-3	\$2166	\$2335	\$2400	\$2458	\$2553	\$2637	\$2896	\$3067	\$3289	\$3735	\$2409	\$5561	\$6122
-------	--------	--------	--------	--------	--------	--------	--------	--------	--------	--------	--------	--------	--------

COM/yds = 7, COL/sq ft = 154



Overall: 20"D 25"W 18"H

Ottoman

470-H	\$ 600	\$ 626	\$ 646	\$ 663	\$ 685	\$ 709	\$ 780	\$ 834	\$ 894	\$ 858	\$ 841	\$1717	\$1880
-------	--------	--------	--------	--------	--------	--------	--------	--------	--------	--------	--------	--------	--------

COM/yds = 2, COL/sq ft = 44



For Canadian Pricing
 Multiply U.S. Price by the
 Canadian price factor.
 ► See page 1 for details.

Coupe Grande/Mobile

DESIGN DENNIE PIMENTAL / JOHN DUFFY DESIGN ORIGIN: UNITED STATES

 = Available in Rapid10.

Tip: Fabrics and leathers will appear loose with comfort wrinkles when upholstered.

Tip: Recommended leathers are Elmosoft Grade C and Elmorustical Grade E.

Tip: Special color match, consult customer service.

Tip: For Customer's Own Material or Leather, see necessary requirements, important processing instructions, and ordering information
 ▶ See *Coalesse Surface Materials Reference Guide*.

Tip: Pricing based on highest grade textile specified.

Standard Includes		Required to Specify	
	<ul style="list-style-type: none"> • Frame: unibody construction of hardwood plywood utilizing box joinery • Legs: solid beech • Glides: non-adjustable • Upholstery: multiple densities of laminated polyurethane foam and polyester fiber on seat and back with top stitch sewing detail • On 476M model: <ul style="list-style-type: none"> - Casters: swivel hard - Locking and non-locking wheels Tablet: <ul style="list-style-type: none"> - Laminate - 13½" diameter 		<ol style="list-style-type: none"> 1 Style number 2 Number of fabrics if contrasting fabric style number is selected 3 Wood color number for legs ▶ See <i>Coalesse Surface Materials Reference Guide</i> . <ol style="list-style-type: none"> 4 Fabric or leather color number for seat and back 5 Laminate color number for 476M tablet, if selected 6 Options, if selected (see below) ▶ See <i>Coalesse Surface Materials Reference Guide</i> .
Options		U.S. Price	Required to Specify
Surface Materials	• Contrasting fabric	+\$113 per fabric	Add suffix K to the style number and select fabric color number.
	Fire code seating		
	• CAL 133 for chair	+\$218	Specify with CAL 133.
	• CAL 133 for loveseat	+\$437	Specify with CAL 133.
	• CAL 133 for sofa	+\$568	Specify with CAL 133. ▶ See <i>Coalesse Surface Materials Reference Guide</i> .
	Acrylic backer		
	• Backer for chair	+\$ 44	Specify with acrylic backer.
	• Backer for loveseat	+\$ 58	Specify with acrylic backer.
	• Backer for sofa	+\$ 69	Specify with acrylic backer. ▶ See <i>Coalesse Surface Materials Reference Guide</i> .
Casters	• Soft casters	No cost	Specify with soft casters.
Legs	• Brushed aluminum	+\$143	Specify with brushed aluminum legs.
	• Powder coat	+\$113	Specify with powder coat legs and select color: 4138 Graphite Gloss 4140 Arctic White Gloss 4142 Platinum Gloss 4144 Black Gloss Specify with acrylic legs.
	• Acrylic: clear	+\$199	
Tablet 476M only	• Anodized aluminum	+\$205	Specify with anodized aluminum tablet.
	• Wood	+\$113	Specify with wood tablet and select wood color number.
	• Omit tablet	-\$143	Specify with remove tablet.

Specification Information													
Style Number	U.S. Base Prices											Leather Grades:	
	Fabric Grades:											COL	C
COM	6	7	8	9	10	11	12	13	14				

Chair													
 476	\$1409	\$1519	\$1567	\$1602	\$1678	\$1738	\$1922	\$2045	\$2201	\$2493	\$1652	\$3894	\$4295

COM/yds = 5, COL/sq ft = 110
 ▶ Specification Information, continued on next page

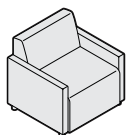

Overall: 28"D 31"W 30"H
 Inside: 20"D 25"W 13"H
 Seat: 17"H
 Arm: 22"H

Coupe Grande/Mobile

DESIGN DENNIE PIMENTAL / JOHN DUFFY DESIGN ORIGIN: UNITED STATES

► Specification Information, continued from previous page

Specification Information

Style Number	U.S. Base Prices											Leather Grades:		
	Fabric Grades:											COL	C	E
	COM	6	7	8	9	10	11	12	13	14				

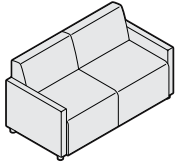

Overall: 28"D 61½"W 30"H
 Inside: 20"D 55½"W 13"H
 Seat: 17"H
 Arm: 22"H

Loveseat

476-2	\$2632	\$2771	\$2831	\$2877	\$2961	\$3032	\$3256	\$3398	\$3590	\$4109	\$2873	\$5571	\$6050
--------------	--------	--------	--------	--------	--------	--------	--------	--------	--------	--------	--------	--------	--------

COM/yds = 6, COL/sq ft = 132

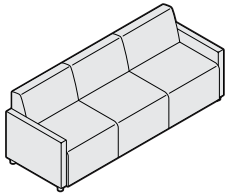

Overall: 28"D 80"W 30"H
 Inside: 20"D 74"W 13"H
 Seat: 17"H
 Arm: 22"H

Sofa

476-3	\$2998	\$3166	\$3231	\$3290	\$3385	\$3473	\$3727	\$3898	\$4119	\$4715	\$3239	\$6392	\$6954
--------------	--------	--------	--------	--------	--------	--------	--------	--------	--------	--------	--------	--------	--------

COM/yds = 7, COL/sq ft = 154

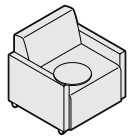

Overall: 28"D 31"W 30"H
 Inside: 20"D 25"W 13"H
 Seat: 17"H
 Arm: 22"H

Mobile Chair

476M	\$1928	\$2038	\$2086	\$2121	\$2192	\$2257	\$2433	\$2559	\$2720	\$3104	\$2171	\$4406	\$4809
-------------	--------	--------	--------	--------	--------	--------	--------	--------	--------	--------	--------	--------	--------

COM/yds = 5, COL/sq ft = 110

Lounge Seating

 **For Canadian Pricing**
 Multiply U.S. Price by the
 Canadian price factor.
 ► See page 1 for details.

Coupe Wood

DESIGN DENNIE PIMENTAL / JOHN DUFFY DESIGN ORIGIN: UNITED STATES

Tip: Fabrics and leathers will appear loose with comfort wrinkles when upholstered.

Tip: Recommended leathers are Elmosoft Grade C and Elmorustical Grade E.

Tip: Special color match, consult customer service.

Tip: For Customer's Own Material or Leather, see necessary requirements, important processing instructions, and ordering information
 ▶ See *Coalesse Surface Materials Reference Guide*.

Standard Includes	Required to Specify
<ul style="list-style-type: none"> • Frame: unibody construction of hardwood plywood utilizing box joinery • Legs: solid wood • Glides: non-adjustable • Upholstery: multiple densities of laminated polyurethane foam and polyester fiber on seat and back with top stitch sewing detail 	<ol style="list-style-type: none"> 1 Style number 2 Number of fabrics if contrasting fabric style number is selected 3 Wood color number for legs ▶ See <i>Coalesse Surface Materials Reference Guide</i> . <ol style="list-style-type: none"> 4 Fabric or leather color number for upholstery on seat and back 5 Options, if selected (see below) ▶ See <i>Coalesse Surface Materials Reference Guide</i> .

Options	U.S. Price	Required to Specify
Surface Materials <ul style="list-style-type: none"> • Contrasting fabric 	+\$113 per fabric	Add suffix K to the style number and select fabric color number.
Fire code seating <ul style="list-style-type: none"> • CAL 133 for chair • CAL 133 for loveseat • CAL 133 for sofa 	+\$218 +\$437 +\$568	Specify with CAL 133. Specify with CAL 133. Specify with CAL 133. ▶ See <i>Coalesse Surface Materials Reference Guide</i> .
Acrylic backer <ul style="list-style-type: none"> • Backer for chair • Backer for loveseat • Backer for sofa 	+\$ 37 +\$ 50 +\$ 60	Specify with acrylic backer. Specify with acrylic backer. Specify with acrylic backer. ▶ See <i>Coalesse Surface Materials Reference Guide</i> .
Legs <ul style="list-style-type: none"> • Brushed aluminum • Powder coat 	+\$143 +\$113	Specify with brushed aluminum legs. Specify with powder coat legs and select color: 4138 Graphite Gloss 4140 Arctic White Gloss 4142 Platinum Gloss 4144 Black Gloss Specify with acrylic legs.
<ul style="list-style-type: none"> • Acrylic: clear 	+\$199	

Specification Information													
Style Number	U.S. Base Prices											Leather Grades:	
	Fabric Grades:											COL	C
	COM	6	7	8	9	10	11	12	13	14			

Chair

473MAPLE	\$3134	\$3220	\$3267	\$3297	\$3356	\$3403	\$3563	\$3669	\$3799	\$4392	\$3377	\$5270	\$5612
473WALNUT	\$3211	\$3304	\$3343	\$3373	\$3433	\$3486	\$3640	\$3745	\$3876	\$4482	\$3452	\$5353	\$5696

COM/yds = 4¼, COL/sq ft = 94

Loveseat

473-2MAPLE	\$4168	\$4300	\$4354	\$4395	\$4485	\$4550	\$4761	\$4905	\$5079	\$5870	\$4409	\$6995	\$7451
473-2WALNUT	\$4262	\$4395	\$4448	\$4496	\$4579	\$4644	\$4855	\$4999	\$5178	\$5988	\$4487	\$7089	\$7550

COM/yds = 5¾, COL/sq ft = 127

▶ Specification Information, continued on next page

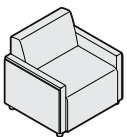

Overall: 29"D 28"W 30"H
 Inside: 20"D 22"W 13"H
 Seat: 17"H
 Arm: 22"H

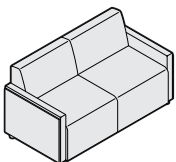

Overall: 29"D 54"W 30"H
 Inside: 20"D 48"W 13"H
 Seat: 17"H
 Arm: 22"H

Coupe Wood

DESIGN DENNIE PIMENTAL / JOHN DUFFY DESIGN ORIGIN: UNITED STATES

► Specification Information, continued from previous page

Specification Information

Style Number	U.S. Base Prices										Leather Grades:		
	Fabric Grades:										COL	C	E
	COM	6	7	8	9	10	11	12	13	14			

Sofa

473-3MAPLE	\$4895	\$5064	\$5134	\$5187	\$5287	\$5371	\$5624	\$5796	\$6018	\$6950	\$5144	\$8289	\$8851
473-3WALNUT	\$5024	\$5193	\$5258	\$5316	\$5411	\$5500	\$5754	\$5925	\$6147	\$7104	\$5267	\$8419	\$8980

COM/yds = 7, COL/sq ft = 154

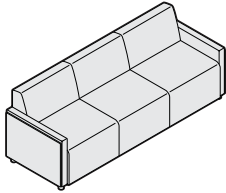

Overall: 29"D 74"W 30"H
 Inside: 20"D 67½"W 13"H
 Seat: 17"H
 Arm: 22"H



For Canadian Pricing
 Multiply U.S. Price by the
 Canadian price factor.
 ► See page 1 for details.

Davos by Viccarbe

DESIGN JEFFREY BERNETT DESIGN ORIGIN: 2006 SPAIN

Tip: For Customer's Own Material or Leather, see necessary requirements, important processing instructions, and ordering information
 ▶ See *Coalesse Surface Materials Reference Guide*.

Tip: Fabrics and leathers will appear loose with comfort wrinkles when upholstered.

▶ See page 135 for Multi-Fabric Diagram.

Tip: K suffix must be specified for leather underside.

Tip: Models with fabric underside include black denim section to allow for proper air flow. If this aesthetic is not desired, select contrasting option with leather underside.

Standard Includes Required to Specify

- Upholstery for chair or bench: fabric or leather

- 1 Style number
 - 2 Number of fabrics if contrasting fabric style number is selected
 - 3 Fabric or leather color number for upholstery
 - 4 Options, if selected (see below)
- ▶ See *Coalesse Surface Materials Reference Guide*.

Options U.S. Price Required to Specify

Surface Materials

- Contrasting Fabric

+\$113 per fabric

Add suffix **K** to the style number and select fabric color number.

Fire code seating

- CAL 133 for chair and small bench +\$218
- CAL 133 for medium and large bench +\$437

Specify with *CAL 133*.
 Specify with *CAL 133*.
 ▶ See *Coalesse Surface Materials Reference Guide*.

Acrylic backer

- Backer for chair +\$ 52
- Backer for large bench +\$ 31
- Backer for medium bench +\$ 23
- Backer for small bench +\$ 15

Specify with *acrylic backer*.
 Specify with *acrylic backer*.
 Specify with *acrylic backer*.
 Specify with *acrylic backer*.
 ▶ See *Coalesse Surface Materials Reference Guide*.

Specification Information

Style Number	U.S. Base Prices												Leather Grades:			
	Fabric Grades:												COL	C	E	
	COM	6	7	8	9	10	11	12	13	14						

Chair

CODAV	\$1867	\$1960	\$2001	\$2035	\$2099	\$2153	\$2316	\$2413	\$2630	\$2734	\$2083	\$3772	\$4058
-------	--------	--------	--------	--------	--------	--------	--------	--------	--------	--------	--------	--------	--------

COM/yds = 5, COL/sq ft = 110

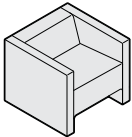

Overall: 30"D 30"W 25½"H
 Seat: 19"D 24"W 16½"H

Large Bench

CODAV60	\$1553	\$1595	\$1627	\$1650	\$1691	\$1726	\$1832	\$1891	\$2013	\$2149	\$1769	\$2751	\$2911
---------	--------	--------	--------	--------	--------	--------	--------	--------	--------	--------	--------	--------	--------

COM/yds = 3¼, COL/sq ft = 71½

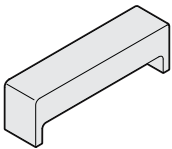

Overall: 13¼"D 59½"W 17½"H

Medium Bench

CODAV38	\$1120	\$1146	\$1169	\$1185	\$1218	\$1244	\$1326	\$1380	\$1514	\$1659	\$1336	\$2216	\$2359
---------	--------	--------	--------	--------	--------	--------	--------	--------	--------	--------	--------	--------	--------

COM/yds = 2½, COL/sq ft = 55

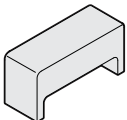

Overall: 13¼"D 38"W 17½"H

Small Bench

CODAV16	\$ 687	\$ 695	\$ 709	\$ 721	\$ 745	\$ 762	\$ 819	\$ 858	\$ 952	\$1111	\$ 903	\$1583	\$1709
---------	--------	--------	--------	--------	--------	--------	--------	--------	--------	--------	--------	--------	--------

COM/yds = 1¾, COL/sq ft = 39



Overall: 13¼"D 18½"W 17½"H

Davos Multi-Fabric Diagram

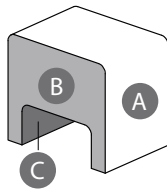
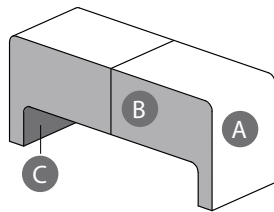
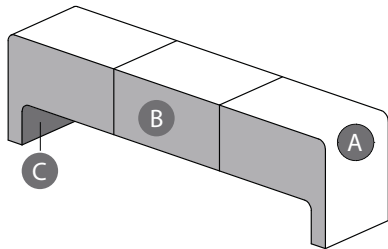
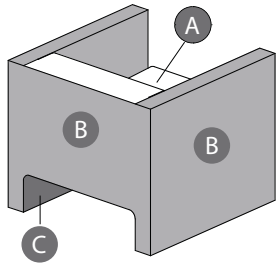
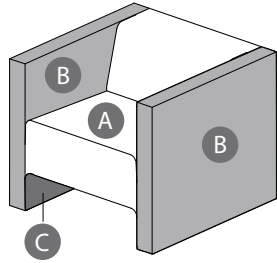

TO: _____

FROM: _____

DATE: _____

FAX...888.413.5161

Davos Chair

- A** Seat (upholstery selections default for entire unit if B is not selected): _____
- B** Arms and Back: _____
- C** Underside: _____

Davos Large Bench

- A** Seat (upholstery selections default for entire unit if B is not selected): _____
- B** Side: _____
- C** Underside: _____

Davos Medium Bench

- A** Seat (upholstery selections default for entire unit if B is not selected): _____
- B** Side: _____
- C** Underside: _____

Davos Small Bench

- A** Seat (upholstery selections default for entire unit if B is not selected): _____
- B** Side: _____
- C** Underside: _____

*\$113 list per contrasting fabric specified. List price based on highest grade textile specified.

**Highest grade pricing will not apply to C and E leathers when applied to the underside.

Detour

DESIGN METRO DESIGN GROUP | STEELCASE AND IDGO

Detour lounge seating offers a range of soft seating with embedded features that provide user control and personal comfort for informal work activities. Three lounge chair sizes are available – small lounge with a narrow back, small lounge with a wide back, and large lounge. An ottoman is also available.

Cast handle is integrated into the top of the back cushion. It is used to move or position the chair.

Back is fully upholstered. It flexes for user comfort.

Tablet arm is available. It pivots into position or can be moved out of the user's way.

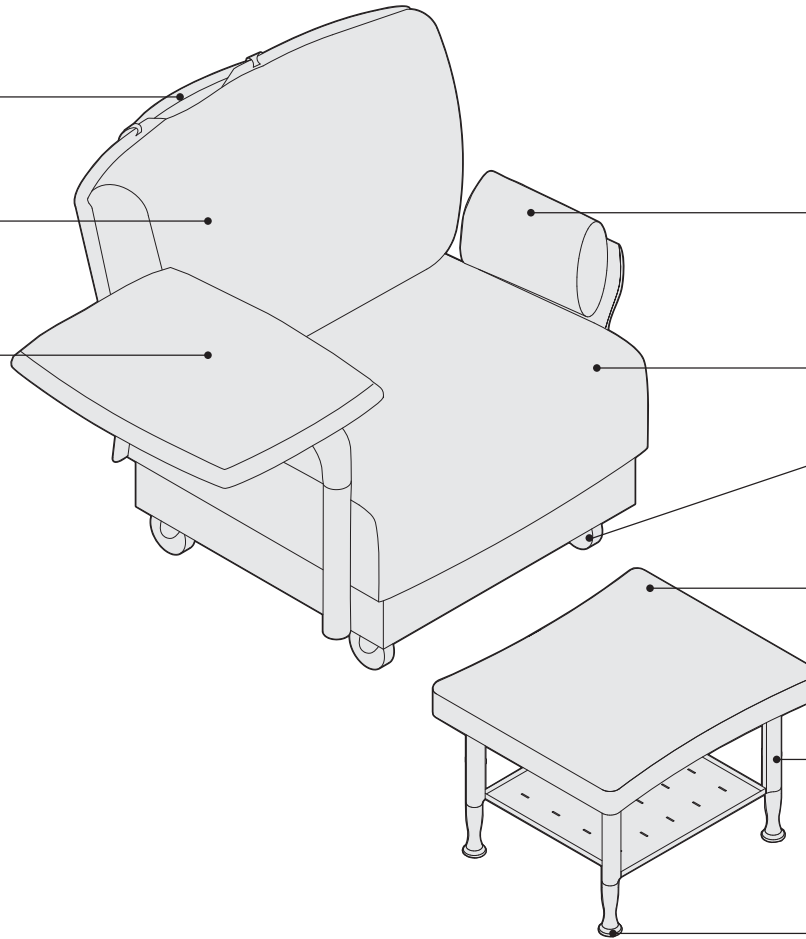

Arms are fully upholstered. They are available on the left, right, or both sides. An armless model is also available.

Seat is fully upholstered.

Soft casters provide ease of mobility. They are non-locking.

Ottoman can be used as a footrest, bench, or soft work-surface. An open shelf below the seat provides storage.

Legs are finished with paint.

Adjustable glides painted to match the legs with a black plastic bottom. Glides adjust $\frac{3}{4}$ ".

Actual dimensions
▶ See page 138

Detour

DESIGN METRO DESIGN GROUP | STEELCASE AND IDEO

Product Details

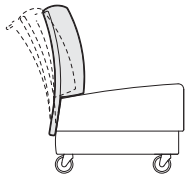

Flex-back allows the user to lean back with the concealed flex-back mechanism. The amount of recline resistance is directly proportional to the user's weight.

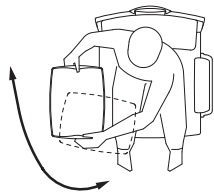

Tablet arm pivots into position or out of the way. The tablet arm is handed for use on the left- or right-hand side of the chair.



Ottoman is available with glides or casters. It is intended as a footrest. However, it also provides a backless seating option. It is equipped with a lower storage shelf.

Multiple fabrics can be specified on an individual unit for an additional fee per specified fabric. A lounge chair can have up to five additional fabrics.

Lounge chair

- Seat cushion (including sides of seat cushion) - no additional fee
- Back cushion (including sides of back cushion) - additional fee
- Base frame - additional fee
- Back frame (outside back panel) - additional fee
- Inside arms - no additional fee
- Outside arms - no additional fee

► See *Detour multi-fabric diagram and yardage request form*, page 145.

Connections

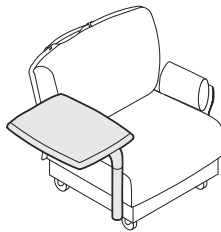

Tablet arm is handed. A right-hand tablet connects to the right side and a left-hand tablet connects to the left side while facing the chair. It may be attached on the same side as an arm. It is positioned in front and over the arm, so the movement isn't restricted.

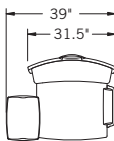
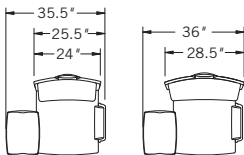

Overall width increases when a tablet arm is attached.

Surface Materials

Seat, inner back, outer back frame, base frame, inside arm, and outside arm, if selected

- Fabric

Tablet arm surface

- Laminate Grade 1
- Wood veneer

Support for tablet arm

- Paint

Cast handle

- Paint

Legs

- Paint

Glides

- Paint

Casters

- Paint

Ottoman lower storage shelf

- Paint

Note: Refer to the *Coalesse Surface Materials Reference Guide* for additional surface materials information.

Programs & Services

Fire code seating (FCS) modifications are available to meet CAL TB133 requirements. ► See *Coalesse Surface Materials Reference Guide*.

Customer's Own Material/Leather (COM/COL) program is available.

► See *Coalesse Surface Materials Reference Guide* for additional information.

Designers

Metro Design Group |
Steelcase & IDEO

Detour continued

DESIGN METRO DESIGN GROUP | STEELCASE AND IDEO

Actual Dimensions

	Overall Depth	Width	Height	Seat Depth	Width	Seat height from floor: at back, at front	Back height from seat at back	Back width	Arm height	Tablet height
Small lounge, narrow back without arms	29"	24"	31"	18½"	22"	16½"-front 14½"-back	16½"	21½"	n.a.	24½"
Small lounge, narrow back with one arm	29"	25½"	31"	18½"	22"	16½"-front 14½"-back	16½"	21½"	22½"	24½"
Small lounge, narrow back with two arms	29"	28½"	31"	18½"	22"	16½"-front 14½"-back	16½"	21½"	22½"	24½"
Small lounge, wide back <i>Tip: overall dimensions are the same for all models, regardless of the arm selection.</i>	29"	28½"	31"	18½"	22"	16½"-front 14½"-back	16½"	25¾"	22½"	24½"
Large lounge <i>Tip: overall dimensions are the same for all models, regardless of the arm selection.</i>	29"	28½"	31"	19½"	25"	16½"-front 14½"-back	16½"	28¾"	22½"	24½"
Small arm	14"	4"	22½"	N.A.	N.A.	N.A.	N.A.	N.A.	N.A.	N.A.
Large arm	15"	4"	22½"	N.A.	N.A.	N.A.	N.A.	N.A.	N.A.	N.A.
Tablet arm	16"	12"	24½" when attached	N.A.	N.A.	N.A.	N.A.	N.A.	N.A.	N.A.
Ottoman	20"	23"	16½"	N.A.	N.A.	N.A.	N.A.	N.A.	N.A.	N.A.

Coalesse

Detour

DESIGN METRO DESIGN GROUP | STEELCASE AND IDEO

Detour Lounge Chairs

DESIGN METRO DESIGN GROUP | STEELCASE AND IDEO

Tip: Begin a new series of line items for each chair configuration.

Tip: For veneer tops, edge and top will be the same finish color. For laminate tops, edge will always be black.

Tip: Fabrics and leathers will appear loose with comfort wrinkles when upholstered.

Tip: When specifying fabric in different price grades, the highest price grade prevails.

Tip: The COM yards and COL square footage listed on these pages reflect the requirements for a single fabric that are based on non-directional 54"W material applied railroaded. For multi-fabric COM requirements, please refer to multi-fabric yardage.
 ▶ Page 145

Tip: For Customer's Own Material or Leather, see necessary requirements, important processing instructions, and ordering information
 ▶ See Coalesse Surface Materials Reference Guide.

Tip: Tablet arm, if selected, should be entered on consecutive lines of the purchase order immediately following the lounge chair to which it will be applied. Components for identical chair configurations may be grouped together on consecutive lines.

Tip: Handedness is determined while facing the chair.



Standard Includes		Required to Specify	
▶ Need help? product details, page 136	<ul style="list-style-type: none"> Seat, inner back, outer back frame, base frame, inside and outside arms, if selected: fabric or leather Cast handle: paint Legs and adjustable glides, if selected: paint Casters, if selected: paint Tablet arm surface, if selected: laminate (Grade 1) or wood veneer Tablet arm support: paint 	<ol style="list-style-type: none"> Style number Number of fabrics if contrasting fabric style number is selected Fabric or leather color number for seat, inner back, outer back frame, base frame, inside and outside arms, if selected Paint color number for cast handle, legs, glides or casters, and tablet arm support, if selected Laminate or wood color number for tablet arm, if selected Options, if selected (see below) 	▶ See Coalesse Surface Materials Reference Guide.
Options		U.S. Price	Required to Specify
Surface Materials	<ul style="list-style-type: none"> Contrasting fabric 	+\$113 per fabric	Add suffix K to the style number and select fabric color number.
	Fire code seating		
	<ul style="list-style-type: none"> CAL 133 for lounge chair 	+\$218	Specify with CAL 133. ▶ See Coalesse Surface Materials Reference Guide.
	Acrylic backer		
	<ul style="list-style-type: none"> Backer for small lounge with narrow back and no arms Backer for small lounge with wide back and no arms Backer for large chair with no arms Backer for small lounge with narrow back and one arm Backer for small lounge with wide back and one arm Backer for large chair and one arm Backer for small lounge with narrow back and two arms Backer for small lounge with wide back and two arms Backer for large chair and two arms 	<ul style="list-style-type: none"> +\$ 31 +\$ 35 +\$ 44 +\$ 37 +\$ 42 +\$ 50 +\$ 44 +\$ 48 +\$ 56 	<ul style="list-style-type: none"> Specify with acrylic backer. Specify with acrylic backer. Specify with acrylic backer. Specify with acrylic backer. Specify with acrylic backer. Specify with acrylic backer. Specify with acrylic backer. Specify with acrylic backer. Specify with acrylic backer.
Related Products	<ul style="list-style-type: none"> Ottoman 		▶ page 144

Specification Information

Style Number	U.S. Base Prices												Leather Grades:		
	Fabric Grades:												COL	C	E
COM	6	7	8	9	10	11	12	13	14						

Small Lounge Chair with Narrow Back and No Arms

With Casters

1101C	\$2149	\$2252	\$2299	\$2334	\$2427	\$2477	\$2518	\$2610	\$2651	\$2849	\$2352	\$3413	\$3604
-------	--------	--------	--------	--------	--------	--------	--------	--------	--------	--------	--------	--------	--------

With Glides

1101G	\$2149	\$2252	\$2299	\$2334	\$2427	\$2477	\$2518	\$2610	\$2651	\$2849	\$2352	\$3413	\$3604
-------	--------	--------	--------	--------	--------	--------	--------	--------	--------	--------	--------	--------	--------

COM/yds = 3¼, COL/sq ft = 59

▶ Specification Information, continued on next page



For Canadian Pricing
 Multiply U.S. Price by the Canadian price factor.
 ▶ See page 1 for details.

Detour Lounge Chairs

DESIGN METRO DESIGN GROUP | STEELCASE AND IDEO

► Specification Information, continued from previous page

Specification Information

Style Number	U.S. Base Prices														Leather Grades:		
	Fabric Grades:														COL	C	E
	COM	6	7	8	9	10	11	12	13	14							



Small Lounge Chair with Narrow Back and Left Arm

With Casters

1101CAX	\$2630	\$2764	\$2824	\$2867	\$2980	\$3043	\$3094	\$3206	\$3258	\$3503	\$2882	\$4464	\$4756
---------	--------	--------	--------	--------	--------	--------	--------	--------	--------	--------	--------	--------	--------

With Glides

1101GAX	\$2630	\$2764	\$2824	\$2867	\$2980	\$3043	\$3094	\$3206	\$3258	\$3503	\$2882	\$4464	\$4756
---------	--------	--------	--------	--------	--------	--------	--------	--------	--------	--------	--------	--------	--------

COM/yds = 4, COL/sq ft = 80



Small Lounge Chair with Narrow Back and Right Arm

With Casters

1101CXA	\$2630	\$2764	\$2824	\$2867	\$2980	\$3043	\$3094	\$3206	\$3258	\$3503	\$2882	\$4464	\$4756
---------	--------	--------	--------	--------	--------	--------	--------	--------	--------	--------	--------	--------	--------

With Glides

1101GXA	\$2630	\$2764	\$2824	\$2867	\$2980	\$3043	\$3094	\$3206	\$3258	\$3503	\$2882	\$4464	\$4756
---------	--------	--------	--------	--------	--------	--------	--------	--------	--------	--------	--------	--------	--------

COM/yds = 4, COL/sq ft = 80



Small Lounge with Narrow Back and Two Arms

With Casters

1101CAA	\$3109	\$3266	\$3332	\$3381	\$3508	\$3578	\$3635	\$3762	\$3820	\$4095	\$3407	\$4943	\$5235
---------	--------	--------	--------	--------	--------	--------	--------	--------	--------	--------	--------	--------	--------

With Glides

1101GAA	\$3109	\$3266	\$3332	\$3381	\$3508	\$3578	\$3635	\$3762	\$3820	\$4095	\$3407	\$4943	\$5235
---------	--------	--------	--------	--------	--------	--------	--------	--------	--------	--------	--------	--------	--------

COM/yds = 4½, COL/sq ft = 90



Small Lounge Chair with Wide Back and No Arms

With Casters

1102C	\$2221	\$2345	\$2399	\$2442	\$2547	\$2605	\$2652	\$2758	\$2806	\$3036	\$2455	\$3779	\$4022
-------	--------	--------	--------	--------	--------	--------	--------	--------	--------	--------	--------	--------	--------

With Glides

1102G	\$2221	\$2345	\$2399	\$2442	\$2547	\$2605	\$2652	\$2758	\$2806	\$3036	\$2455	\$3779	\$4022
-------	--------	--------	--------	--------	--------	--------	--------	--------	--------	--------	--------	--------	--------

COM/yds = 3¾, COL/sq ft = 75

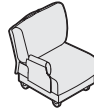

Small Lounge Chair with Wide Back and Left Arm

With Casters

1102CAX	\$2701	\$2848	\$2909	\$2957	\$3076	\$3141	\$3195	\$3316	\$3371	\$3631	\$2982	\$4443	\$4719
---------	--------	--------	--------	--------	--------	--------	--------	--------	--------	--------	--------	--------	--------

With Glides

1102GAX	\$2701	\$2848	\$2909	\$2957	\$3076	\$3141	\$3195	\$3316	\$3371	\$3631	\$2982	\$4443	\$4719
---------	--------	--------	--------	--------	--------	--------	--------	--------	--------	--------	--------	--------	--------

COM/yds = 4¼, COL/sq ft = 85



Small Lounge Chair with Wide Back and Right Arm

With Casters

1102CXA	\$2701	\$2848	\$2909	\$2957	\$3076	\$3141	\$3195	\$3316	\$3371	\$3631	\$2982	\$4443	\$4719
---------	--------	--------	--------	--------	--------	--------	--------	--------	--------	--------	--------	--------	--------

With Glides

1102GXA	\$2701	\$2848	\$2909	\$2957	\$3076	\$3141	\$3195	\$3316	\$3371	\$3631	\$2982	\$4443	\$4719
---------	--------	--------	--------	--------	--------	--------	--------	--------	--------	--------	--------	--------	--------

COM/yds = 4¼, COL/sq ft = 85



For Canadian Pricing
Multiply U.S. Price by the
Canadian price factor.

► See page 1 for details.

► Specification Information, continued on next page

Detour Lounge Chairs *continued*

DESIGN METRO DESIGN GROUP | STEELCASE AND IDEO

Tip: Handedness is determined while facing the chair.

Tip: Fabrics and leathers will appear loose with comfort wrinkles when upholstered.



► Specification Information, continued from previous page

Specification Information

Style Number	U.S. Base Prices										Leather Grades:		
	Fabric Grades:										COL	C	E
	COM	6	7	8	9	10	11	12	13	14			

Small Lounge Chair with Wide Back and Two Arms

With Casters

1102CAA	\$3184	\$3362	\$3436	\$3492	\$3632	\$3710	\$3772	\$3913	\$3977	\$4283	\$3512	\$5202	\$5527
---------	--------	--------	--------	--------	--------	--------	--------	--------	--------	--------	--------	--------	--------

With Glides

1102GAA	\$3184	\$3362	\$3436	\$3492	\$3632	\$3710	\$3772	\$3913	\$3977	\$4283	\$3512	\$5202	\$5527
---------	--------	--------	--------	--------	--------	--------	--------	--------	--------	--------	--------	--------	--------

COM/yds = 5, COL/sq ft = 100



Large Lounge Chair with No Arms

With Casters

1103C	\$2433	\$2590	\$2656	\$2705	\$2832	\$2902	\$2959	\$3086	\$3144	\$3419	\$2713	\$4267	\$4559
-------	--------	--------	--------	--------	--------	--------	--------	--------	--------	--------	--------	--------	--------

With Glides

1103G	\$2433	\$2590	\$2656	\$2705	\$2832	\$2902	\$2959	\$3086	\$3144	\$3419	\$2713	\$4267	\$4559
-------	--------	--------	--------	--------	--------	--------	--------	--------	--------	--------	--------	--------	--------

COM/yds = 4½, COL/sq ft = 90

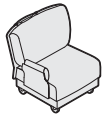

Large Lounge Chair with Left Arm

With Casters

1103CAX	\$2930	\$3087	\$3153	\$3202	\$3329	\$3399	\$3456	\$3583	\$3641	\$3916	\$3260	\$4764	\$5056
---------	--------	--------	--------	--------	--------	--------	--------	--------	--------	--------	--------	--------	--------

With Glides

1103GAX	\$2930	\$3087	\$3153	\$3202	\$3329	\$3399	\$3456	\$3583	\$3641	\$3916	\$3260	\$4764	\$5056
---------	--------	--------	--------	--------	--------	--------	--------	--------	--------	--------	--------	--------	--------

COM/yds = 4½, COL/sq ft = 90



Large Lounge Chair with Right Arm

With Casters

1103CXA	\$2930	\$3087	\$3153	\$3202	\$3329	\$3399	\$3456	\$3583	\$3641	\$3916	\$3260	\$4764	\$5056
---------	--------	--------	--------	--------	--------	--------	--------	--------	--------	--------	--------	--------	--------

With Glides

1103GXA	\$2930	\$3087	\$3153	\$3202	\$3329	\$3399	\$3456	\$3583	\$3641	\$3916	\$3260	\$4764	\$5056
---------	--------	--------	--------	--------	--------	--------	--------	--------	--------	--------	--------	--------	--------

COM/yds = 4½, COL/sq ft = 90

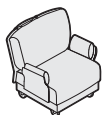

Large Lounge Chair with Two Arms

With Casters

1103CAA	\$3426	\$3615	\$3692	\$3750	\$3899	\$3980	\$4046	\$4195	\$4261	\$4582	\$3801	\$5535	\$5877
---------	--------	--------	--------	--------	--------	--------	--------	--------	--------	--------	--------	--------	--------

With Glides

1103GAA	\$3426	\$3615	\$3692	\$3750	\$3899	\$3980	\$4046	\$4195	\$4261	\$4582	\$3801	\$5535	\$5877
---------	--------	--------	--------	--------	--------	--------	--------	--------	--------	--------	--------	--------	--------

COM/yds = 5¼, COL/sq ft = 105

► Specification Information, continued on next page



For Canadian Pricing
 Multiply U.S. Price by the Canadian price factor.
 ► See page 1 for details.

Detour Lounge Chairs

DESIGN METRO DESIGN GROUP | STEELCASE AND IDEO

► Specification Information, continued from previous page

Specification Information

Dimensions			Style Number	U.S. Base Prices			
D	W	H		Lam 1	Lam 2	Wood 1	Wood 2

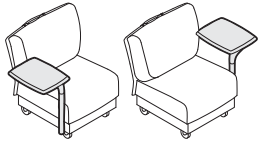

Tablet Arm

Left

16"	12"	24½"	1100TAL	\$574	\$603	\$639	\$662
-----	-----	------	---------	-------	-------	-------	-------

Right

16"	12"	24½"	1100TAR	\$574	\$603	\$639	\$662
-----	-----	------	---------	-------	-------	-------	-------



For Canadian Pricing
 Multiply U.S. Price by the
 Canadian price factor.
 ► See page 1 for details.

Detour Ottoman

DESIGN METRO DESIGN GROUP | STEELCASE AND IDEO



Tip: Ottoman with CAL TB133 option requires testing at the customer's expense.

Tip: The COM yards and COL square footage listed on this page reflect the requirements for a single fabric that are based on non-directional 54"W material applied railroaded.

Tip: For Customer's Own Material or Leather, see necessary requirements, important processing instructions, and ordering information
 ▶ See *Coalesse Surface Materials Reference Guide*.

Standard Includes		Required to Specify
▶ Need help? product details, page 136	<ul style="list-style-type: none"> • Seat: fabric or leather • Legs: paint • Lower storage shelf: paint • Adjustable glides, if selected: paint to match legs • Casters: paint to match legs 	1 Style number 2 Fabric or leather color number for seat 3 Paint color number for legs, lower storage shelf, glides or casters, if selected 4 Options, if selected (see below) ▶ See <i>Coalesse Surface Materials Reference Guide</i> .

Options	U.S. Price	Required to Specify
Surface Materials • Fire code seating • CAL 133 for ottoman	+\$113	Specify with CAL 133. ▶ See <i>Coalesse Surface Materials Reference Guide</i> .
• Acrylic backer • Backer	+\$ 10	Specify with acrylic backer. ▶ See <i>Coalesse Surface Materials Reference Guide</i> .
Related Products • Lounge chairs		▶ Page 140

Specification Information													
Style Number	U.S. Base Prices											Leather Grades:	
	Fabric Grades:											COL	C
	COM	6	7	8	9	10	11	12	13	14			

Ottoman

With Casters

1104C	\$829	\$845	\$863	\$878	\$911	\$932	\$948	\$983	\$999	\$1076	\$907	\$1431	\$1505
-------	-------	-------	-------	-------	-------	-------	-------	-------	-------	--------	-------	--------	--------

With Glides

1104G	\$829	\$845	\$863	\$878	\$911	\$932	\$948	\$983	\$999	\$1076	\$907	\$1431	\$1505
-------	-------	-------	-------	-------	-------	-------	-------	-------	-------	--------	-------	--------	--------

COM/yds = 1¼, COL/sq ft = 23



For Canadian Pricing
 Multiply U.S. Price by the Canadian price factor.
 ▶ See page 1 for details.

Detour Multi-Fabric Diagram and Yardage Request Form

DESIGN METRO DESIGN GROUP | STEELCASE AND IDEO

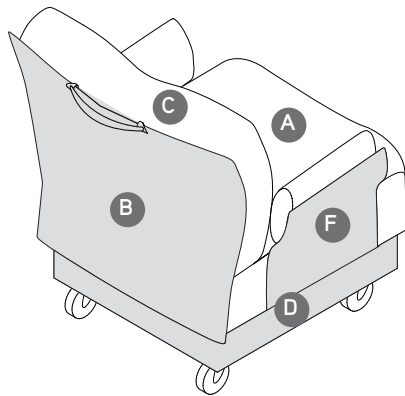
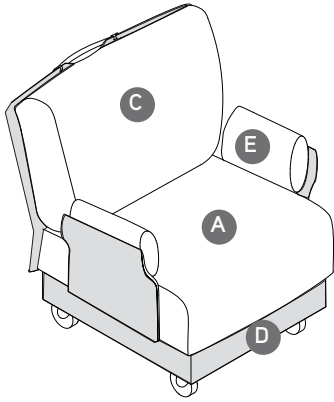

TO: _____

FROM: _____

DATE: _____

FAX...888.413.5161

Lounge Seating

A Seat (upholstery selections default for entire unit if B is not selected): _____

B Back: _____

C Back Cushion: _____

D Base Frame: _____

E Inner Arm: _____

F Outside Arm: _____

** \$113 U.S. list per contrasting fabric specified. List price based on highest fabric grade usage.*



For Canadian Pricing
Multiply U.S. Price by the
Canadian price factor.
▶ See page 1 for details.

Detour Multi-Fabric Yardage

DESIGN METRO DESIGN GROUP | STEELCASE AND IDEO

Multi-Fabric Yardage

Chair Model	Style Number	COM Yds*					
		Seat Cushion	Back Cushion	Outside Back Panel	Base Frame	Inside Arm(s)	Outside Arm(s)
Small lounge with casters, narrow back, no arms	1101C	1½	1	2	2½	N.A.	N.A.
Small lounge with glides, narrow back, no arms	1101G	1½	1	2	2½	N.A.	N.A.
Small lounge with casters, narrow back, arm left	1101CAX	1½	1	2	2½	½	½
Small lounge with glides, narrow back, arm left	1101GAX	1½	1	2	2½	½	½
Small lounge with casters, narrow back, arm right	1101CXA	1½	1	2	2½	½	½
Small lounge with glides, narrow back, arm right	1101GXA	1½	1	2	2½	½	½
Small lounge with casters, narrow back, two arms	1101CAA	1½	1	2	2½	1	1
Small lounge with glides, narrow back, two arms	1101GAA	1½	1	2	2½	1	1
Small lounge with casters, wide back, no arms	1102C	1½	1	2	2½	N.A.	N.A.
Small lounge with glides, wide back, no arms	1102G	1½	1	2	2½	N.A.	N.A.
Small lounge with casters, wide back, arm left	1102CAX	1½	1	2	2½	½	½
Small lounge with glides, wide back, arm left	1102GAX	1½	1	2	2½	½	½
Small lounge with casters, wide back, arm right	1102CXA	1½	1	2	2½	½	½
Small lounge with glides, wide back, arm right	1102GXA	1½	1	2	2½	½	½
Small lounge with casters, wide back, two arms	1102CAA	1½	1	2	2½	1	1
Small lounge with glides, wide back, two arms	1102GAA	1½	1	2	2½	1	1
Large lounge with casters	1103C	2	1¼	2	3	N.A.	N.A.
Large lounge with glides	1103G	2	1¼	2	3	N.A.	N.A.
Large lounge with casters, arm left	1103CAX	2	1¼	2	3	½	½
Large lounge with glides, arm left	1103GAX	2	1¼	2	3	½	½
Large lounge with casters, arm right	1103CXA	2	1¼	2	3	½	½
Large lounge with glides, arm right	1103GXA	2	1¼	2	3	½	½
Large lounge with casters, two arms	1103CAA	2	1¼	2	3	1	1
Large lounge with glides, two arms	1103GAA	2	1¼	2	3	1	1

*Fabric yardage is based on non-directional/solid fabrics. Use conversion chart on following page for repeat/printed fabric yardage.

Detour Multi-Fabric Yardage

DESIGN METRO DESIGN GROUP | STEELCASE AND IDEO

Non-standard fabric requirements

Yardage requirements shown are based on non-directional 54" w material applied railroaded. Coalesse will apply fabric railroaded unless instructed otherwise on the dealer's purchase order. The following conversion chart should be used to determine yardage requirements when COM has a repeat of 2" or more. Please contact Coalesse customer service for a yardage quotation if the fabric is less than 54" wide, has a repeat of more than 24", or if the fabric must be cut-right.

CONVERSION CHART

PRODUCT	REPEAT		
	2" - 8"	9" - 14"	15" - 24"
All other products	15%	25%	35%

Yardage quotations will also be provided for order of 10 or more pieces.

Cutting direction guidelines

Cutting direction is based on the fabric width and the way the fabric is cut from the roll and applied to Coalesse products. There are two cutting directions: railroaded or cut-right.

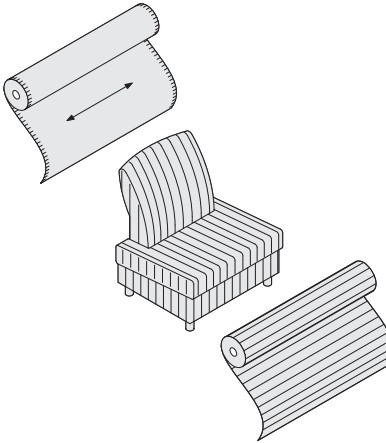

Horizontal or railroaded (across roll, warp horizontal) means fabric is cut across the roll; selvages are on the top and bottom.

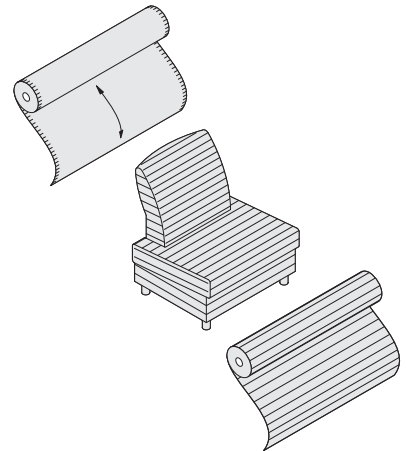

Vertical or cut-right (down roll, warp vertical) means fabric is cut in the same direction it is woven; selvages are on the left and right sides.

Coalesse reserves the right to railroad or apply fabric according to weave unless instructions specify otherwise. Fabrics are railroaded when possible to avoid seams in large upholstered areas and/or single cushion units. If a fabric is questionable, a cutting of adequate size showing full repeat (if any) should be sent to Coalesse for a fabric requirement quotation.

Donovan

DESIGN GEORGE SIMONS, IDSA DESIGN ORIGIN: UNITED STATES

Tip: Recommended leathers: are Tulsa Grade C or Dorado Grade E.

Tip: Special color match, consult customer service.

Tip: For Customer's Own Material or Leather, see necessary requirements, important processing instructions, and ordering information
▶ See *Coalesse Surface Materials Reference Guide*.

Tip: An additional 1/4 yard or 4 square feet required for contrasting buttons.

Tip: Fabrics and leathers will appear loose with comfort wrinkles when upholstered.

Standard Includes	Required to Specify
<ul style="list-style-type: none"> Chair or sofa: fabric or leather Frame: selected hardwood and hardwood veneer with carbon steel support rails Legs: solid maple Glides: non-adjustable Back pleat: black denim 	<ol style="list-style-type: none"> Style number Number of fabrics if contrasting fabric style number is selected Fabric or leather color number for seat, back, and fully upholstered arms Wood color number for legs ▶ See <i>Coalesse Surface Materials Reference Guide</i> . 5 Options, if selected (see below) ▶ See <i>Coalesse Surface Materials Reference Guide</i> .

Options	U.S. Price	Required to Specify
Surface Materials <ul style="list-style-type: none"> Contrasting fabric 	+\$113 per fabric	Add suffix K to the style number and select fabric color number.
Fire code seating <ul style="list-style-type: none"> CAL 133 for chair CAL 133 for two-seat sofa CAL 133 for three-seat sofa 	+\$218 +\$437 +\$568	Specify with CAL 133. Specify with CAL 133. Specify with CAL 133. ▶ See <i>Coalesse Surface Materials Reference Guide</i> .
Acrylic backer <ul style="list-style-type: none"> Backer for chair Backer for two-seat sofa Backer for three-seat sofa 	+\$ 39 +\$ 52 +\$ 69	Specify with acrylic backer. Specify with acrylic backer. Specify with acrylic backer. ▶ See <i>Coalesse Surface Materials Reference Guide</i> .
Back Pleat <ul style="list-style-type: none"> Coalesse fabric, leather, or Customer's Own Material (COM) 	+\$ 74	Specify with back pleat.
Buttons <ul style="list-style-type: none"> Contrasting 1 1/2" dia. on front and back 	+\$ 35	Specify with contrasting buttons.

Specification Information													
Style Number	U.S. Base Prices											Leather Grades:	
	Fabric Grades:											COL	C
	COM	6	7	8	9	10	11	12	13	14			

Chair													
356	\$1741	\$1979	\$1998	\$2033	\$2328	\$2588	\$2802	\$3008	\$3084	\$3163	\$2018	\$3351	\$3831
COM/yds = 4 1/2, COL/sq ft = 99													

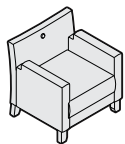

Overall: 25 3/4"D 30"W 31 1/4"H
 Inside: 18"D 21"W 13 3/4"H
 Seat: 17 3/4"H
 Arm: 24 1/2"H

Two-Seat Sofa													
356-2	\$3093	\$3421	\$3439	\$3485	\$3787	\$4118	\$4396	\$4626	\$4777	\$5009	\$3370	\$5188	\$5790
COM/yds = 5 3/4, COL/sq ft = 127													

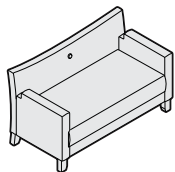

Overall: 25 3/4"D 55"W 31 1/4"H
 Inside: 18"D 46"W 13 3/4"H
 Seat: 17 3/4"H
 Arm: 24 1/2"H

▶ Specification Information, continued on next page



For Canadian Pricing
 Multiply U.S. Price by the Canadian price factor.
 ▶ See page 1 for details.

Donovan

DESIGN GEORGE SIMONS, IDSA DESIGN ORIGIN: UNITED STATES

► Specification Information, continued from previous page

Specification Information

Style Number	U.S. Base Prices										Leather Grades:		
	Fabric Grades:										COL	C	E
	COM	6	7	8	9	10	11	12	13	14			

Three-Seat Sofa

356-3	\$4142	\$4548	\$4583	\$4636	\$4997	\$5403	\$5747	\$6025	\$6230	\$6563	\$4420	\$6751	\$7435
-------	--------	--------	--------	--------	--------	--------	--------	--------	--------	--------	--------	--------	--------

COM/yds = 6½, COL/sq ft = 143

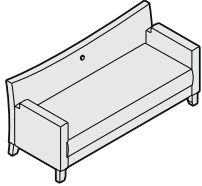

Overall: 25¾"D 70"W 31¼"H
 Inside: 18"D 61"W 13¾"H
 Seat: 17¾"H
 Arm: 24½"H



For Canadian Pricing
 Multiply U.S. Price by the
 Canadian price factor.
 ► See page 1 for details.

Evaneau

DESIGN LAUREN ROTTET DESIGN ORIGIN: UNITED STATES

Tip: Fabrics and leathers will appear loose with comfort wrinkles when upholstered.

Tip: Recommended leathers are Elmosoft Grade C and Elmorustical Grade E.

Tip: Special color match, consult customer service.

Tip: List price based on highest fabric grade.

Tip: All pillows and arm bolsters must be specified separately.

Tip: Four attachment straps required for 14-10L and 14-10R.

Tip: Seat and back cushions are standard as unattached. Attachment straps available as an option.

Tip: For Customer's Own Material or Leather, see necessary requirements, important processing instructions, and ordering information
 ▶ See *Coalesse Surface Materials Reference Guide*.

Standard Includes		Required to Specify	
	<ul style="list-style-type: none"> • Frame: selected hardwood • Legs: black powder coat • Upholstery: <ul style="list-style-type: none"> - Multiple densities of polyurethane foam and polyester fiber • Pillows, if selected: fabric or leather 		<ol style="list-style-type: none"> 1 Style number 2 Number of fabrics if contrasting fabric style number is selected 3 Fabric or leather color number for upholstery on seat and back or pillows, if selected 4 Options, if selected (see below) ▶ See <i>Coalesse Surface Materials Reference Guide</i> .
Options		U.S. Price	Required to Specify
Surface Materials	<ul style="list-style-type: none"> • Contrasting fabric 	+\$113 per fabric	Add suffix K to the style number and select fabric color number.
	Fire code seating		
	<ul style="list-style-type: none"> • CAL 133 for chair, single arm chair, and ottoman • CAL 133 for two-seat sofa • CAL 133 for three-seat sofa and asymmetrical • CAL 133 for pillow 	+\$218 +\$437 +\$568 +\$113	Specify with <i>CAL 133</i> . Specify with <i>CAL 133</i> . Specify with <i>CAL 133</i> . Specify with <i>CAL 133</i> . ▶ See <i>Coalesse Surface Materials Reference Guide</i> .
	Acrylic backer		
	<ul style="list-style-type: none"> • Backer for chair • Backer for single arm chair • Backer for asymmetrical chairs • Backer for two-seat sofa • Backer for three-seat sofa • Backer for low round ottomans • Backer for high ottomans • Backer for back and arm pillows 	+\$ 50 +\$ 42 +\$112 +\$ 73 +\$104 +\$ 21 +\$ 31 +\$ 8	Specify with <i>acrylic backer</i> . Specify with <i>acrylic backer</i> . Specify with <i>acrylic backer</i> . Specify with <i>acrylic backer</i> . Specify with <i>acrylic backer</i> . Specify with <i>acrylic backer</i> . Specify with <i>acrylic backer</i> . Specify with <i>acrylic backer</i> . ▶ See <i>Coalesse Surface Materials Reference Guide</i> .
Legs	<ul style="list-style-type: none"> • Plated: brushed carbon steel • Plated: brushed carbon steel (on 14-10R, 14-10L, or 14-30) 	+\$426 +\$636	Specify with <i>plated legs</i> . Specify with <i>plated legs</i> .
Attachment Straps	<ul style="list-style-type: none"> • Attachment straps • Pillow attachment straps 	+\$118 per cushion +\$ 59	Specify with <i>attachment straps</i> . Specify with <i>pillow attachment straps</i> .
Casters	<ul style="list-style-type: none"> • Dual wheel casters for ottoman 	+\$113	Specify with <i>dual wheel casters</i> .

Specification Information

Style Number	U.S. Base Prices														Leather Grades:		
	Fabric Grades:														COL	C	E
	COM	6	7	8	9	10	11	12	13	14							

Chair																	
14-C	\$2875	\$3114	\$3150	\$3217	\$3422	\$3660	\$3865	\$4053	\$4304	\$4581	\$3142	\$5223	\$5825				
COM/yds = 5½, COL/sq ft = 121																	

▶ Specification Information, continued on next page

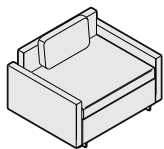

Overall: 34"D 42"W 29¾"H
 Inside: 22½"D 37"W 12½"H
 Seat: 17½"H
 Arm: 21"H

 **For Canadian Pricing**
 Multiply U.S. Price by the Canadian price factor.
 ▶ See page 1 for details.

Evaneau

DESIGN LAUREN ROTTET DESIGN ORIGIN: UNITED STATES

► Specification Information, continued from previous page

Specification Information

Style Number	U.S. Base Prices										Leather Grades:		
	Fabric Grades:										COL	C	E
	COM	6	7	8	9	10	11	12	13	14			

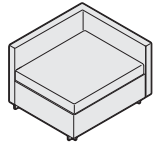

Overall: 30"D 30"W 26½"H
 Inside: 27½"D 27½"W 9"H
 Seat: 17½"H
 Arm: 26½"H

Single Arm Chair

14-5	\$2219	\$2386	\$2414	\$2453	\$2561	\$2738	\$2891	\$2994	\$3179	\$3399	\$2480	\$3994	\$ 4481
------	--------	--------	--------	--------	--------	--------	--------	--------	--------	--------	--------	--------	---------

COM/yds = 4, COL/sq ft = 88

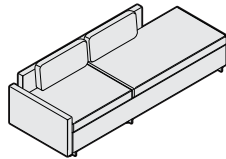

Overall: 44"D 95"W 29¾"H
 Inside: 22½"D 95½"W 12½"H
 Seat: 17½"H
 Arm: 21"H

Asymmetrical

Left-Arm Facing

14-10L	\$4983	\$5518	\$5592	\$5723	\$6029	\$6536	\$6962	\$7279	\$7686	\$8156	\$5244	\$9659	\$10,676
--------	--------	--------	--------	--------	--------	--------	--------	--------	--------	--------	--------	--------	----------

Right-Arm Facing

14-10R	\$4983	\$5518	\$5592	\$5723	\$6029	\$6536	\$6962	\$7279	\$7686	\$8156	\$5244	\$9659	\$10,676
--------	--------	--------	--------	--------	--------	--------	--------	--------	--------	--------	--------	--------	----------

COM/yds = 11½, COL/sq ft = 253

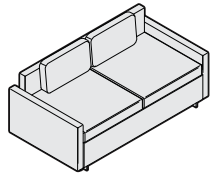

Overall: 34"D 66"W 29¾"H
 Inside: 22½"D 61"W 12½"H
 Seat: 17½"H
 Arm: 21"H

Two-Seat Sofa

14-20	\$4122	\$4504	\$4566	\$4657	\$4879	\$5260	\$5567	\$5811	\$6151	\$6551	\$4383	\$7629	\$ 8441
-------	--------	--------	--------	--------	--------	--------	--------	--------	--------	--------	--------	--------	---------

COM/yds = 8½, COL/sq ft = 187

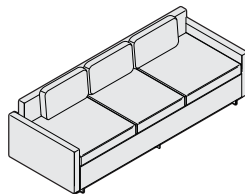

Overall: 34"D 90"W 29¾"H
 Inside: 22½"D 85"W 12½"H
 Seat: 17½"H
 Arm: 21"H

Three-Seat Sofa

14-30	\$5121	\$5628	\$5703	\$5833	\$6117	\$6612	\$7004	\$7322	\$7732	\$8227	\$5378	\$9605	\$10,582
-------	--------	--------	--------	--------	--------	--------	--------	--------	--------	--------	--------	--------	----------

COM/yds = 11, COL/sq ft = 242



Overall: 30"D 13½"H

Ottoman, Low Round

14-HLR	\$1279	\$1365	\$1388	\$1410	\$1480	\$1588	\$1684	\$1752	\$1855	\$1977	\$1540	\$2479	\$ 2849
--------	--------	--------	--------	--------	--------	--------	--------	--------	--------	--------	--------	--------	---------

COM/yds = 2½, COL/sq ft = 55



Overall: 30"D 17½"H

Ottoman, High Round

14-HHR	\$1531	\$1636	\$1669	\$1704	\$1778	\$1908	\$2015	\$2107	\$2224	\$2373	\$1793	\$2919	\$ 3328
--------	--------	--------	--------	--------	--------	--------	--------	--------	--------	--------	--------	--------	---------

COM/yds = 3, COL/sq ft = 66

► Specification Information, continued on next page

► Specification Information, continued from previous page

Specification Information

Style Number	U.S. Base Prices												Leather Grades:		
	Fabric Grades:												COL	C	E
	COM	6	7	8	9	10	11	12	13	14					

Ottoman, High Square

14-HHS	\$1531	\$1625	\$1652	\$1687	\$1755	\$1879	\$1976	\$2061	\$2173	\$2373	\$1793	\$2828	\$3231
--------	--------	--------	--------	--------	--------	--------	--------	--------	--------	--------	--------	--------	--------

COM/yds = 2¾, COL/sq ft = 61

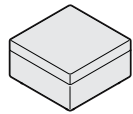

Overall: 30"D 17½"H



Overall: 12"D 3½" thick

12" Round Back Pillow

14-6	\$ 394	\$ 367	\$ 378	\$ 396	\$ 437	\$ 469	\$ 498	\$ 550	\$ 566	\$ 675	\$ 626	\$ 742	\$1010
------	--------	--------	--------	--------	--------	--------	--------	--------	--------	--------	--------	--------	--------

COM/yds = 1, COL/sq ft = 20

16" Round Back Pillow

14-7	\$ 417	\$ 401	\$ 408	\$ 430	\$ 460	\$ 497	\$ 527	\$ 567	\$ 600	\$ 719	\$ 655	\$ 970	\$1232
------	--------	--------	--------	--------	--------	--------	--------	--------	--------	--------	--------	--------	--------

COM/yds = 1, COL/sq ft = 20



Overall: 16"D 3½" thick

Arm Pillow

14-A	\$ 254	\$ 256	\$ 262	\$ 268	\$ 290	\$ 319	\$ 353	\$ 370	\$ 385	\$ 408	\$ 516	\$ 723	\$ 966
------	--------	--------	--------	--------	--------	--------	--------	--------	--------	--------	--------	--------	--------

COM/yds = ¾, COL/sq ft = 15



Overall: 22"D 11"W 2"H

Arm Bolster

14-B	\$ 254	\$ 256	\$ 262	\$ 268	\$ 290	\$ 319	\$ 353	\$ 370	\$ 385	\$ 408	\$ 516	\$ 723	\$ 966
------	--------	--------	--------	--------	--------	--------	--------	--------	--------	--------	--------	--------	--------

COM/yds = ¾, COL/sq ft = 15



Overall: 23"D 6"W 6"H



For Canadian Pricing
 Multiply U.S. Price by the
 Canadian price factor.
 ► See page 1 for details.

Evaneau Multi-Fabric Diagram

TO: _____

FROM: _____

DATE: _____

MODEL: _____

FAX....888.413.5161

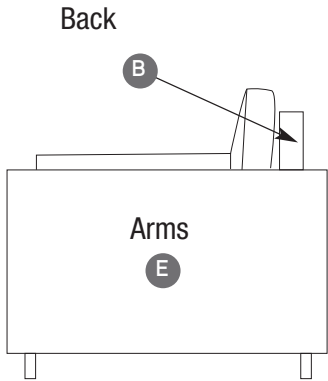

14-CK Chair

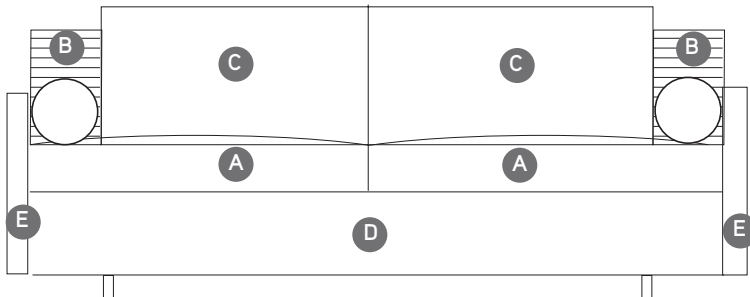
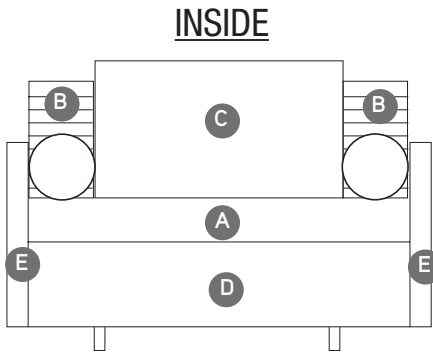

14-20K Two Seat Sofa

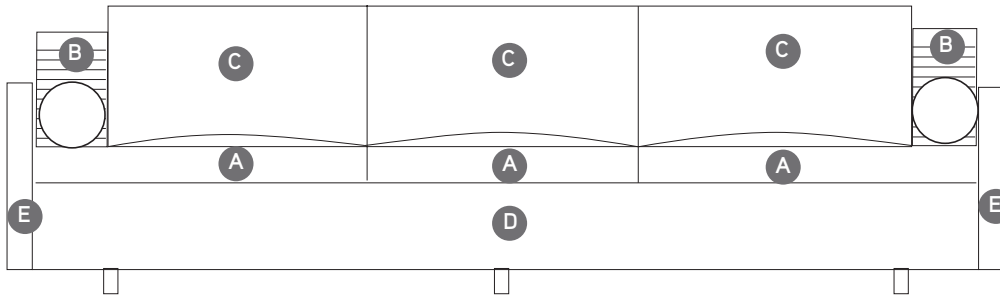

14-30 Three Seat Sofa

A Upholstery selections (default for entire unit if B is not selected): _____

B Back _____

C Back Cushion _____

D Base Frame _____

E Arms _____

Total List Price

Upcharge For Contrasting Fabrics = \$113

U.S. list per contrasting fabric specified.

List price based on highest grade textile specified.

Tip: All pillows and arm bolsters must be specified separately.

Herren

DESIGN CHRISTIAN HEIMBERGER DESIGN ORIGIN: GERMANY

Tip: Fabrics and leathers will appear loose with comfort wrinkles when upholstered.

Tip: All cushions are attached.

Tip: Recommended leathers are Elmosoft Grade C and Elmorustical Grade E.

Tip: Special color match, consult customer service.

Tip: For Customer's Own Material or Leather, see necessary requirements, important processing instructions, and ordering information
 ▶ See *Coalesse Surface Materials Reference Guide*.

Tip: Steelcase finishes available at no upcharge. Special match finishes are available.
 ▶ See *Coalesse Surface Materials Reference Guide*.

Standard Includes

- Frame: molded wood veneer and selected hardwood frame
- Upholstery: multiple densities of polyurethane foam and polyester fiber seat, back and arm cushions
- Base: solid maple 1 1/8" diameter non-adjustable metal glides

Required to Specify

- 1 Style number
 - 2 Number of fabrics if contrasting fabric style number is selected
 - 3 Fabric or leather color number for upholstery on seat and back
 - 4 Wood color number for legs and base
- ▶ See *Coalesse Surface Materials Reference Guide*.
 5 Options, if selected (see below)
 ▶ See *Coalesse Surface Materials Reference Guide*.

Options

Options	U.S. Price	Required to Specify
Surface Materials	• Contrasting fabric	+\$113 per fabric
		Add suffix K to the style number and select fabric color number.
		Specify with CAL 133.
		Specify with CAL 133.
		Specify with CAL 133.
		▶ See <i>Coalesse Surface Materials Reference Guide</i> .
		Specify with acrylic backer.
		Specify with acrylic backer.
		Specify with acrylic backer.
		▶ See <i>Coalesse Surface Materials Reference Guide</i> .

Specification Information

Style Number	U.S. Base Prices											Leather Grades:		
	Fabric Grades:											COL	C	E
	COM	6	7	8	9	10	11	12	13	14				

Chair

284	\$1917	\$1930	\$1987	\$2067	\$2231	\$2367	\$2498	\$2584	\$2641	\$2723	\$2173	\$3429	\$3833
-----	--------	--------	--------	--------	--------	--------	--------	--------	--------	--------	--------	--------	--------

COM/yds = 3 1/2, COL/sq ft = 77

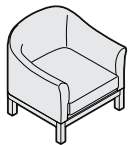

Overall: 30"D 32"W 31"H
 Inside: 20 3/4"D 21"W 14"H
 Seat: 17"H
 Arm: 26"H

Two-Seat Sofa

284-2	\$2787	\$3242	\$3333	\$3442	\$3589	\$3787	\$3982	\$4038	\$4060	\$4150	\$3048	\$5431	\$5923
-------	--------	--------	--------	--------	--------	--------	--------	--------	--------	--------	--------	--------	--------

COM/yds = 5, COL/sq ft = 110

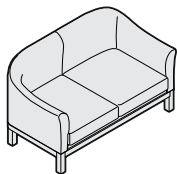

Overall: 30"D 56"W 31"H
 Inside: 20 3/4"D 45"W 14"H
 Seat: 17"H
 Arm: 26"H

Three-Seat Sofa

284-3	\$3340	\$3978	\$4091	\$4223	\$4415	\$4665	\$4921	\$4973	\$4985	\$5077	\$3602	\$6768	\$7341
-------	--------	--------	--------	--------	--------	--------	--------	--------	--------	--------	--------	--------	--------

COM/yds = 6, COL/sq ft = 132

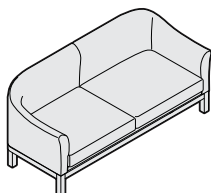

Overall: 30"D 72"W 31"H
 Inside: 20 3/4"D 61"W 14"H
 Seat: 17"H
 Arm: 26"H

Holy Day Lounge Chair by Viccarbe

DESIGN JEAN-MARIE MASSAUD DESIGN ORIGIN: 2003 SPAIN

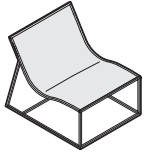

Overall: 30"D 27"W 26½"H
 Inside: 30½"D 27½"W 26½"H
 Seat: 15"H

Tip: Double needle stitch in matching color is standard for fabrics.

Tip: Saddle stitch in nine colors for leather.

Tip: For Customer's Own Material or Leather, see necessary requirements, important processing instructions, and ordering information
 ▶ See *Coalesse Surface Materials Reference Guide*.

Standard Includes	Required to Specify
-------------------	---------------------

<ul style="list-style-type: none"> Upholstery for chair: fabric or leather Glides Frame: polished trivalent chrome 	1 Style number 2 Fabric or leather color number for upholstery 3 Options, if selected (see below) ▶ See <i>Coalesse Surface Materials Reference Guide</i> .
---	--

Options	U.S. Price	Required to Specify
---------	------------	---------------------

Surface Materials <ul style="list-style-type: none"> Leather 	Prices below	Add suffix L to style number and specify leather color number.
Acrylic backer <ul style="list-style-type: none"> Backer for upholstered chair only 	+\$17	Specify with acrylic backer. ▶ See <i>Coalesse Surface Materials Reference Guide</i> .
Contrasting Saddle Stitching <ul style="list-style-type: none"> Available on leather only 	No cost	Specify with contrasting saddle stitching and select thread color.

Specification Information

Style Number	U.S. Prices											Leather Grades:		
	Fabric Grades:											COL	C	E
	COM	6	7	8	9	10	11	12	13	14				
COHD	\$2797	\$2811	\$2828	\$2842	\$2867	\$2890	\$2954	\$2998	\$3091	\$3210	N.A.	N.A.	N.A.	
COHDL	N.A.	N.A.	N.A.	N.A.	N.A.	N.A.	N.A.	N.A.	N.A.	N.A.	\$3013	\$3785	\$3927	

COM/yds = 2, COL/sq ft = 44

Lounge Seating



For Canadian Pricing
 Multiply U.S. Price by the Canadian price factor.
 ▶ See page 1 for details.

Hosu

DESIGN PATRICIA URQUIOLA DESIGN ORIGIN: SPAIN

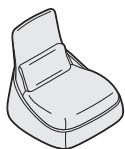

Tip: Fabrics and leathers will appear loose with comfort wrinkles when upholstered.

Tip: Recommended leathers are Elmosoft Grade C and Elmorustical Grade E.

Tip: If fabric is selected on models with ottoman, foot rest is available with Fusion fabric CL60 Caviar only. If leather is selected, the foot rest will match leather specified on seat and back.

Tip: Frame design allows back to flex to support occupants back shape.

Tip: Due to the design and construction techniques of the Hosu lounge and sofa only certain textiles can be successfully applied, therefore all COM fabrics must be submitted to Coalesse for approval prior to order acceptance.

Tip: Hexa fabrics (fabric group 10) were specifically designed by Patricia Urquiola for Hosu lounge and sofa seating.
 ► See *Coalesse Surface Materials Reference Guide* for complete listing of Hexa fabrics.

Tip: Hexa fabrics are not available with fire code seating.

Standard Includes	Required to Specify
<ul style="list-style-type: none"> • Frame: plywood tab construction • Multiple densities of polyurethane foam and polyester fiber • Seat and back: fabric or leather • Wrap: made from ABS plastic • Footrest on fabric chair, if selected: Fusion fabric only • Footrest on leather chair, if selected: leather to match seat and back • Glides: non-adjustable • Pull tab on ottoman, if selected: Fusion • Grommet for wire pass-through on models COURQLO and COURQLOK, if selected • Pillow: fabric or leather 	<ol style="list-style-type: none"> 1 Style number 2 Number of fabrics if contrasting fabric style number is selected 3 Fabric or leather color number for upholstery on seat, back, and pillow 4 Fusion color number for footrest, if selected: CL62 Graphite, CL63 Java 5 Fusion color number for pull tab, if selected: CL40 Red, CL41 Blue, CL42 Black 6 Options, if selected (see below) ► See <i>Coalesse Surface Materials Reference Guide</i> .

Options	U.S. Price	Required to Specify
Surface Materials		
Pillow for lounge chair and lounge chair with ottoman		
<ul style="list-style-type: none"> • Fabric groups 6-10 • Fabric group 11 • Fabric group 12 • Fabric group 13 • Fabric group 14 • Fabric group C • Fabric group E • Customer's Own Material (COM) 	No cost +\$103 +\$ 112 +\$153 +\$209 +\$355 +\$393 +\$ 38	Specify fabric color number. Specify fabric color number. Specify fabric color number. Specify fabric color number. Specify fabric color number. Specify fabric color number. Specify fabric color number. ► See <i>Coalesse Surface Materials Reference Guide</i> to specify ► See <i>Coalesse Surface Materials Reference Guide</i> to specify
<ul style="list-style-type: none"> • Customer's Own Leather (COL) 	+\$254	
Pillows for two-seat sofa		
<ul style="list-style-type: none"> • Fabric groups 6-10 • Fabric group 11 • Fabric group 12 • Fabric group 13 • Fabric group 14 • Fabric group C • Fabric group E • Customer's Own Material (COM) 	No cost +\$180 +\$195 +\$268 +\$366 +\$630 +\$696 +\$ 38	Specify fabric color number. Specify fabric color number. Specify fabric color number. Specify fabric color number. Specify fabric color number. Specify fabric color number. Specify fabric color number. ► See <i>Coalesse Surface Materials Reference Guide</i> to specify ► See <i>Coalesse Surface Materials Reference Guide</i> to specify
<ul style="list-style-type: none"> • Customer's Own Leather (COL) 	+\$254	
<ul style="list-style-type: none"> • Contrasting fabric 	+\$113 per fabric	Add suffix K to the style number and select fabric color number.
Fire code seating		
<ul style="list-style-type: none"> • CAL 133 for lounge chair • CAL 133 for lounge chair with ottoman • CAL 133 for two-seat sofa 	+\$269 +\$539 +\$723	Specify with <i>CAL 133</i> . Specify with <i>CAL 133</i> . Specify with <i>CAL 133</i> .
Acrylic backer		
<ul style="list-style-type: none"> • Backer for lounge chair • Backer for lounge chair with ottoman • Backer for two-seat sofa 	+\$ 39 +\$ 52 +\$ 69	Specify with <i>acrylic backer</i> . Specify with <i>acrylic backer</i> . Specify with <i>acrylic backer</i> . ► See <i>Coalesse Surface Materials Reference Guide</i> .

 **For Canadian Pricing**
 Multiply U.S. Price by the Canadian price factor.
 ► See page 1 for details.

Hosu

DESIGN PATRICIA URQUIOLA DESIGN ORIGIN: SPAIN

Specification Information

Style Number	U.S. Base Prices												
	Fabric Grades:												
	COM	6	7	8	9	10	11	12	13	14	COL	C	E

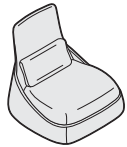

Overall: 35³/₈"D 34³/₈"W 35"H
 Inside: 24"D 31"W 14"H
 Pillow: 3"D 20⁹/₁₆"W 10¹/₈"H

Lounge with Lumbar Pillow

COURQL	\$2038	\$2101	\$2156	\$2203	\$2310	\$2393	\$2447	\$2485	\$2665	\$2909	\$2254	\$3551	\$3715
--------	--------	--------	--------	--------	--------	--------	--------	--------	--------	--------	--------	--------	--------

Lounge: COM/yds = 4¹/₄, COL/sq ft = 94
 Pillow: COM/yds = 1, COL/sq ft = 22

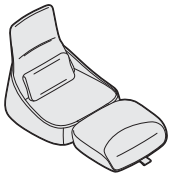

Overall: 35³/₈"D 34³/₈"W 35"H
 Overall extended: 57"L
 Inside: 24"D 31"W 14"H
 Inside extended: 48"L
 Pillow: 3"D 20⁹/₁₆"W 10¹/₈"H
 Ottoman: 24"D 31"W 8¹/₂"H

Lounge With Ottoman and Lumbar Pillow

COURQLO	\$2438	\$2536	\$2611	\$2675	\$2820	\$2932	\$3005	\$3057	\$3299	\$3629	\$2654	\$4479	\$4699
---------	--------	--------	--------	--------	--------	--------	--------	--------	--------	--------	--------	--------	--------

Lounge: COM/yds = 5³/₄, COL/sq ft = 126
 Pillow: COM/yds = 1, COL/sq ft = 22

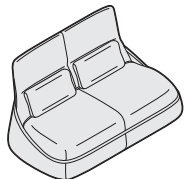

Overall: 35³/₈"D 64¹/₈"W 35"H
 Inside: 24"D 57¹/₈"W 14"H
 Pillows: 3"D 24"W 10¹/₈"H

Two-Seat Sofa with Two Lumbar Pillows

COURQS	\$3238	\$3360	\$3448	\$3523	\$3693	\$3824	\$3910	\$3971	\$4256	\$4643	\$3454	\$5560	\$5809
--------	--------	--------	--------	--------	--------	--------	--------	--------	--------	--------	--------	--------	--------

Sofa: COM/yds = 6³/₄, COL/sq ft = 143
 Pillows: COM/yds = 1³/₄, COL/sq ft = 39



For Canadian Pricing
 Multiply U.S. Price by the
 Canadian price factor.
 ▶ See page 1 for details.

Hosu Lounge Chair with Ottoman

DESIGN PATRICIA URQUIOLA DESIGN ORIGIN: SPAIN

TO: _____

FROM: _____

DATE: _____

FAX....888.413.5161

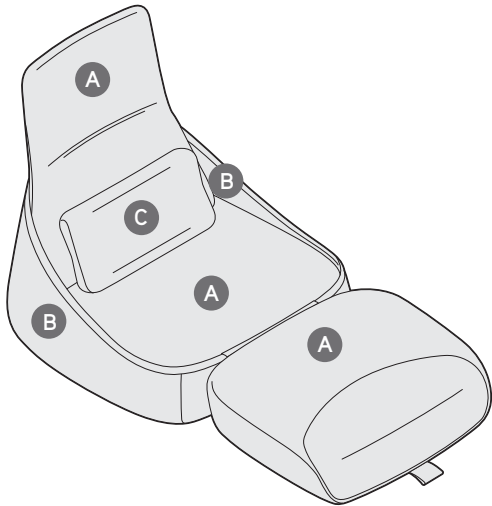

A Seat & back: _____

B Wrap: _____

C Pillow: _____

Contrasting fabric charges will apply. List price based on highest grade textile specified.

Specify Model below:

COURQLK Lounge Chair

COURQLOK Lounge Chair with Ottoman

COURQSK Two-Seat Sofa

Footrest is standard in Fusion caviar if fabric is specified on the chair. If leather is specified on the chair, leather on footrest will match.

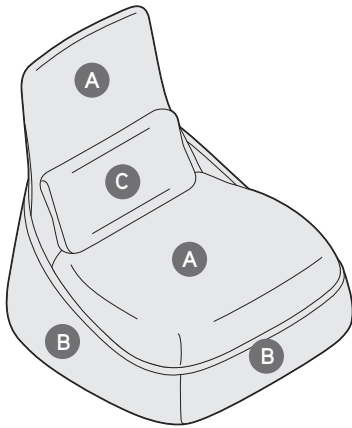

For Canadian Pricing
Multiply U.S. Price by the
Canadian price factor.
▶ See page 1 for details.

Coalesse

Joel Lounge by Walter Knoll

DESIGN EOOS DESIGN ORIGIN: 2004 GERMANY

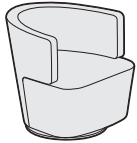

Overall: 29"D 30 1/4"W 27 1/2"H
 Seat: 16 1/4"H
 Arm: 26 1/4"H
 Inside: 21 1/2"D x 16 1/2" - 23"W x 11"H

Tip: Fabrics and leathers will appear loose with comfort wrinkles when upholstered.

Tip: For Customer's Own Material or Leather, see necessary requirements, important processing instructions, and ordering information
 ▶ See *Coalesse Surface Materials Reference Guide*.

Standard Includes	Required to Specify
-------------------	---------------------

- | | |
|---|--|
| <ul style="list-style-type: none"> • Base frame: steel with molded rigid foam • Seat frame: plywood with molded foam • Base: chrome plated steel • Auto swivel return mechanism | 1 Style number
2 Number of fabrics if contrasting fabric style number is selected
3 Fabric or leather color number for upholstery
4 Options, if selected (see below)
▶ See <i>Coalesse Surface Materials Reference Guide</i> . |
|---|--|

Options	U.S. Price	Required to Specify
---------	------------	---------------------

Surface Materials	<ul style="list-style-type: none"> • Contrasting Fabric 	+\$113 per fabric Add suffix K to the style number and select fabric color number.
	<ul style="list-style-type: none"> • Fire code seating • CAL 133 	+\$218 Specify with CAL 133. ▶ See <i>Coalesse Surface Materials Reference Guide</i> .
	<ul style="list-style-type: none"> • Acrylic backer • Backer 	+\$ 31 Specify with acrylic backer. ▶ See <i>Coalesse Surface Materials Reference Guide</i> .

Specification Information

Style Number	U.S. Base Prices													
	Fabric Grades:											Leather Grades:		
	COM	6	7	8	9	10	11	12	13	14	COL	C	E	
COWK100	\$1767	\$1820	\$1849	\$1873	\$1919	\$1955	\$2071	\$2145	\$2311	\$2518	\$1983	\$3361	\$3612	

COM/yds = 3 1/2, COL/sq ft = 77

Lounge Seating



For Canadian Pricing
 Multiply U.S. Price by the Canadian price factor.
 ▶ See page 1 for details.

Coalesse

Joel Lounge Multi-Fabric Diagram

DESIGN EOOS DESIGN ORIGIN: 2004 GERMANY

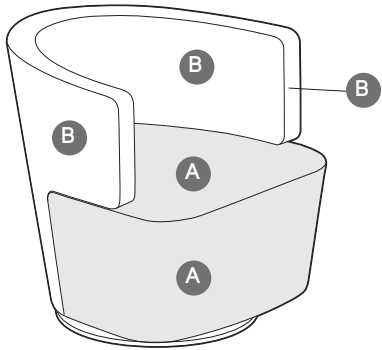

TO: _____

FROM: _____

DATE: _____

FAX....888.413.5161

A Seat (upholstery selections default for entire unit if B is not selected): _____

B Back: _____

** \$113 U.S. list upcharge for each contrasting textile pricing based on highest grade textile specified.*



For Canadian Pricing
Multiply U.S. Price by the
Canadian price factor.
▶ See page 1 for details.

Coalesse

Joel Lounge Multi-Fabric Diagram

DESIGN EOOS DESIGN ORIGIN: 2004 GERMANY

Massaud

Tip: Upholstery intent is loose to provide visual and inviting comfort.

Tip: Headrest is articulated to adjust forward and back 2¾" to accommodate support needs. Headrest contains removeable pillow to allow reorientation and differing heights.

Tip: Base swivels with automatic return to center position.

Standard Includes	Required to Specify
-------------------	---------------------

- Base: paint
- Inner and outer seat: fabric or leather
- Arm caps: fabric or leather
- Work lounge tablet, if selected: Fusion fabric only
- Work lounge tablet lever, if selected: painted to match base
- Removable pillow: fabric or leather to match outer seat
- Ottoman, if selected: fabric or leather
- Pull tab on ottoman, if selected: paint

- 1 Style number
 - 2 Number of fabrics if contrasting fabric style number is selected
 - 3 Paint color number for base
 - 4 Fabric or leather color number for inner and outer seat, and arm caps
 - 5 Fusion color number for work lounge tablet, if selected:
CL60 Caviar
CL61 Portobello
CL62 Graphite
CL63 Java
CL64 Steam
 - 6 Fabric or leather color number for ottoman, if selected
 - 7 Paint color number for pull tab on ottoman, if selected
 - 8 Options, if selected (see below)
- See *Coalesse Surface Materials Reference Guide*.

	Options	U.S. Price	Required to Specify
--	---------	------------	---------------------

Surface Materials	• Contrasting fabric	+\$113 per fabric	Add suffix K to the style number and select fabric color number. ► See <i>Coalesse Surface Materials Reference Guide</i> .
	Acrylic backer		
	• Backer for lounge and work lounge	+\$ 40	Specify with acrylic backer.
	• Backer for ottoman	+\$ 20	Specify with acrylic backer.

Specification Information

Style Number	U.S. Base Prices														Leather Grades:		
	Fabric Grades:														COL	C	E
COM	6	7	8	9	10	11	12	13	14								

Lounge Chair

COMCLG	\$3401	\$3401	\$3430	\$3478	\$3628	\$3724	\$3836	\$3914	\$4052	\$4244	\$3504	\$4686	\$4938
--------	--------	--------	--------	--------	--------	--------	--------	--------	--------	--------	--------	--------	--------

Work Lounge Chair

COMCWL	\$4060	\$4060	\$4091	\$4143	\$4301	\$4404	\$4523	\$4605	\$4752	\$4956	\$4154	\$5418	\$5684
--------	--------	--------	--------	--------	--------	--------	--------	--------	--------	--------	--------	--------	--------

► Specification information, continued on next page

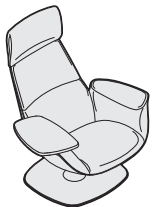

Tip: Work lounge tablet is always located on the right side of user when in seated position. Tablet is standard with pivot to allow tablet position to be closer to user.

Tip: Tablet has 2"H adjustability. To increase height, pull tablet. To decrease height, push lever forward and press tablet.

Massaud

► Specification information, continued from previous page

Specification Information

Style Number	U.S. Base Prices											Leather Grades:		
	Fabric Grades:											COL	C	E
	COM	6	7	8	9	10	11	12	13	14				

Ottoman

COMCOT	\$1190	\$1244	\$1262	\$1293	\$1386	\$1446	\$1516	\$1565	\$1651	\$1771	\$1404	\$2048	\$2205
--------	--------	--------	--------	--------	--------	--------	--------	--------	--------	--------	--------	--------	--------



Tip: Ottoman is standard with one space divider and bottom insert. Divider and bottom insert are available in 3224 Charcoal only.

Tip: Ottoman is standard with Coalesse imprinted on pull and a left- and right-hand storage pocket.

Tip: Ottoman is not available in contrasting fabrics.



For Canadian Pricing
 Multiply U.S. Price by the Canadian price factor.
 ► See page 1 for details.

Massaud

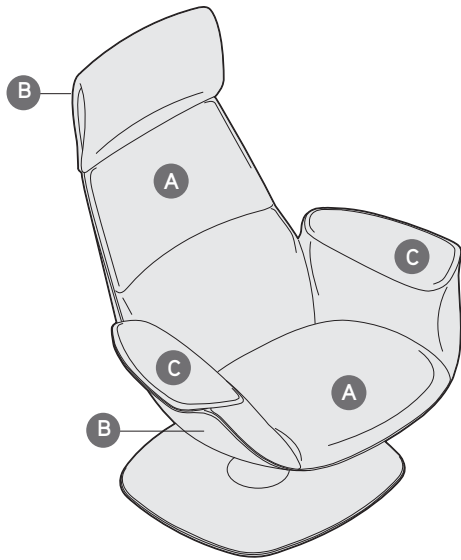

TO: _____

FROM: _____

DATE: _____

FAX....888.413.5161

A Inner seat _____

B Outer Seat: _____

C Arm cap: _____

Contrasting fabric charges will apply. List price based on highest grade textile specified.

Specify Model below:

COMCLGK Lounge Chair

COMCWLK Work Lounge Chair

Tip: Ottoman is not available in contrasting fabrics.

Coalesse

Massaud

Millbrae Lounge

DESIGN COALESSE DESIGN STUDIO DESIGN ORIGIN: USA

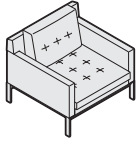

Tip: Fabrics and leathers will appear loose with comfort wrinkles when upholstered.

Tip: For Customer's Own Material or Leather, see necessary requirements, important processing instructions, and ordering information
 ▶ See *Coalesse Surface Materials Reference Guide*.

Standard Includes	Required to Specify
-------------------	---------------------

- Frame: constructed with finger jointed plywood
- Steel 1/2" x 1 3/4" legs
- Multiple densities of polyurethane foams and polyester fiber on seat and back: fabric or leather
- The lifestyle collection has tufted pattern accents and separate back cushions with double needle top stitch: fabric or leather
- The contract collection has quilted pattern accents with double needle top stitch: fabric or leather
- Leg finishes: black gloss
- Ganging kit with attachment hardware, if selected

- 1 Style number
 - 2 Fabric or leather color number for seat, back, and arms
 - 3 Options, if selected (see below)
- ▶ See *Coalesse Surface Materials Reference Guide*.

Surface Materials	Options	U.S. Price	Required to Specify
-------------------	---------	------------	---------------------

- | | | | |
|-------------------|----------------------|-------------------|---|
| Surface Materials | • Contrasting fabric | +\$113 per fabric | Add suffix K to the style number and select fabric color number.
▶ See <i>Coalesse Surface Materials Reference Guide</i> . |
|-------------------|----------------------|-------------------|---|

Fire Code Seating

- | | | |
|--|--------|--|
| • CAL 133 for lounge chair and one-seat bench | +\$218 | Specify with CAL 133. |
| • CAL 133 for two-seat sofa and two-seat bench | +\$437 | Specify with CAL 133. |
| • CAL 133 for three-seat sofa and three-seat bench | +\$568 | Specify with CAL 133. |
| • CAL 133 for four-seat sofa and four-seat bench | +\$681 | Specify with CAL 133. |
| • CAL 133 for square or round bolster pillow | +\$113 | Specify with CAL 133.
▶ See <i>Coalesse Surface Materials Reference Guide</i> . |

Acrylic backer

Lifestyle chairs

- | | | |
|------------------------------|--------|---|
| • Backer for lounge chair | +\$ 54 | Specify with acrylic backer. |
| • Backer for two-seat sofa | +\$ 89 | Specify with acrylic backer. |
| • Backer for three-seat sofa | +\$123 | Specify with acrylic backer.
▶ See <i>Coalesse Surface Materials Reference Guide</i> . |

Contract chairs

- | | | |
|---|--------|---|
| • Backer for lounge chair armless | +\$ 21 | Specify with acrylic backer. |
| • Backer for lounge chair with arms | +\$ 35 | Specify with acrylic backer. |
| • Backer for lounge chair left or right arm facing | +\$ 29 | Specify with acrylic backer. |
| • Backer for two-seat sofa armless | +\$ 35 | Specify with acrylic backer. |
| • Backer for two-seat sofa with arms | +\$ 48 | Specify with acrylic backer. |
| • Backer for two-seat sofa left or right arm facing | +\$ 42 | Specify with acrylic backer. |
| • Backer for three-seat sofa armless | +\$ 48 | Specify with acrylic backer. |
| • Backer for three-seat sofa with arms | +\$ 60 | Specify with acrylic backer. |
| • Backer for three-seat sofa left or right arm facing | +\$ 54 | Specify with acrylic backer. |
| • Backer for four-seat sofa armless | +\$ 60 | Specify with acrylic backer. |
| • Backer for four-seat sofa with arms | +\$ 73 | Specify with acrylic backer. |
| • Backer for four-seat sofa left or right arm facing | +\$ 66 | Specify with acrylic backer. |
| • Backer for bench | +\$ 15 | Specify with acrylic backer. |
| • Backer for two-seat bench | +\$ 21 | Specify with acrylic backer. |
| • Backer for three-seat bench | +\$ 29 | Specify with acrylic backer. |
| • Backer for four-seat bench | +\$ 35 | Specify with acrylic backer.
▶ See <i>Coalesse Surface Materials Reference Guide</i> . |

Bolsters

- | | | |
|--|-------|---|
| • Backer for square or round bolster pillows | +\$ 8 | Specify with acrylic backer.
▶ See <i>Coalesse Surface Materials Reference Guide</i> . |
|--|-------|---|

▶ Options, continued on next page



For Canadian Pricing
 Multiply U.S. Price by the Canadian price factor.
 ▶ See page 1 for details.

Millbrae Lounge

DESIGN COALESSE DESIGN STUDIO DESIGN ORIGIN: USA

► Options, continued from previous page

Options		U.S. Price	Required to Specify
Surface Materials	Legs		
	• Brushed nickel for lounge chair	+\$166	Specify with plated metal.
	• Brushed nickel for two-seat sofa	+\$228	Specify with plated metal.
	• Brushed nickel for three-seat sofa	+\$281	Specify with plated metal.
	• Brushed nickel for four-seat sofa	+\$333	Specify with plated metal.
	• Brushed nickel for one-seat bench	+\$166	Specify with plated metal.
	• Brushed nickel for two-seat bench	+\$228	Specify with plated metal.
	• Brushed nickel for three-seat bench	+\$281	Specify with plated metal.
	• Brushed nickel for four-seat bench	+\$333	Specify with plated metal.
Attachment Straps for Bolsters	• Attachment straps for left and right sides	+\$ 59	Specify with attachment straps for left and right sides.

Tip: Attachment straps are standard on back pillow of lifestyle chairs.

Specification Information

Style Number	U.S. Base Prices										Leather Grades:		
	Fabric Grades:										COL	C	E
	COM	6	7	8	9	10	11	12	13	14			

Lifestyle Chairs

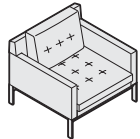

Overall: 35"D 35"W 28¾"H
Overall inside: 29"D 29"W 17"H
Inside to pillow: 22"D 29"W 17"H

Lounge													
COMSL1	\$1963	\$2076	\$2160	\$2230	\$2390	\$2513	\$2594	\$2651	\$2920	\$3285	\$2179	\$3856	\$4061
COM/yds = 5¼, COL/sq ft = 115													

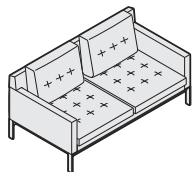

Overall: 35"D 64"W 28¾"H
Overall inside: 29"D 58"W 17"H
Inside to pillow: 22"D 58"W 17"H

Two-Seat													
COMSL2	\$2951	\$3161	\$3297	\$3413	\$3675	\$3878	\$4011	\$4104	\$4544	\$5144	\$3167	\$5953	\$6275
COM/yds = 8¼, COL/sq ft = 181													

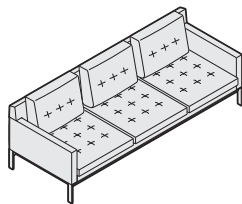

Overall: 35"D 92½"W 28¾"H
Overall inside: 29"D 87"W 17"H
Inside to pillow: 22"D 87"W 17"H

Three-Seat													
COMSL3	\$3679	\$3986	\$4173	\$4335	\$4421	\$4982	\$5167	\$5297	\$5909	\$6742	\$3895	\$7521	\$7930
COM/yds = 10½, COL/sq ft = 231													

► Specification information, continued on next page



For Canadian Pricing
Multiply U.S. Price by the Canadian price factor.
► See page 1 for details.

Millbrae Lounge *continued*

DESIGN COALESSE DESIGN STUDIO DESIGN ORIGIN: USA

► Specification information, continued from previous page

Specification Information

Style Number	U.S. Base Prices											Leather Grades:		
	Fabric Grades:											COL	C	E
	COM	6	7	8	9	10	11	12	13	14				

Contract Lounge Chairs

Without Arms

COMFL1	\$1703	\$1725	\$1759	\$1786	\$1852	\$1901	\$1932	\$1956	\$2063	\$2209	\$1919	\$2589	\$2687
--------	--------	--------	--------	--------	--------	--------	--------	--------	--------	--------	--------	--------	--------

COM/yds = 2¾, COL/sq ft = 60

With Arms

COMFLA1	\$1911	\$1970	\$2023	\$2068	\$2171	\$2249	\$2301	\$2338	\$2509	\$2743	\$2127	\$3351	\$3507
---------	--------	--------	--------	--------	--------	--------	--------	--------	--------	--------	--------	--------	--------

COM/yds = 4, COL/sq ft = 88

With Left Arm Facing

COMFLLA1	\$1807	\$1848	\$1890	\$1927	\$2011	\$2075	\$2118	\$2146	\$2286	\$2477	\$2023	\$2978	\$3106
----------	--------	--------	--------	--------	--------	--------	--------	--------	--------	--------	--------	--------	--------

COM/yds = 3¾, COL/sq ft = 72

With Right Arm Facing

COMFLRA1	\$1807	\$1848	\$1890	\$1927	\$2011	\$2075	\$2118	\$2146	\$2286	\$2477	\$2023	\$2978	\$3106
----------	--------	--------	--------	--------	--------	--------	--------	--------	--------	--------	--------	--------	--------

COM/yds = 3¾, COL/sq ft = 72

Contract Two-Seat Sofas

Without Arms

COMFL2	\$2691	\$2750	\$2803	\$2848	\$2951	\$3029	\$3081	\$3118	\$3289	\$3523	\$2907	\$4131	\$4287
--------	--------	--------	--------	--------	--------	--------	--------	--------	--------	--------	--------	--------	--------

COM/yds = 4½, COL/sq ft = 99

With Arms

COMFLA2	\$2899	\$2995	\$3067	\$3129	\$3270	\$3379	\$3450	\$3500	\$3736	\$4057	\$3115	\$4893	\$5108
---------	--------	--------	--------	--------	--------	--------	--------	--------	--------	--------	--------	--------	--------

COM/yds = 5¾, COL/sq ft = 126

With Left Arm Facing

COMFLLA2	\$2795	\$2871	\$2934	\$2988	\$3110	\$3205	\$3266	\$3310	\$3514	\$3790	\$3011	\$4504	\$4688
----------	--------	--------	--------	--------	--------	--------	--------	--------	--------	--------	--------	--------	--------

COM/yds = 5, COL/sq ft = 110

► Specification information, continued on next page



Overall: 30"D 26"W 31"H
Inside seat height: 22"D 17"H

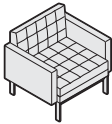

Overall: 30"D 32"W 31"H
Inside: 22"D 26½"W 17"H



Overall: 30"D 29"W 31"H
Inside: 22"D 26½"W 17"H

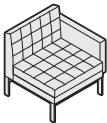

Overall: 30"D 29"W 31"H
Inside: 22"D 26½"W 17"H

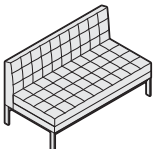

Overall: 30"D 52"W 31"H
Inside seat height: 22"D 17"H

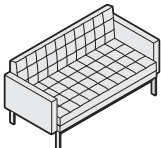

Overall: 30"D 58"W 31"H
Inside: 22"D 52½"W 17"H

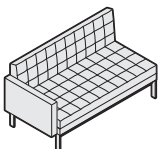

Overall: 30"D 55"W 31"H
Inside: 22"D 52¾"W 17"H

Millbrae Lounge

DESIGN COALESSE DESIGN STUDIO DESIGN ORIGIN: USA

► Specification information, continued from previous page

Specification Information

Style Number	U.S. Base Prices													
	Fabric Grades:											Leather Grades:		
	COM	6	7	8	9	10	11	12	13	14	COL	C	E	

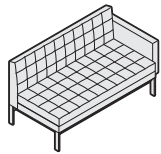

Overall: 30"D 55"W 31"H
Inside: 22"D 52¾"W 17"H

Contract Two-Seat Sofas, continued

With Right Arm Facing

COMFLRA2	\$2795	\$2871	\$2934	\$2988	\$3110	\$3205	\$3266	\$3310	\$3514	\$3790	\$3011	\$4504	\$4688
----------	--------	--------	--------	--------	--------	--------	--------	--------	--------	--------	--------	--------	--------

COM/yds = 5, COL/sq ft = 110

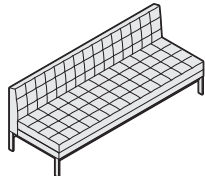

Overall: 30"D 78"W 31"H
Inside seat height: 22"D 17"H

Contract Three-Seat Sofas

Without Arms

COMFL3	\$3367	\$3463	\$3535	\$3597	\$3738	\$3847	\$3918	\$3968	\$4204	\$4525	\$3583	\$5361	\$5576
--------	--------	--------	--------	--------	--------	--------	--------	--------	--------	--------	--------	--------	--------

COM/yds = 6, COL/sq ft = 132

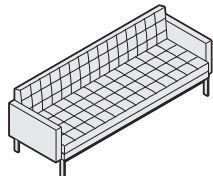

Overall: 30"D 84"W 31"H
Inside: 22"D 78½"W 17"H

With Arms

COMFLA3	\$3575	\$3705	\$3799	\$3879	\$4057	\$4196	\$4287	\$4351	\$4651	\$5060	\$3791	\$6124	\$6397
---------	--------	--------	--------	--------	--------	--------	--------	--------	--------	--------	--------	--------	--------

COM/yds = 7½, COL/sq ft = 159

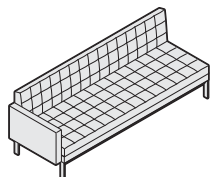

Overall: 30"D 81"W 31"H
Inside: 22"D 78¾"W 17"H

With Left Arm Facing

COMFLA3	\$3471	\$3584	\$3668	\$3738	\$3898	\$4021	\$4102	\$4159	\$4428	\$4793	\$3687	\$5751	\$5995
---------	--------	--------	--------	--------	--------	--------	--------	--------	--------	--------	--------	--------	--------

COM/yds = 6¾, COL/sq ft = 148

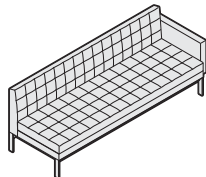

Overall: 30"D 81"W 31"H
Inside: 22"D 78¾"W 17"H

With Right Arm Facing

COMFLRA3	\$3471	\$3584	\$3668	\$3738	\$3898	\$4021	\$4102	\$4159	\$4428	\$4793	\$3687	\$5751	\$5995
----------	--------	--------	--------	--------	--------	--------	--------	--------	--------	--------	--------	--------	--------

COM/yds = 6¾, COL/sq ft = 148

► Specification information, continued on next page



For Canadian Pricing
Multiply U.S. Price by the
Canadian price factor.
► See page 1 for details.

Millbrae Lounge *continued*

DESIGN COALESSE DESIGN STUDIO DESIGN ORIGIN: USA

► Specification information, continued from previous page

Specification Information

Style Number	U.S. Base Prices														Leather Grades:		
	Fabric Grades:														COL	C	E
	COM	6	7	8	9	10	11	12	13	14							

Contract Four-Seat Sofas

Without Arms

COMFL4	\$3575	\$3705	\$3799	\$3879	\$4057	\$4196	\$4287	\$4351	\$4651	\$5060	\$3791	\$6124	\$6397
--------	--------	--------	--------	--------	--------	--------	--------	--------	--------	--------	--------	--------	--------

COM/yds = 7³/₄, COL/sq ft = 170

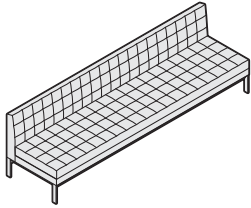

Overall: 30"D 104"W 31"H
Inside seat height: 22"D 17"H

With Arms

COMFLA4	\$3783	\$3950	\$4063	\$4159	\$4376	\$4545	\$4656	\$4732	\$5098	\$5595	\$3999	\$6886	\$7218
---------	--------	--------	--------	--------	--------	--------	--------	--------	--------	--------	--------	--------	--------

COM/yds = 8³/₄, COL/sq ft = 192

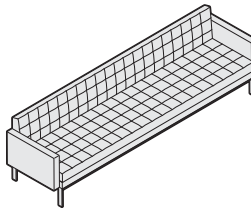

Overall: 30"D 110"W 31"H
Inside: 22"D 104¹/₂"W 17"H

With Left Arm Facing

COMFLLA4	\$3679	\$3829	\$3932	\$4018	\$4217	\$4370	\$4471	\$4542	\$4875	\$5327	\$3895	\$6496	\$6798
----------	--------	--------	--------	--------	--------	--------	--------	--------	--------	--------	--------	--------	--------

COM/yds = 8³/₄, COL/sq ft = 181

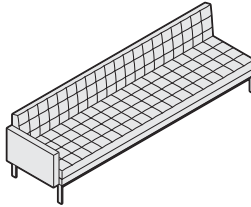

Overall: 30"D 107"W 31"H
Inside: 22"D 104³/₄"W 17"H

With Right Arm Facing

COMFLRA4	\$3679	\$3829	\$3932	\$4018	\$4217	\$4370	\$4471	\$4542	\$4875	\$5327	\$3895	\$6496	\$6798
----------	--------	--------	--------	--------	--------	--------	--------	--------	--------	--------	--------	--------	--------

COM/yds = 8³/₄, COL/sq ft = 181

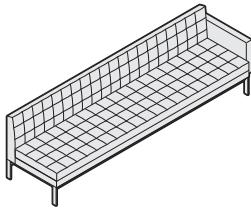

Overall: 30"D 107"W 31"H
Inside: 22"D 104³/₄"W 17"H

► Specification information, continued on next page



For Canadian Pricing
Multiply U.S. Price by the
Canadian price factor.
► See page 1 for details.

Millbrae Lounge

DESIGN COALESSE DESIGN STUDIO DESIGN ORIGIN: USA

► Specification information, continued from previous page

Specification Information

Style Number	U.S. Base Prices											Leather Grades:		
	Fabric Grades:											COL	C	E
	COM	6	7	8	9	10	11	12	13	14				

Benches

One-Seat Bench

COMFLB1	\$1391	\$1396	\$1418	\$1439	\$1484	\$1517	\$1541	\$1556	\$1631	\$1733	\$1607	\$2009	\$2077
---------	--------	--------	--------	--------	--------	--------	--------	--------	--------	--------	--------	--------	--------

COM/yds = 1¾, COL/sq ft = 39

Two-Seat Bench

COMFLB2	\$1911	\$1933	\$1967	\$1994	\$2060	\$2109	\$2140	\$2164	\$2271	\$2417	\$2127	\$2797	\$2895
---------	--------	--------	--------	--------	--------	--------	--------	--------	--------	--------	--------	--------	--------

COM/yds = 2¾, COL/sq ft = 60

Three-Seat Bench

COMFLB3	\$2223	\$2264	\$2306	\$2343	\$2427	\$2491	\$2534	\$2562	\$2702	\$2893	\$2439	\$3394	\$3522
---------	--------	--------	--------	--------	--------	--------	--------	--------	--------	--------	--------	--------	--------

COM/yds = 3¼, COL/sq ft = 72

Four-Seat Bench

COMFLB4	\$2431	\$2490	\$2543	\$2588	\$2691	\$2769	\$2821	\$2858	\$3029	\$3263	\$2647	\$3871	\$4027
---------	--------	--------	--------	--------	--------	--------	--------	--------	--------	--------	--------	--------	--------

COM/yds = 4½, COL/sq ft = 93

Round Arm Bolster

COMLPRND	\$ 256	\$ 235	\$ 247	\$ 255	\$ 274	\$ 288	\$ 299	\$ 306	\$ 337	\$ 381	\$ 472	\$ 503	\$ 533
----------	--------	--------	--------	--------	--------	--------	--------	--------	--------	--------	--------	--------	--------

COM/yds = ¾, COL/sq ft = 17

Square Arm Bolster

COMLPSQR	\$ 256	\$ 241	\$ 256	\$ 267	\$ 291	\$ 312	\$ 325	\$ 334	\$ 377	\$ 435	\$ 472	\$ 587	\$ 627
----------	--------	--------	--------	--------	--------	--------	--------	--------	--------	--------	--------	--------	--------

COM/yds = 1, COL/sq ft = 22

Ganging Kit

COMF1	\$ 57	N.A.	N.A.	N.A.	N.A.	N.A.	N.A.	N.A.	N.A.	N.A.	N.A.	N.A.	N.A.
-------	-------	------	------	------	------	------	------	------	------	------	------	------	------

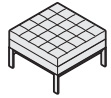

Overall: 26"D 26"W 16½"H

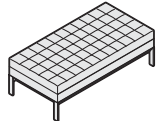

Overall: 26"D 52"W 16½"H

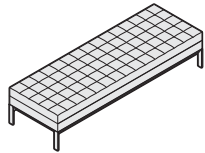

Overall: 26"D 78"W 16½"H

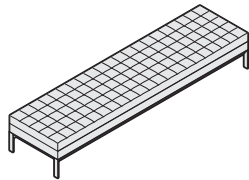

Overall: 26"D 104"W 16½"H



Overall: 18½"D 7"W 7"H



Overall: 18½"D 7"W 7"H

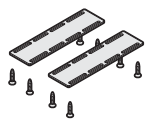

For Canadian Pricing
 Multiply U.S. Price by the
 Canadian price factor.
 ► See page 1 for details.

Millbrae

DESIGN COALESSE DESIGN STUDIO DESIGN ORIGIN: USA

Tip: Interport power/data module is not available on Millbrae.

Standard Includes	Required to Specify
<ul style="list-style-type: none"> Base: steel, painted black gloss Glass top: 3/4" thick glass Legs: 1/2" x 13/4": black gloss Glides 	1 Style number 2 Glass color number for top 3 Options, if selected (see below) ▶ See <i>Coalesse Surface Materials Reference Guide</i> .

Options	U.S. Price	Required to Specify
Surface Materials Base <ul style="list-style-type: none"> Brushed nickel for side table, 30" x 30" and 36" x 36" square tables and 20" x 54" and 30" x 60" rectangular tables Brushed nickel for 48" x 48" square table and rectangular tables 	+\$448 +\$515	Specify with <i>plated metal</i> . Specify with <i>plated metal</i> .

Specification Information									
Dimensions			Style Number	U.S. Base Prices					
D	W	H		Top Surface:					
				Clear	Clear Green	Absolute Clear/	Absolute	Colored	
				Green	Laminated/ Clear Green Frosted Appearance	Clear Frosted	Clear	Glass	

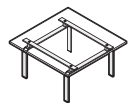

Square Tables

Dimensions	Style Number	Clear	Clear Green	Absolute Clear/ Clear Frosted	Absolute Clear	Colored Glass
30" x 30" x 15"	COMOTL3030	\$1665	\$1702	\$1774	\$1816	\$1905
36" x 36" x 15"	COMOTL3636	\$1977	\$2024	\$2128	\$2190	\$2321
48" x 48" x 15"	COMOTL4848	\$2705	\$2784	\$2955	\$3084	\$3309

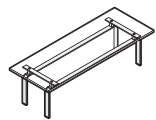

Rectangular Tables

Dimensions	Style Number	Clear	Clear Green	Absolute Clear/ Clear Frosted	Absolute Clear	Colored Glass
20" x 54" x 15"	COMOTL2054	\$2185	\$2247	\$2316	\$2368	\$2472
30" x 60" x 15"	COMOTL3060	\$2393	\$2455	\$2596	\$2695	\$2866



Side Table

Dimensions	Style Number	Clear	Clear Green	Absolute Clear/ Clear Frosted	Absolute Clear	Colored Glass
20" x 20" x 20"	COMOTL2020	\$1353	\$1380	\$1410	\$1420	\$1462



For Canadian Pricing
 Multiply U.S. Price by the Canadian price factor.
 ▶ See page 1 for details.

Coalesse

Millbrae Multi-Fabric Diagram

DESIGN COALESSE DESIGN

TO: _____

FROM: _____

DATE: _____

FAX...888.413.5161

Lifestyle

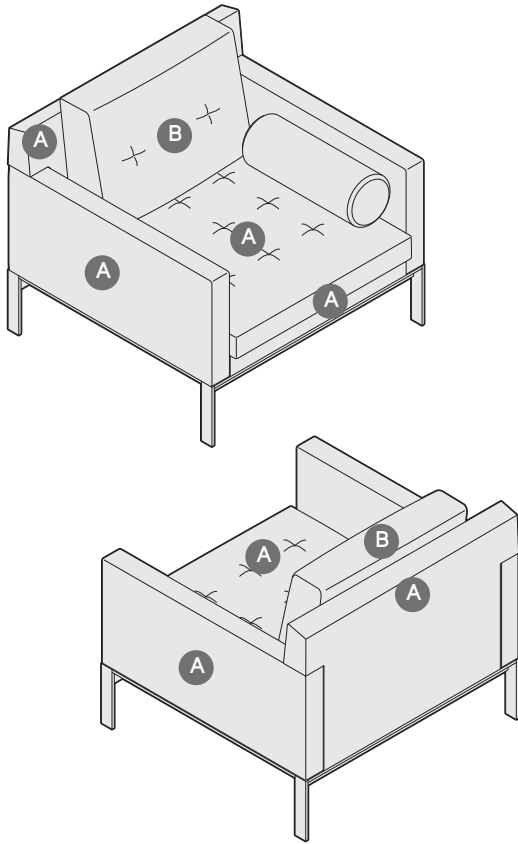

A Seat, Back, and Arms: _____

B Back Pillow: _____

Tip: Arm bolsters must be specified separately.

Tip: Attachment straps are standard on back pillow of lifestyle chairs.

Lounge Seating

Coalesse

Millbrae Multi-Fabric Diagram *continued*

DESIGN COALESSE DESIGN

TO: _____

FROM: _____

DATE: _____

FAX....888.413.5161

Contract

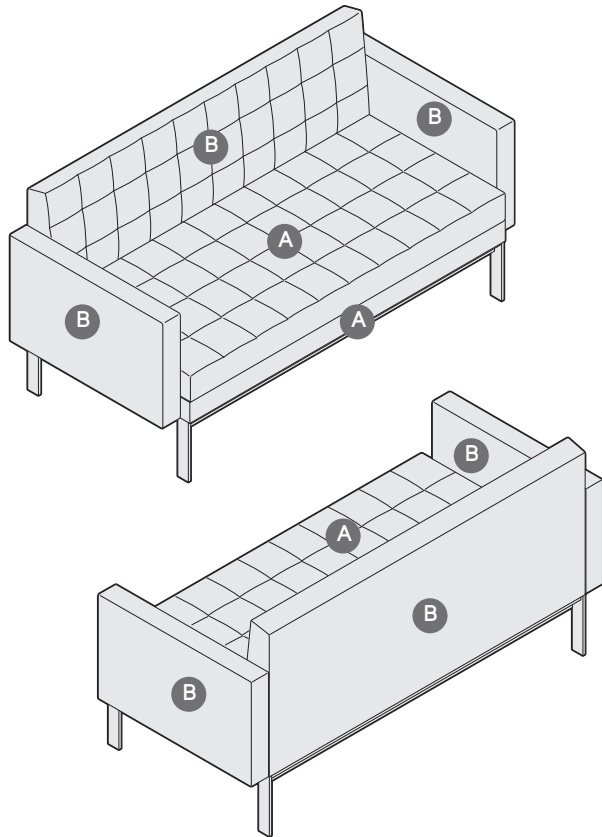

A Seat: _____

B Back and Arms: _____

Tip: Arm bolsters must be specified separately.

Coalesse

Millbrae Multi-Fabric Diagram

DESIGN COALESSE DESIGN

Pasio

DESIGN EDGAR REUTER DESIGN ORIGIN: GERMANY

Tip: Fabrics and leathers will appear loose with comfort wrinkles when upholstered.

Tip: Recommended leathers are Elmosoft Grade C and Elmorustical Grade E.

Tip: Special color match, consult customer service.

Tip: For Customer's Own Material or Leather, see necessary requirements, important processing instructions, and ordering information
 ▶ See *Coalesse Surface Materials Reference Guide*.

Standard Includes	Required to Specify
<ul style="list-style-type: none"> • Frame: unibody construction with finger-jointed plywood • Upholstery: multiple densities of polyurethane foam and polyester fiber on seat, back, and arms • Legs: solid maple with non-adjustable glides 	<ol style="list-style-type: none"> 1 Style number 2 Number of fabrics if contrasting fabric style number is selected 3 Fabric or leather color number for upholstery on seat and back 4 Wood color number for legs ▶ See <i>Coalesse Surface Materials Reference Guide</i> . 5 Options, if selected (see below) ▶ See <i>Coalesse Surface Materials Reference Guide</i> .

Options	U.S. Price	Required to Specify
Surface Materials		
• Contrasting fabric	+\$113 per fabric	Add suffix K to the style number and select fabric color number.
• Contrasting welt	+\$125	Specify <i>with contrasting welt</i> and select fabric color number.
Fire code seating		
• CAL 133 for chair	+\$218	Specify <i>with CAL 133</i> .
• CAL 133 for two-seat sofa	+\$437	Specify <i>with CAL 133</i> .
• CAL 133 for three-seat sofa	+\$568	Specify <i>with CAL 133</i> . ▶ See <i>Coalesse Surface Materials Reference Guide</i> .
Acrylic backer		
• Backer for chair	+\$ 44	Specify <i>with acrylic backer</i> .
• Backer for two-seat sofa	+\$ 64	Specify <i>with acrylic backer</i> .
• Backer for three-seat sofa	+\$ 81	Specify <i>with acrylic backer</i> .
• Backer for pillow	+\$ 8	Specify <i>with acrylic backer</i> . ▶ See <i>Coalesse Surface Materials Reference Guide</i> .

Specification Information													
Style Number	U.S. Base Prices											Leather Grades:	
	Fabric Grades:											COL	C
	COM	6	7	8	9	10	11	12	13	14			

Chair

263	\$1938	\$2059	\$2105	\$2150	\$2229	\$2294	\$2485	\$2616	\$2726	\$3024	\$2200	\$4599	\$4939
-----	--------	--------	--------	--------	--------	--------	--------	--------	--------	--------	--------	--------	--------

COM/yds = 5, COL/sq ft = 110

Two-Seat Sofa

263-2	\$3040	\$3235	\$3308	\$3365	\$3490	\$3587	\$3876	\$4070	\$4237	\$4702	\$3296	\$6916	\$7325
-------	--------	--------	--------	--------	--------	--------	--------	--------	--------	--------	--------	--------	--------

COM/yds = 7½, COL/sq ft = 165

▶ Specification Information, continued on next page

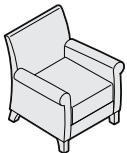

Overall: 30"D 31"W 35"H
 Inside: 21"D 21"W 23"H
 Seat: 16"H
 Arm: 25"H

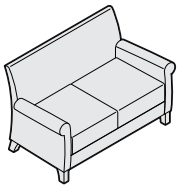

Overall: 30"D 56"W 35"H
 Inside: 21"D 46"W 23"H
 Seat: 16"H
 Arm: 25"H



For Canadian Pricing
 Multiply U.S. Price by the Canadian price factor.
 ▶ See page 1 for details.

Pasio

DESIGN EDGAR REUTER DESIGN ORIGIN: GERMANY

► Specification Information, continued from previous page

Specification Information

Style Number	U.S. Base Prices											Leather Grades:		
	Fabric Grades:											COL	C	E
	COM	6	7	8	9	10	11	12	13	14				

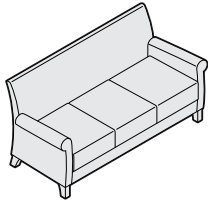

Overall: 30"D 71"W 35"H
 Inside: 21"D 61"W 23"H
 Seat: 16"H
 Arm: 25"H

Three-Seat Sofa

263-3	\$3996	\$4254	\$4344	\$4424	\$4572	\$4685	\$5056	\$5288	\$5483	\$6093	\$4263	\$8537	\$8935
-------	--------	--------	--------	--------	--------	--------	--------	--------	--------	--------	--------	--------	--------

COM/yds = 9¼, COL/sq ft = 204



Overall: 6"D 17"W 17"H

Pillow

263A	\$ 211	\$ 229	\$ 235	\$ 246	\$ 270	\$ 315	\$ 349	\$ 378	\$ 392	\$ 409	\$ 478	\$ 752	\$1008
------	--------	--------	--------	--------	--------	--------	--------	--------	--------	--------	--------	--------	--------

COM/yds = 1, COL/sq ft = 18

Lounge Seating



For Canadian Pricing
 Multiply U.S. Price by the
 Canadian price factor.
 ► See page 1 for details.

Passerelle Lounge

DESIGN STUDIO B DESIGN ORIGIN: UNITED STATES

Tip: Fabrics and leathers will appear loose with comfort wrinkles when upholstered.

Tip: Recommended leathers are Elmosoft Grade C and Elmorustical Grade E.

Tip: Special color match, consult customer service.

Tip: For Customer's Own Material or Leather, see necessary requirements, important processing instructions, and ordering information
 ▶ See *Coalesse Surface Materials Reference Guide*.

Standard Includes	Required to Specify
<ul style="list-style-type: none"> • Frame: unibody construction with finger jointed plywood • Upholstery: multiple densities of polyurethane foam and polyester fiber on seat, back, and arms • Legs: solid maple with non-adjustable glides 	1 Style number 2 Number of fabrics if contrasting fabric style number is selected 3 Fabric or leather color number for upholstery on seat, back, and arms 4 Wood color number for legs ▶ See <i>Coalesse Surface Materials Reference Guide</i> . 5 Options, if selected (see below) ▶ See <i>Coalesse Surface Materials Reference Guide</i> .

Options	U.S. Price	Required to Specify
Surface Materials <ul style="list-style-type: none"> • Contrasting fabric 	+\$113 per fabric	Add suffix K to the style number and select fabric color number.
Fire code seating <ul style="list-style-type: none"> • CAL 133 for chair • CAL 133 for loveseat • CAL 133 for sofa 	+\$218 +\$437 +\$568	Specify with <i>CAL 133</i> . Specify with <i>CAL 133</i> . Specify with <i>CAL 133</i> . ▶ See <i>Coalesse Surface Materials Reference Guide</i> .
Acrylic backer <ul style="list-style-type: none"> • Backer for chair • Backer for loveseat • Backer for sofa • Backer for arm bolster 	+\$ 31 +\$ 42 +\$ 52 +\$ 8	Specify with <i>acrylic backer</i> . Specify with <i>acrylic backer</i> . Specify with <i>acrylic backer</i> . Specify with <i>acrylic backer</i> . ▶ See <i>Coalesse Surface Materials Reference Guide</i> .
Attachment Straps <ul style="list-style-type: none"> • Attachment straps available on bolster pillow 	+\$ 59	Specify with <i>attachment straps</i> .

Specification Information

Style Number	U.S. Base Prices														Leather Grades:		
	Fabric Grades:														COL	C	E
	COM	6	7	8	9	10	11	12	13	14							

Chair

440-WB	\$1352	\$1474	\$1510	\$1545	\$1611	\$1675	\$1840	\$1953	\$1987	\$2195	\$1630	\$3690	\$4038
--------	--------	--------	--------	--------	--------	--------	--------	--------	--------	--------	--------	--------	--------

COM/yds = 4, COL/sq ft = 88

Loveseat

440-2WB	\$2509	\$2684	\$2748	\$2789	\$2885	\$2961	\$3192	\$3358	\$3386	\$3766	\$2792	\$5650	\$6035
---------	--------	--------	--------	--------	--------	--------	--------	--------	--------	--------	--------	--------	--------

COM/yds = 5½, COL/sq ft = 121

▶ Specification Information, continued on next page

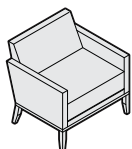

Overall: 27"D 30½"W 29"H
 Inside: 19"D 26"W 17"H
 Seat: 17½"H
 Arm: 23"H

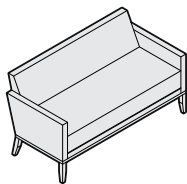

Overall: 27"D 56½"W 29"H
 Inside: 19"D 52"W 17"H
 Seat: 17½"H
 Arm: 23"H



For Canadian Pricing
 Multiply U.S. Price by the Canadian price factor.
 ▶ See page 1 for details.

Passerelle Lounge

DESIGN STUDIO B DESIGN ORIGIN: UNITED STATES

► Specification Information, continued from previous page

Specification Information

Style Number	U.S. Base Prices											Leather Grades:		
	Fabric Grades:											COL	C	E
	COM	6	7	8	9	10	11	12	13	14				

Sofa

440-3WB	\$2800	\$3022	\$3098	\$3151	\$3270	\$3364	\$3655	\$3838	\$3892	\$4322	\$3078	\$6620	\$7039
----------------	--------	--------	--------	--------	--------	--------	--------	--------	--------	--------	--------	--------	--------

COM/yds = 6¾, COL/sq ft = 149

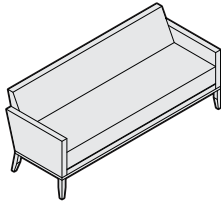

Overall: 27"D 72¾"W 29"H
 Inside: 19"D 68"W 17"H
 Seat: 17½"H
 Arm: 23"H



Overall: 17½"W 5¾"Dia

Arm Bolster

440-B	\$ 228	\$ 254	\$ 261	\$ 274	\$ 302	\$ 350	\$ 385	\$ 394	\$ 409	\$ 426	\$ 516	\$ 816	\$1101
--------------	--------	--------	--------	--------	--------	--------	--------	--------	--------	--------	--------	--------	--------

COM/yds = 1, COL/sq ft = 18

Lounge Seating



For Canadian Pricing
 Multiply U.S. Price by the
 Canadian price factor.
 ► See page 1 for details.

Passerelle Ottoman

DESIGN STUDIO B DESIGN ORIGIN: UNITED STATES

Tip: Fabrics and leathers will appear loose with comfort wrinkles when upholstered.

Tip: Recommended leathers are Elmosoft Grade C and Elmorustical Grade E.

Tip: Special color match, consult customer service.

Tip: For Customer's Own Material or Leather, see necessary requirements, important processing instructions, and ordering information
 ▶ See *Coalesse Surface Materials Reference Guide*.

Standard Includes

- Frame: unibody construction with finger jointed plywood
- Upholstery: multiple densities of polyurethane foam and polyester fiber
- Legs: solid maple with non-adjustable glides

Required to Specify

- 1 Style number
 - 2 Fabric or leather color number for upholstery
 - 3 Wood color number for legs
 - 4 Options, if selected (see below)
- ▶ See *Coalesse Surface Materials Reference Guide*.
 ▶ See *Coalesse Surface Materials Reference Guide*.

Options

Surface Materials	Options	U.S. Price	Required to Specify
	Fire code seating		
	• CAL 133 for 17"D x 17"W and 20"D x 26"W ottoman	+\$218	Specify with CAL 133.
	• CAL 133 for 36"D x 36"W ottoman	+\$437	Specify with CAL 133. ▶ See <i>Coalesse Surface Materials Reference Guide</i> .
	Acrylic backer		
	• Backer for 17"D x 17"W ottoman	+\$ 8	Specify with acrylic backer.
	• Backer for 20"D x 26"W ottoman	+\$ 12	Specify with acrylic backer.
	• Backer for 36"D x 36"W ottoman	+\$ 23	Specify with acrylic backer. ▶ See <i>Coalesse Surface Materials Reference Guide</i> .

Specification Information

Style Number	U.S. Base Prices														Leather Grades:		
	COM	6	7	8	9	10	11	12	13	14	COL	C	E				

Ottoman

440-H1717WB	\$ 849	\$ 869	\$ 882	\$ 905	\$ 928	\$ 947	\$1011	\$1054	\$1064	\$1188	\$1126	\$1886	\$2140
COM/yds = 1½, COL/sq ft = 33													

440-H2026WB	\$ 994	\$1033	\$1057	\$1068	\$1115	\$1146	\$1221	\$1286	\$1291	\$1439	\$1271	\$2290	\$2563
COM/yds = 2, COL/sq ft = 44													

440-H3636WB	\$1279	\$1353	\$1383	\$1406	\$1454	\$1495	\$1608	\$1691	\$1711	\$1903	\$1562	\$2990	\$3291
COM/yds = 2¾, COL/sq ft = 61													



Overall: 17"D 17"W 17"H

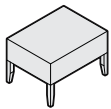

Overall: 20"D 26"W 17"H

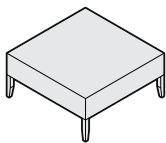

Overall: 36"D 36"W 17"H



For Canadian Pricing
 Multiply U.S. Price by the Canadian price factor.
 ▶ See page 1 for details.

Passerelle Benches

DESIGN STUDIO B DESIGN ORIGIN: UNITED STATES

Tip: Fabrics and leathers will appear loose with comfort wrinkles when upholstered.

Tip: For plain upholstery option or contrasting textiles, contact customer service.

Tip: Recommended leathers are Elmosoft Grade C and Elmorustical Grade E.

Tip: Special color match, consult customer service.

Tip: For Customer's Own Material or Leather, see necessary requirements, important processing instructions, and ordering information
 ▶ See *Coalesse Surface Materials Reference Guide*.

Standard Includes

- Frame: solid maple
- Upholstery: multiple densities of polyurethane foam
- Legs: solid maple with non-adjustable glides
- Button detail: tufted and double needed

Required to Specify

- 1 Style number
 - 2 Fabric or leather color number for upholstery on bench
 - 3 Wood color number for legs
 - 4 Options, if selected (see below)
- ▶ See *Coalesse Surface Materials Reference Guide*.
 ▶ See *Coalesse Surface Materials Reference Guide*.

Options

Surface Materials	Options	U.S. Price	Required to Specify
	Fire code seating		
	• CAL 133	+\$437	Specify with CAL 133. ▶ See <i>Coalesse Surface Materials Reference Guide</i> .
	Acrylic backer		
	• Backer for 20"D x 60"W bench	+\$ 23	Specify with acrylic backer.
	• Backer for 40"D x 40"W bench	+\$ 31	Specify with acrylic backer.
	• Backer for 30"D x 60"W bench	+\$ 35	Specify with acrylic backer. ▶ See <i>Coalesse Surface Materials Reference Guide</i> .

Specification Information

Style Number	U.S. Base Prices										Leather Grades:		
	Fabric Grades:										COL	C	E
	COM	6	7	8	9	10	11	12	13	14			

Bench

440-B3060WB	\$1677	\$1781	\$1834	\$1862	\$1929	\$1982	\$2105	\$2211	\$2255	\$2508	\$1965	\$4037	\$4408
COM/yds = 4, COL/sq ft = 88													

440-B4040WB	\$1643	\$1729	\$1759	\$1795	\$1854	\$1907	\$2007	\$2109	\$2145	\$2391	\$1932	\$3739	\$4057
COM/yds = 3½, COL/sq ft = 77													

440-B2060WB	\$1493	\$1549	\$1587	\$1602	\$1650	\$1698	\$1762	\$1846	\$1882	\$2104	\$1776	\$3198	\$3458
COM/yds = 2¾, COL/sq ft = 61													

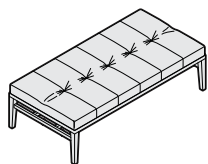

Overall: 30"D 60"W 17"H

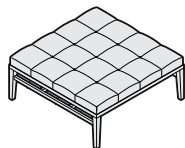

Overall: 40"D 40"W 17"H

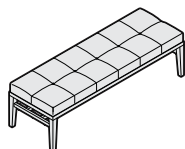

Overall: 20"D 60"W 17"H

 **For Canadian Pricing**
 Multiply U.S. Price by the Canadian price factor.
 ▶ See page 1 for details.

Ripple Benches

DESIGN LAURINDA SPEAR,FAIA DESIGN ORIGIN: UNITED STATES

Tip: Fabrics and leathers will appear loose with comfort wrinkles when upholstered.

Tip: Pricing based on highest grade textile specified.

Tip: Due to the design and construction techniques of Ripple lounge, only certain textiles can be successfully applied, therefore COM fabrics must be submitted to Coalesse for approval prior to order acceptance. Solid patterns with no repeat are recommended.

Tip: Recommended leathers are Elmosoft Grade C and Elmorustical Grade E.

Tip: Special color match, consult customer service.

Tip: For Customer's Own Material or Leather, see necessary requirements, important processing instructions, and ordering information
 ▶ See *Coalesse Surface Materials Reference Guide*.

Tip: 35" is a single seat and 96" three seat/sofa.

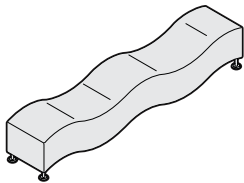

Overall: 19¼"D 97"W 19¼"H
 Dip: 14"H

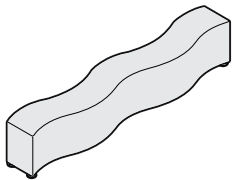

Overall: 19¼"D 97"W 19¼"H
 Seat Surface: 19"H

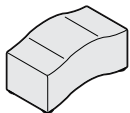

Overall: 19"D 35¾"W 19¼"H

 **For Canadian Pricing**
 Multiply U.S. Price by the Canadian price factor.
 ▶ See page 1 for details.

Standard Includes	Required to Specify
<ul style="list-style-type: none"> • Frame: unibody construction with finger jointed plywood • Upholstery: multiple densities of laminated polyurethane foam • Glides: height adjustable with stainless steel finish leveling polyurethane glides • Double needle stitch seams 	<ol style="list-style-type: none"> 1 Style number 2 Number of fabrics if contrasting fabric style number is selected 3 Fabric or leather color number for upholstery on bench 4 Options, if selected (see below) ▶ See <i>Coalesse Surface Materials Reference Guide</i> .

Options	U.S. Price	Required to Specify
Surface Materials <ul style="list-style-type: none"> • Contrasting fabric 	+\$113 per fabric	Add suffix K to the style number and select fabric color number.
Fire code seating <ul style="list-style-type: none"> • CAL 133 for wave and flat seats • CAL 133 for Little Ripple wave and flat seats 	+\$568 +\$218	Specify with CAL 133. Specify with CAL 133. ▶ See <i>Coalesse Surface Materials Reference Guide</i> .
Acrylic backer <ul style="list-style-type: none"> • Backer for wave and flat seats • Backer for Little Ripple wave and flat seats 	+\$ 64 +\$ 27	Specify with acrylic backer. Specify with acrylic backer. ▶ See <i>Coalesse Surface Materials Reference Guide</i> .

Specification Information														
Style Number	U.S. Base Prices												Leather Grades:	
	Fabric Grades:												COL	C
COM	6	7	8	9	10	11	12	13	14					

Upholstered Wave Seat

490-B96VRT	\$1748	\$1953	\$2023	\$2081	\$2199	\$2294	\$2590	\$2780	\$2983	\$3464	\$2013	\$5107	\$5661
------------	--------	--------	--------	--------	--------	--------	--------	--------	--------	--------	--------	--------	--------

COM/yds = 7½, COL/sq ft = 143

Upholstered Flat Seat

490-B96HRZ	\$1748	\$1953	\$2023	\$2081	\$2199	\$2294	\$2590	\$2780	\$2983	\$3464	\$2013	\$5107	\$5661
------------	--------	--------	--------	--------	--------	--------	--------	--------	--------	--------	--------	--------	--------

COM/yds = 7½, COL/sq ft = 143

Little Ripple Wave Seat

490-B35VRT	\$ 747	\$ 773	\$ 803	\$ 821	\$ 851	\$ 880	\$ 969	\$1028	\$1086	\$1265	\$1002	\$2051	\$2239
------------	--------	--------	--------	--------	--------	--------	--------	--------	--------	--------	--------	--------	--------

COM/yds = 2¼, COL/sq ft = 50

▶ Specification Information, continued on next page

Coalesse

Ripple Benches

DESIGN LAURINDA SPEAR,FAIA DESIGN ORIGIN: UNITED STATES

► Specification Information, continued from previous page

Specification Information

Style Number	U.S. Base Prices											Leather Grades:		
	Fabric Grades:											COL	C	E
	COM	6	7	8	9	10	11	12	13	14				

Little Ripple Flat Seat

490-B35HRZ	\$747	\$773	\$803	\$821	\$851	\$880	\$969	\$1028	\$1086	\$1265	\$1002	\$2051	\$2239
------------	-------	-------	-------	-------	-------	-------	-------	--------	--------	--------	--------	--------	--------

COM/yds = 2¼, COL/sq ft = 50

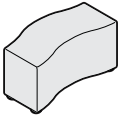

Overall: 19"D 35½"W 19"H

Lounge Seating



For Canadian Pricing
 Multiply U.S. Price by the
 Canadian price factor.
 ► See page 1 for details.

Sidewalk Lounge/Mobile

DESIGN STUDIO B DESIGN ORIGIN: UNITED STATES

Tip: Fabrics and leathers will appear loose with comfort wrinkles when upholstered.

Tip: Coordinating Sidewalk tables, ottomans, benches, and credenzas are available on pages 190, 354 and 357.

Tip: Recommended leathers are Elmosoft Grade C and Elmorustical Grade E.

Tip: Special color match, consult Customer Service.

Tip: For multi-fabric diagram, refer to page 186.

Tip: Specify tablet from facing position.

Tip: Cup holder attaches to tablet.

Tip: For Customer's Own Material or Leather, see necessary requirements, important processing instructions, and ordering information
 ▶ See *Coalesse Surface Materials Reference Guide*.

Tip: Extra pivoter allows tablet to be moved side to side.

Tip: Tablet can be installed on mobile models only.

Standard Includes	Required to Specify
<ul style="list-style-type: none"> • Frame: unibody construction with finger jointed plywood • Upholstery: multiple densities of polyurethane foam and polyester fiber on seat, back, and arms. • Lounge: <ul style="list-style-type: none"> - Legs: silver powder coat steel legs with "Go" glide • Mobile: <ul style="list-style-type: none"> - 13½" diameter tablet: laminate - Legs: Silver powder coat steel legs with casters - Casters: four non-locking 	<ol style="list-style-type: none"> 1 Style number 2 Number of fabrics if contrasting fabric style number is selected 3 Fabric or leather color number for upholstery on seat, back, and arms 4 Options, if selected (see below) ▶ See <i>Coalesse Surface Materials Reference Guide</i> .

Options	U.S. Price	Required to Specify
Surface Materials <ul style="list-style-type: none"> • Contrasting fabric 	+\$113 per fabric	Add suffix K to the style number and select fabric color number.
Fire code seating <ul style="list-style-type: none"> • CAL 133 for single chairs • CAL 133 for lounge two-seat chair 	+\$218 +\$437	Specify with <i>CAL 133</i> . Specify with <i>CAL 133</i> . ▶ See <i>Coalesse Surface Materials Reference Guide</i> .
Acrylic backer <ul style="list-style-type: none"> • Backer for lounge chair • Backer for lounge two-seat chair • Backer for arm bolster 	+\$ 35 +\$ 48 +\$ 8	Specify with <i>acrylic backer</i> . Specify with <i>acrylic backer</i> . Specify with <i>acrylic backer</i> . ▶ See <i>Coalesse Surface Materials Reference Guide</i> .
Tablet on Mobile Models only <ul style="list-style-type: none"> • Wood • Anodized aluminum 	+\$125 +\$205	Specify with <i>wood</i> and select wood color. Specify with <i>anodized aluminum</i> .
Cup Holder <ul style="list-style-type: none"> • Cup holder 	+\$ 47	Specify with <i>cup holder</i> .
Tablet Side Storage <ul style="list-style-type: none"> • Tablet side storage 	+\$ 69	Specify with <i>tablet side storage</i> and select or right-facing.
Extra Pivoter <ul style="list-style-type: none"> • Extra pivoter 	+\$170	Specify with <i>extra pivoter</i> .
Omit Tablet <ul style="list-style-type: none"> • Omit tablet 	-\$143	Specify with <i>omit tablet</i> .
Glides <ul style="list-style-type: none"> • Lounge • "No Go" ½" polyethylene glide 	No cost	Specify with <i>"no go"</i> .
<ul style="list-style-type: none"> • Mobile • Go glides 	No cost	Specify with <i>go glides</i> .
Casters <ul style="list-style-type: none"> • Locking casters 	No cost	Specify with <i>locking casters</i> .
Related Products <ul style="list-style-type: none"> • Ottomans/Benches • Sidewalk tables • Credenzas 		▶ See page 190 ▶ See page 354 ▶ See page 357

Specification Information

Style Number	U.S. Base Prices														Leather Grades:			
	Fabric Grades:														COL	C	E	
COM	6	7	8	9	10	11	12	13	14									

Lounge Lowback Chair

444	\$1328	\$1437	\$1480	\$1508	\$1580	\$1626	\$1793	\$1905	\$1950	\$2137	\$1599	\$3588	\$3912
-----	--------	--------	--------	--------	--------	--------	--------	--------	--------	--------	--------	--------	--------

COM/yds = 4, COL/sq ft = 88

▶ Specification Information, continued on next page

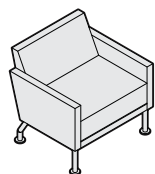

Overall: 27"D 30½"W 29"H
 Inside: 19"D 26"W 17"H
 Seat: 17½"H
 Arm: 23"H

Sidewalk Lounge/Mobile

DESIGN STUDIO B DESIGN ORIGIN: UNITED STATES

► Specification Information, continued from previous page

Specification Information

Style Number	U.S. Base Prices											Leather Grades:		
	Fabric Grades:											COL	C	E
	COM	6	7	8	9	10	11	12	13	14				

Lounge Highback Chair

446	\$1461	\$1583	\$1624	\$1667	\$1730	\$1790	\$1961	\$2085	\$2133	\$2339	\$1739	\$3864	\$4194
-----	--------	--------	--------	--------	--------	--------	--------	--------	--------	--------	--------	--------	--------

COM/yds = 4½, COL/sq ft = 99

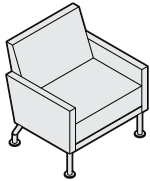

Overall: 27"D 30½"W 32"H
 Inside: 19"D 26"W 20"H
 Seat: 17½"H
 Arm: 23"H

Lounge Two-Seat

444-2	\$2105	\$2280	\$2339	\$2380	\$2469	\$2545	\$2776	\$2923	\$2981	\$3280	\$2383	\$5133	\$5499
-------	--------	--------	--------	--------	--------	--------	--------	--------	--------	--------	--------	--------	--------

COM/yds = 5½, COL/sq ft = 121

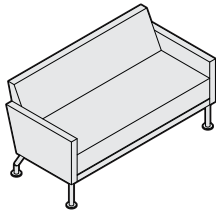

Overall: 27"D 56½"W 29"H
 Inside: 19"D 52"W 17"H
 Seat: 17½"H
 Arm: 23"H

Mobile Lowback Chair with Tablet

444M	\$1835	\$1928	\$1973	\$2010	\$2062	\$2127	\$2234	\$2340	\$2404	\$2665	\$2100	\$4089	\$4454
------	--------	--------	--------	--------	--------	--------	--------	--------	--------	--------	--------	--------	--------

COM/yds = 4, COL/sq ft = 88

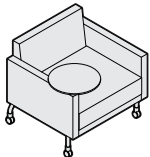

Overall: 27"D 30½"W 29"H
 Inside: 19"D 26"W 17"H
 Seat: 17½"H
 Arm: 22½"H

Mobile Highback Chair with Tablet

446M	\$1973	\$2094	\$2135	\$2172	\$2242	\$2301	\$2424	\$2550	\$2621	\$2904	\$2244	\$4487	\$4889
------	--------	--------	--------	--------	--------	--------	--------	--------	--------	--------	--------	--------	--------

COM/yds = 4½, COL/sq ft = 99

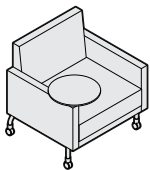

Overall: 27"D 30½"W 32"H
 Inside: 19"D 26"W 20"H
 Seat: 17½"H
 Arm: 22½"H

Arm Bolster

440-B	\$ 228	\$ 254	\$ 261	\$ 274	\$ 302	\$ 350	\$ 385	\$ 394	\$ 409	\$ 426	\$ 516	\$ 816	\$1101
-------	--------	--------	--------	--------	--------	--------	--------	--------	--------	--------	--------	--------	--------

COM/yds = 1, COL/sq ft = 18



Overall: 17½"H 5¾" Dia



For Canadian Pricing
 Multiply U.S. Price by the
 Canadian price factor.

► See page 1 for details.

Sidewalk Multi-Fabric Diagram

DESIGN STUDIO B DESIGN ORIGIN: UNITED STATES

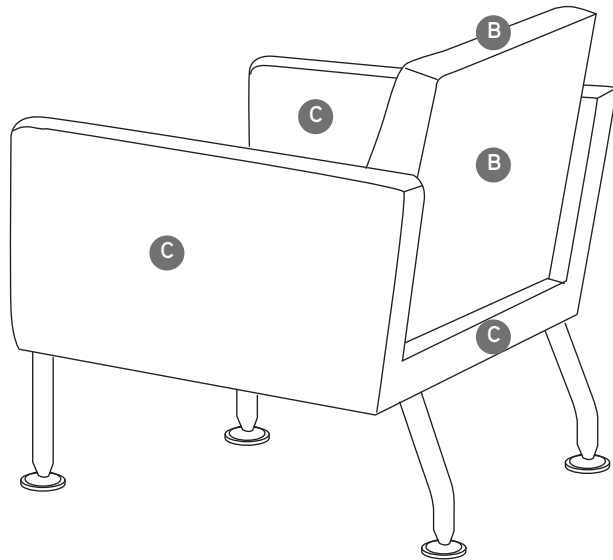
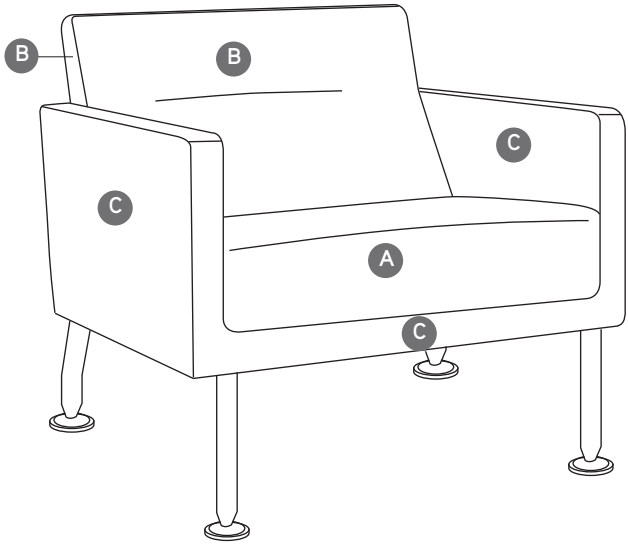

TO: _____

FROM: _____

DATE: _____

FAX....888.413.5161

A Upholstery Selection (default for entire unit if B is not selected):

B Back: _____

C Arms: _____

Total list price upcharge for contrasting fabrics: \$_____

*\$113 U.S. list per contrasting fabric specified. List price based on highest fabric grade usage.

Specify Model below:

444K Sidewalk Lowback Lounge or Mobile

446K Sidewalk Highback Lounge or Mobile

444-2K Sidewalk Two Seat Sofa



For Canadian Pricing
Multiply U.S. Price by the
Canadian price factor.
▶ See page 1 for details.

Coalesse

Sidewalk Multi-Fabric Diagram

DESIGN STUDIO B DESIGN ORIGIN: UNITED STATES

Sidewalk Collaborative

DESIGN STUDIO B DESIGN ORIGIN: UNITED STATES

Tip: Fabrics and leathers will appear loose with comfort wrinkles when upholstered.

Tip: Recommended leathers are Elmosoft Grade C and Elmorustical Grade E.

Tip: Special color match, consult Customer Service.

Tip: For Customer's Own Material or Leather, see necessary requirements, important processing instructions, and ordering information
 ▶ See *Coalesse Surface Materials Reference Guide*.

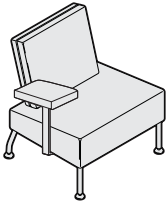

Tip: Overall width dimensions with arm options: 430: 35"W 430-2: 49"W. Overall inside width dimensions with arm options: 430: 19 1/2"W 430-2: 49"W

▶ See *Sidewalk multi-fabric diagram on page 191.*

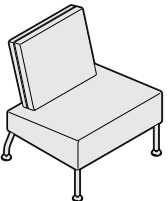

Overall: 27"D 27"W 30 1/2"H
Inside: 17"D 27"W 18"H
Seat: 17"H
Arm: 21"H



For Canadian Pricing
 Multiply U.S. Price by the Canadian price factor.
 ▶ See page 1 for details.

Standard Includes		Required to Specify	
	<ul style="list-style-type: none"> • Frame: unibody construction with finger jointed plywood • Upholstery: multiple densities of polyurethane foam and polyester fiber on seat and back • Legs: silver powder coat steel with "Go" glides 		<ol style="list-style-type: none"> 1 Style number 2 Number of fabrics if contrasting fabric style number is selected 3 Fabric or leather color number for upholstery on seat and back 4 Options, if selected (see below) ▶ See <i>Coalesse Surface Materials Reference Guide</i> .
Surface Materials	Options	U.S. Price	Required to Specify
	<ul style="list-style-type: none"> • Contrasting fabric 	+\$113 per fabric	Add suffix K to the style number and select fabric color number.
	Fire code seating <ul style="list-style-type: none"> • CAL 133 for chair and ottomans • CAL 133 for two-seat chair 	+\$218 +\$437	Specify with CAL 133. Specify with CAL 133. ▶ See <i>Coalesse Surface Materials Reference Guide</i> .
	Acrylic backer <ul style="list-style-type: none"> • Backer for chair • Backer for two-seat chair • Backer for 17"D x 17"W and 17"D x 20"W ottomans • Backer for 20"D x 26"W ottoman 	+\$ 21 +\$ 39 +\$ 12 +\$ 17	Specify with acrylic backer. Specify with acrylic backer. Specify with acrylic backer. Specify with acrylic backer. ▶ See <i>Coalesse Surface Materials Reference Guide</i> .
Attachment Straps	<ul style="list-style-type: none"> • Attachment straps available on 430 model • Attachment straps available on 430-2 model 	+\$ 59 +\$118	Specify with attachment straps. Specify with attachment straps.
Arms	<ul style="list-style-type: none"> • Arms on 430 and 430-2 3/4 yard or 14 sq. ft. required for COM/COL	+\$ 42 per arm	Specify with arms.
Glides	<ul style="list-style-type: none"> • "No Go" 1/2" polyethylene glides 	No cost	Specify with "no go" glides.

Specification Information													
Style Number	U.S. Base Prices											Leather Grades:	
	Fabric Grades:											COL	C
COM	6	7	8	9	10	11	12	13	14				

Chair													
430	\$1280	\$1365	\$1407	\$1442	\$1572	\$1614	\$1773	\$1910	\$1955	\$2136	\$1551	\$2772	\$3085

COM/yds = 2 3/4, COL/sq ft = 77
 ▶ Specification Information, continued on next page

► Specification Information, continued from previous page

Specification Information

Style Number	U.S. Base Prices											Leather Grades:		
	Fabric Grades:											COL	C	E
	COM	6	7	8	9	10	11	12	13	14				

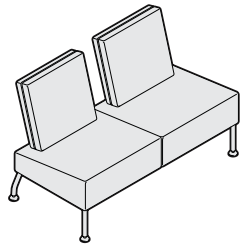

Overall: 27"D 49"W 30½"H
 Inside: 17"D 49"W 18"H
 Seat: 17"H
 Arm: 21"H

Two-Seat

430-2	\$1876	\$2021	\$2075	\$2151	\$2209	\$2288	\$2511	\$2658	\$2733	\$3000	\$2154	\$3981	\$4336
-------	--------	--------	--------	--------	--------	--------	--------	--------	--------	--------	--------	--------	--------

COM/yds = 4¼, COL/sq ft = 115

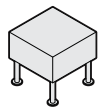

Overall: 17"D 17"W 17"H

Ottoman

430-H1717	\$ 798	\$ 808	\$ 825	\$ 837	\$ 903	\$ 920	\$ 978	\$1056	\$1080	\$1189	\$1076	\$1428	\$1671
-----------	--------	--------	--------	--------	--------	--------	--------	--------	--------	--------	--------	--------	--------

COM/yds = 1½, COL/sq ft = 22½

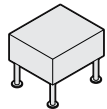

Overall: 17"D 20"W 17"H

430-H1720	\$ 798	\$ 808	\$ 825	\$ 837	\$ 903	\$ 920	\$ 978	\$1056	\$1080	\$1189	\$1076	\$1428	\$1671
-----------	--------	--------	--------	--------	--------	--------	--------	--------	--------	--------	--------	--------	--------

COM/yds = 1½, COL/sq ft = 24

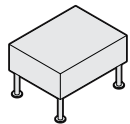

Overall: 20"D 26"W 17"H

430-H2026	\$ 942	\$ 962	\$ 988	\$1009	\$1040	\$1064	\$1147	\$1194	\$1227	\$1359	\$1207	\$1760	\$2009
-----------	--------	--------	--------	--------	--------	--------	--------	--------	--------	--------	--------	--------	--------

COM/yds = 2, COL/sq ft = 36



For Canadian Pricing
 Multiply U.S. Price by the
 Canadian price factor.
 ► See page 1 for details.

Sidewalk Ottoman/Benches

DESIGN STUDIO B DESIGN ORIGIN: UNITED STATES

Tip: Fabrics and leathers will appear loose with comfort wrinkles when upholstered.

Tip: Recommended leathers are Elmosoft Grade C and Elmorustical Grade E.

Tip: Special color match, consult customer service.

Tip: For Customer's Own Material or Leather, see necessary requirements, important processing instructions, and ordering information
 ▶ See *Coalesse Surface Materials Reference Guide*.

Standard Includes		Required to Specify	
	<ul style="list-style-type: none"> • Frame: unibody construction with finger jointed plywood. • Upholstery: multiple densities of polyurethane foam and polyester fiber on ottoman/benches • Legs: silver powder coat steel with "Go" glides 		1 Style number 2 Fabric or leather color number for upholstery on ottoman/benches 3 Options, if selected (see below) ▶ See <i>Coalesse Surface Materials Reference Guide</i> .
Options		U.S. Price	Required to Specify
Surface Material	Fire code seating <ul style="list-style-type: none"> • CAL 133 for benches and ottoman 	+\$218	Specify with <i>CAL 133</i> . ▶ See <i>Coalesse Surface Materials Reference Guide</i> .
	Acrylic backer <ul style="list-style-type: none"> • Backer for 17"D x 24"W bench • Backer for 17"D x 36"W bench • Backer for 17"D x 48"W bench • Backer for ottoman 	+\$ 12 +\$ 17 +\$ 21 +\$ 27	Specify with <i>acrylic backer</i> . Specify with <i>acrylic backer</i> . Specify with <i>acrylic backer</i> . Specify with <i>acrylic backer</i> . ▶ See <i>Coalesse Surface Materials Reference Guide</i> .
Glides	<ul style="list-style-type: none"> • "No Go" 1/2" polyethylene glides 	No cost	Specify with <i>"no go" glides</i> .

Specification Information														
Style Number	U.S. Base Prices												Leather Grades:	
	Fabric Grades:												COL	C
	COM	6	7	8	9	10	11	12	13	14				

Benches

430-B1724	\$ 865	\$ 880	\$ 904	\$ 915	\$ 933	\$ 950	\$1017	\$1055	\$1076	\$1196	\$1142	\$1548	\$1778
COM/yds = 1½, COL/sq ft = 27													

430-B1736	\$1003	\$1044	\$1059	\$1072	\$1107	\$1136	\$1214	\$1272	\$1293	\$1433	\$1275	\$1829	\$2089
COM/yds = 2, COL/sq ft = 36													

430-B1748	\$1147	\$1188	\$1216	\$1233	\$1280	\$1309	\$1411	\$1481	\$1517	\$1678	\$1412	\$2114	\$2374
COM/yds = 2½, COL/sq ft = 45													

Ottoman

430-H3636	\$1153	\$1216	\$1251	\$1274	\$1315	\$1352	\$1470	\$1540	\$1572	\$1733	\$1418	\$2793	\$3083
COM/yds = 2¾, COL/sq ft = 61													

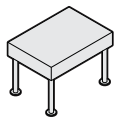

Overall: 17"D 24"W 17"H

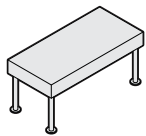

Overall: 17"D 36"W 17"H

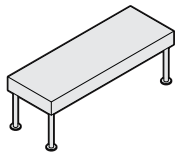

Overall: 17"D 48"W 17"H

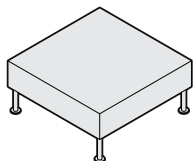

Overall: 36"D 36"W 17"H

Sidewalk Collaborative Multi-Fabric Diagram

DESIGN STUDIO B DESIGN ORIGIN: UNITED STATES

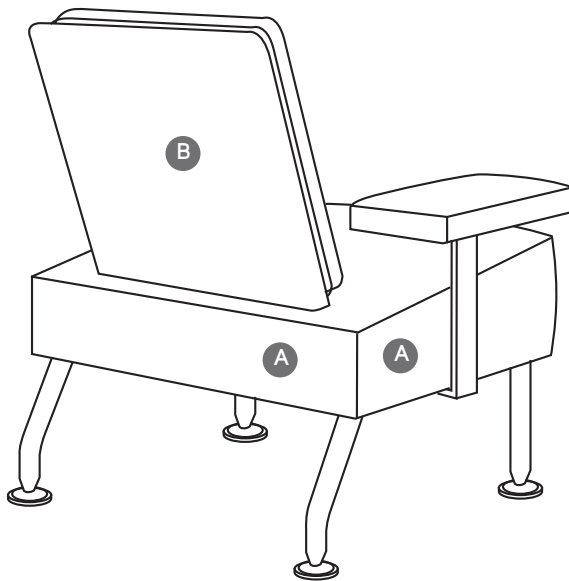
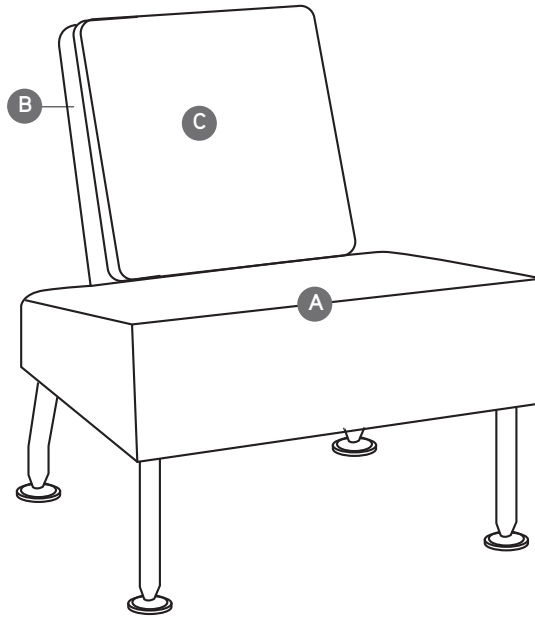

TO: _____

FROM: _____

DATE: _____

FAX....888.413.5161

A Upholstery Selection (default for entire unit if B is not selected): _____

B Back: _____

C Back Cushion: _____

Total list price upcharge for contrasting fabrics: \$ _____

*\$113 U.S. list per contrasting fabric specified. List price based on highest fabric grade usage.

Lounge Seating

 **For Canadian Pricing**
 Multiply U.S. Price by the Canadian price factor.
 ▶ See page 1 for details.

SW_1 Collaborative Lounge Seating

DESIGN SCOTT WILSON & MINIMAL DESIGN ORIGIN: UNITED STATES



Tip: For Customer's Own Material or Leather, see necessary requirements, important processing instructions, and ordering information
 ▶ See *Coalesse Surface Materials Reference Guide*.

Standard Includes	Required to Specify
<ul style="list-style-type: none"> • Seat: fabric or leather • Back: 3D knit • Base: 8040 Aluminum Matte Polished • Frame: steel tube • Glides: aluminum with non marring plastic insert • Swivel return mechanism • Lumbar pillow: fabric or leather • Ottoman: fabric or leather • Lounge tablet surface, if selected, 6000 Black or 6052 Milk • Lounge tablet arm support: paint to complement 8040 Aluminum Matte polished base 	<ol style="list-style-type: none"> 1 Style number 2 Fabric or leather color number for seat, lumbar pillow, or ottoman 3 3D Knit color number for back: <ul style="list-style-type: none"> 5K20 Stone 5K21 Grey 5K23 Brown 5K24 Black 5K25 Garnet 5K26 Golden 5K27 Royal 5K28 Ivory 5K29 Coal 4 Color number for lounge tablet surface, if selected: <ul style="list-style-type: none"> 6000 Black 6052 Milk 5 Options, if selected (see below) ▶ See <i>Coalesse Surface Materials Reference Guide</i> .

	Options	U.S. Price	Required to Specify
Surface Materials	• Contrasting fabric	+\$113 per fabric	Add suffix K to the style number and select fabric color number.
	Fire code seating		
	• CAL 133 for chairs and ottoman	+\$218	Specify with <i>CAL 133</i> .
Mechanism	Acrylic backer		
	• Backer for chairs	+\$ 27	Specify with <i>acrylic backer</i> .
	• Backer for ottoman	+\$ 12	Specify with <i>acrylic backer</i> .
	• Backer for lumbar pillow	+\$ 6	Specify with <i>acrylic backer</i> . ▶ See <i>Coalesse Surface Materials Reference Guide</i> .
Related Products	• Swivel-only mechanism (omit return feature)	No cost	Specify with <i>swivel-only mechanism</i> .
	• Occasional and conference tables		▶ See <i>Coalesse Conferencing and Storage Specification Guide</i> .



For Canadian Pricing
 Multiply U.S. Price by the Canadian price factor.
 ▶ See page 1 for details.

SW_1 Collaborative Lounge Seating

DESIGN SCOTT WILSON & MINIMAL DESIGN ORIGIN: UNITED STATES



Overall: 28³/₄"D 32¹/₄"W 36³/₄"H
 Seat: 16"H
 Arm: 23"H



Overall: 30"D 32¹/₄"W 41³/₄"H
 Seat: 16"H
 Arm: 23"H



Overall: 5"D 15"W 7"H



Overall: 20"D 23"W 14"H

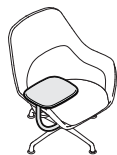

Tip: Handedness is determined while in the seated position.

Specification Information

Style Number	U.S. Base Prices											Leather Grades:		
	Fabric Grades:											COL	C	E
	COM	6	7	8	9	10	11	12	13	14				

Lowback Collaborative Lounge Swivel Return Chairs

COW612	\$1929	\$1963	\$2004	\$2039	\$2116	\$2176	\$2215	\$2244	\$2373	\$2551	\$2145	\$2910	\$3018
--------	--------	--------	--------	--------	--------	--------	--------	--------	--------	--------	--------	--------	--------

COM/yds = 3, COL/sq ft = 60

Highback Collaborative Lounge Swivel Return Chairs

COW712	\$2244	\$2278	\$2319	\$2354	\$2431	\$2491	\$2530	\$2559	\$2688	\$2866	\$2460	\$3225	\$3333
--------	--------	--------	--------	--------	--------	--------	--------	--------	--------	--------	--------	--------	--------

COM/yds = 3, COL/sq ft = 60

Lumbar Pillow

COW110	\$ 243	\$ 222	\$ 234	\$ 242	\$ 261	\$ 275	\$ 286	\$ 293	\$ 324	\$ 368	\$ 459	\$ 450	\$ 457
--------	--------	--------	--------	--------	--------	--------	--------	--------	--------	--------	--------	--------	--------

COM/yds = 3/4, COL/sq ft = 16

Ottoman

COW210	\$ 998	\$ 983	\$ 998	\$1009	\$1033	\$1054	\$1067	\$1076	\$1119	\$1177	\$1214	\$1329	\$1369
--------	--------	--------	--------	--------	--------	--------	--------	--------	--------	--------	--------	--------	--------

COM/yds = 1, COL/sq ft = 22

Specification Information

D	W	H (From Floor)	Style Number	U.S. Base Price
---	---	-------------------	--------------	-----------------

Left-Hand Tablet

15"	12"	25 ³ / ₁₆ "	COWTABL	\$613
-----	-----	-----------------------------------	---------	-------

Right-Hand Tablet

15"	12"	25 ³ / ₁₆ "	COWTABR	\$613
-----	-----	-----------------------------------	---------	-------

SW_1 Low Collaborative Conference Tables

DESIGN SCOTT WILSON & MINIMAL



Tip: Your specification is not complete until you add the fifth letter to the style number to define top surface.

- L - Laminate top
- V - Wood veneer top
- C - Corian top
- G - Glass top

Tip: Standard grain direction runs the width of the table (front-to back).

Tip: If grommet with wire manager is selected, the finish is not selectable, it will be the same as the substructure finish choice.

Tip: Tablets are an optional pick for the 42" and 84" square and 84"L and 120"L rectangular tables only. Tablets are available in black or milk finish.

Veneer direction



Standard Includes	Required to Specify
<ul style="list-style-type: none"> 1/2" thick top surface: <ul style="list-style-type: none"> - Laminate (Grade 1) with 3 mm edge band, if selected - Wood veneer (Grade 1) with matching 3 mm edge band, if selected - Corian, if selected: white only - Glass, if selected 1/4" thick bottom substructure: black or milk • Base, column, and cone: 8040 Polished Matte Aluminum • Glides • Ships ready-to assemble 	<p>1 Style number with appropriate top series letter indicated in the space provided. (For example: COWX_Q42 becomes COWXLQ42 for a laminate top surface):</p> <ul style="list-style-type: none"> L - Laminate top V - Wood veneer top C - Corian top G - Glass top <p>2 Laminate, wood, or glass color number for top, if selected</p> <p>3 Plastic color for edge band of laminate top, if selected</p> <p>4 Bottom substructure: 6000 Black 6052 Milk</p> <p>5 Options, if selected (see below) ▶ See <i>Coalesse Surface Materials Reference Guide</i>.</p>

	Options	U.S. Price	Required to Specify
Surface Materials	Laminate		
	• Grade 2 laminate	Prices at right	Specify with <i>Grade 2 laminate</i> and select color number.
	Wood		
	• Grade 2 wood veneer	Prices at right	Specify with <i>Grade 2 wood veneer</i> and select color number.
	• Stain-to-Match	No cost	Specify with <i>Stain-to-Match</i>
Wood Veneer Grain Direction	• Lengthwise grain direction for tops up to 96"L	No cost	Specify with <i>lengthwise grain direction</i> .
Grommet with Wire Management	42" square and 120"L tables (center only)		
	• One grommet	+\$ 179	Specify with <i>one grommet with wire manager</i> .
	60" and 72" large round and square tables		
	• One grommet	+\$ 179	Specify with <i>one grommet with wire manager</i> .
	• Two grommets	+\$ 358	Specify with <i>two grommets with wire manager</i> .
	84" and 96" large round and square tables		
	• Two grommets	+\$ 358	Specify with <i>two grommets with wire manager</i> .
• Four grommets	+\$ 716	Specify with <i>four grommets with wire manager</i> .	
72"L, 84"L, and 96"L tables (end (V-leg) location only)	• One grommet	+\$ 179	Specify with <i>one grommet with wire manager</i> .
	72"L, 84"L, 96"L, and 120"L tables (outer ends (V-legs) location only)		
	• Two grommets	+\$ 358	Specify with <i>two grommets with wire manager</i> .
Tablets	42" square tables		
	• Two tablets: black or milk plastic	+\$ 855	Specify with <i>two tablets</i> and select plastic color number.
	• Four tablets: black or milk plastic	+\$1710	Specify with <i>four tablets</i> and select plastic color number.
	84"L rectangular tables		
	• Six tablets: black or milk plastic	+\$2565	Specify with <i>six tablets</i> and select plastic color number.
84" square table and 120"L rectangular tables	• Eight tablets: black or milk plastic	+\$3420	Specify with <i>eight tablets</i> and select plastic color number.

Related Products	• SW_1 lounge	▶ Page 192
-------------------------	---------------	------------

SW_1 Low Collaborative Conference Tables

DESIGN SCOTT WILSON & MINIMAL

Tip: Your specification is not complete until you add the fifth letter to the style number to define top surface.

- L - Laminate top
- V - Wood veneer top
- C - Corian top
- G - Glass top

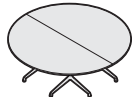
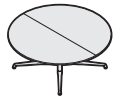

Tip: 60" and 72" round and square table base consists of four single legs. The 84" and 96" round and square table base consists of four v-legs.



Tip: Tablets are an optional pick for the 42" square tables only.

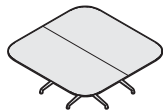
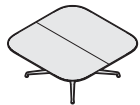

Veneer direction



For Canadian Pricing
Multiply U.S. Price by the Canadian price factor.

► See page 1 for details.

Specification Information

Dimensions			Style Number	# of (optional) Tablets	U.S. Base Prices					Corian	Glass	
L	W	H			Laminate Grade 1	Laminate Grade 2	Veneer Grade 1	Veneer Grade 2	Wedge Veneer Grade 1			Wedge Veneer Grade 2
Large Round												
One-Piece Top												
60" dia	26"		COWX_RND60	N.A.	\$2813	\$2912	\$3943	\$4298	\$ 6703	\$ 7035	\$ 5910	\$ 7046
Two-Piece Top												
72" dia	26"		COWX_RND72	N.A.	\$3605	\$3731	\$5184	\$5650	\$ 8812	\$ 9248	\$ 7570	\$ 9013
84" dia	26"		COWX_RND84	N.A.	\$4490	\$4647	\$6549	\$7139	\$11,134	\$11,699	\$10,776	\$12,350
96" dia	26"		COWX_RND96	N.A.	\$5626	\$5823	\$8292	\$9039	\$14,096	\$14,792	\$11,815	\$14,065

Square

42"	42"	26"	COWX_Q42	2 or 4	\$1813	\$1867	\$2592	\$2808	N.A.	N.A.	\$ 2700	\$ 3674
-----	-----	-----	----------	--------	--------	--------	--------	--------	------	------	---------	---------

Large Square

One-Piece Top												
60"	60"	26"	COWX_SQ60	N.A.	\$2895	\$2996	\$4052	\$4417	N.A.	N.A.	\$ 6074	\$ 7374
Two-Piece Top												
72"	72"	26"	COWX_SQ72	N.A.	\$3687	\$3817	\$5293	\$5769	N.A.	N.A.	\$ 7753	\$ 9340
84"	84"	26"	COWX_SQ84	8	\$4572	\$4732	\$6659	\$7258	N.A.	N.A.	\$10,941	\$12,678
96"	96"	26"	COWX_SQ96	N.A.	\$5708	\$5908	\$8401	\$9157	N.A.	N.A.	\$11,979	\$14,392

► Specification Information, continued on next page

SW_1 Low Collaborative Conference Tables *continued*

DESIGN SCOTT WILSON & MINIMAL

► Specification Information, continued from previous page

Tip: Your specification is not complete until you add the fifth letter to the style number to define top surface.

- L - Laminate top
- V - Wood veneer top
- C - Corian top
- G - Glass top

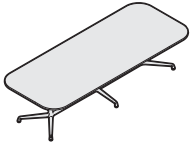

Tip: 96" L corian and glass tables require a center in-line leg as standard. The 96" L laminate and veneer tables do not require a center in-line leg for support. Refer to base matrix. ► See Coalesse Surface Materials Reference Guide.

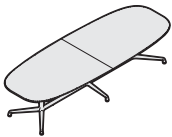

Specification Information

Dimensions			Style Number	# of (optional) Tablets	U.S. Base Prices			
L	W	H			Laminate Grade 1	Veneer Grade 1	Corian Grade 2	Glass

Rectangular

84"	42"	26"	COWX_R4284	6	\$2623	\$2802	\$3620	\$4026	\$ 6119	\$ 7200
120"	42"	26"	COWX_R4120	8	\$3652	\$3804	\$5837	\$6432	\$10,274	\$12,654

Super Elliptical

One-Piece Top

72"	40"	26"	COWX_SE4072	N.A.	\$2083	\$2170	\$3078	\$3407	\$ 5957	\$ 7038
84"	40"	26"	COWX_SE4084	N.A.	\$2678	\$2786	\$3674	\$4080	\$ 6281	\$ 7363
96"	40"	26"	COWX_SE4096	N.A.	\$3057	\$3175	\$4052	\$4539	\$ 6606	\$ 7904
120"	44"	26"	COWX_SE4120	N.A.	\$3760	\$3927	\$5946	\$6595	\$10,491	\$12,870

*Tablets are only available as an option on square tables.

Two-Piece Top

120"	44"	26"	COWX_SE4122	N.A.	\$4085	\$4252	\$6271	\$6920	\$10,815	\$13,196
------	-----	-----	-------------	------	--------	--------	--------	--------	----------	----------



For Canadian Pricing
 Multiply U.S. Price by the Canadian price factor.
 ► See page 1 for details.

SW_1 Lounge Chair & Guest Chair

DESIGN STUDIO B DESIGN ORIGIN: UNITED STATES

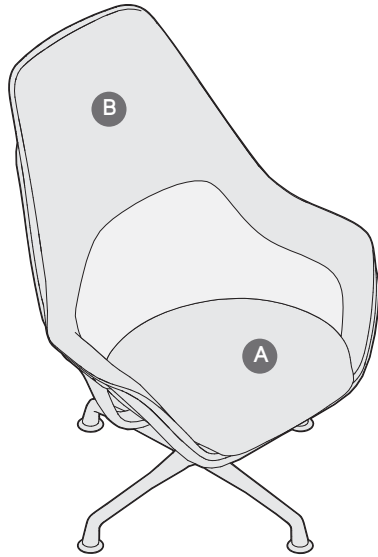

TO: _____

FROM: _____

DATE: _____

FAX....888.413.5161

A Seat: _____

B Arms/Back: _____

Contrasting fabric charges will apply. List price based on highest grade textile specified.

Specify Model below:

- COW412K Guest Chair with Glides
- COW414K Guest Chair with Casters
- COW612K Lowback Lounge Chair
- COW712K Highback Lounge Chair

For Canadian Pricing
Multiply U.S. Price by the
Canadian price factor.
▶ See page 1 for details.

Swathmore Wood Leg

DESIGN MICHAEL SHIELDS DESIGN ORIGIN: UNITED STATES

 = Available in Rapid10.

Tip: Fabrics and leathers will appear loose with comfort wrinkles when upholstered.

Tip: All cushions are attached.

Tip: Recommended leathers are Elmosoft Grade C and Elmorustical Grade E.

Tip: Special color match, consult Customer Service.

Tip: For Customer's Own Material or Leather, see necessary requirements, important processing instructions, and ordering information
 ▶ See *Coalesse Surface Materials Reference Guide*.

Standard Includes	Required to Specify
<ul style="list-style-type: none"> • Frame: unibody construction with finger jointed plywood. • Upholstery: multiple densities of polyurethane foam and polyester fiber on seat, back, and arm cushions • Legs: solid maple • Glides: 1½" dia. non-adjustable metal 	<ol style="list-style-type: none"> 1 Style number 2 Number of fabrics if contrasting fabric style number is selected 3 Fabric or leather color number for upholstery on seat, back, and arms 4 Wood color number for legs ▶ See <i>Coalesse Surface Materials Reference Guide</i> . 5 Options, if selected (see below) ▶ See <i>Coalesse Surface Materials Reference Guide</i> .

Options	U.S. Price	Required to Specify
Surface Materials <ul style="list-style-type: none"> • Contrasting fabric • Contrasting welt 	+\$113 per fabric +\$125	Add suffix K to the style number and select fabric color number. Specify with <i>contrasting welt</i> and select fabric color number.
Fire code seating <ul style="list-style-type: none"> • CAL 133 for chair • CAL 133 for two-seat sofa • CAL 133 for three-seat sofa 	+\$218 +\$437 +\$568	Specify with <i>CAL 133</i> . Specify with <i>CAL 133</i> . Specify with <i>CAL 133</i> . ▶ See <i>Coalesse Surface Materials Reference Guide</i> .
Acrylic backer <ul style="list-style-type: none"> • Backer for chair • Backer for two-seat sofa • Backer for three-seat sofa 	+\$ 35 +\$ 48 +\$ 73	Specify with <i>acrylic backer</i> . Specify with <i>acrylic backer</i> . Specify with <i>acrylic backer</i> . ▶ See <i>Coalesse Surface Materials Reference Guide</i> .
Arm Caps <ul style="list-style-type: none"> • Wood arm caps 	+\$194	Add suffix WA to the style number.

Specification Information														
Style Number	U.S. Base Prices												Leather Grades:	
	Fabric Grades:												COL	C
COM	6	7	8	9	10	11	12	13	14					

Chair with Wood Legs

	240	\$1255	\$1359	\$1417	\$1471	\$1589	\$1654	\$1700	\$1789	\$1837	\$2054	\$1526	\$2877	\$3273
COM/yds = 4, COL/sq ft = 88														

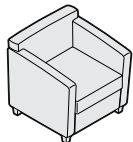

Overall: 27½"D 27"W 28½"H
 Inside: 19"D 20"W 14"H
 Seat: 17"H
 Arm: 25"H

Two-Seat Sofa with Wood Legs

	240-2	\$2177	\$2262	\$2334	\$2429	\$2564	\$2741	\$2906	\$2960	\$3037	\$3414	\$2448	\$4171	\$4662
COM/yds = 5½, COL/sq ft = 121														

▶ Specification Information, continued on next page

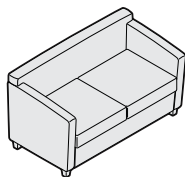

Overall: 27½"D 51"W 29"H
 Inside: 19"D 44"W 14"H
 Seat: 17"H
 Arm: 25"H

For Canadian Pricing
 Multiply U.S. Price by the Canadian price factor.
 ▶ See page 1 for details.

Coalesse

Swathmore Wood Leg

DESIGN MICHAEL SHIELDS DESIGN ORIGIN: UNITED STATES

 = Available in Rapid10.

► Specification Information, continued from previous page

Specification Information

Style Number	U.S. Base Prices											Leather Grades:		
	Fabric Grades:											COL	C	E
	COM	6	7	8	9	10	11	12	13	14				

Three-Seat Sofa with Wood Legs

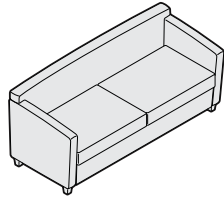

240-3	\$2749	\$2881	\$2976	\$3102	\$3278	\$3491	\$3709	\$3757	\$3855	\$4334	\$3014	\$5328	\$5872
-------	--------	--------	--------	--------	--------	--------	--------	--------	--------	--------	--------	--------	--------

COM/yds = 7, COL/sq ft = 154

Overall: 27½"D 67"W 29½"H
 Inside: 19"D 60"W 14"H
 Seat: 17"H
 Arm: 25"H

Lounge Seating



For Canadian Pricing
 Multiply U.S. Price by the
 Canadian price factor.
 ► See page 1 for details.

Swathmore Louver

DESIGN MICHAEL SHIELDS DESIGN ORIGIN: UNITED STATES

Tip: Fabrics and leathers will appear loose with comfort wrinkles when upholstered.

Tip: All cushions are attached.

Tip: Recommended leathers are Elmosoft Grade C and Elmorustical Grade E.

Tip: Special color match, consult Customer Service.

Tip: For Customer's Own Material or Leather, see necessary requirements, important processing instructions, and ordering information
 ▶ See *Coalesse Surface Materials Reference Guide*.

Standard Includes		Required to Specify	
	<ul style="list-style-type: none"> • Frame: unibody construction with finger jointed plywood. • Upholstery: multiple densities of polyurethane foam and polyester fiber on seat, back, and arm cushions • Base/legs: solid maple • Glides: 1½" dia. non-adjustable metal 		<ol style="list-style-type: none"> 1 Style number 2 Number of fabrics if contrasting fabric style number is selected 3 Fabric or leather color number for upholstery on seat, back, and arms 4 Wood color number for base ▶ See <i>Coalesse Surface Materials Reference Guide</i> . 5 Options, if selected (see below) ▶ See <i>Coalesse Surface Materials Reference Guide</i> .
Options		U.S. Price	Required to Specify
Surface Materials	• Contrasting fabric	+\$113 per fabric	Add suffix K to the style number and select fabric color number. Specify with <i>contrasting welt</i> and select fabric color number.
	• Contrasting welt	+\$125	
	Fire code seating		Specify with <i>CAL 133</i> . Specify with <i>CAL 133</i> . Specify with <i>CAL 133</i> . ▶ See <i>Coalesse Surface Materials Reference Guide</i> .
	• CAL 133 for chair	+\$218	
• CAL 133 for two-seat sofa	+\$437		
	• CAL 133 for three-seat sofa	+\$568	
	Acrylic backer		Specify with <i>acrylic backer</i> . Specify with <i>acrylic backer</i> . Specify with <i>acrylic backer</i> . ▶ See <i>Coalesse Surface Materials Reference Guide</i> .
	• Backer for chair	+\$ 35	
	• Backer for two-seat sofa	+\$ 48	
	• Backer for three-seat sofa	+\$ 73	
Arm Caps	• Wood arm caps	+\$194	Add suffix WA to the style number.

Specification Information

Style Number	U.S. Base Prices												Leather Grades:		
	Fabric Grades:												COL	C	E
COM	6	7	8	9	10	11	12	13	14						

Chair with Wood Louver Base

241	\$1800	\$1868	\$1932	\$2005	\$2111	\$2252	\$2382	\$2430	\$2495	\$2805	\$2065	\$3375	\$3789
-----	--------	--------	--------	--------	--------	--------	--------	--------	--------	--------	--------	--------	--------

COM/yds = 4, COL/sq ft = 88

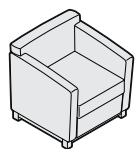

Overall: 27½"D 27"W 28½"H
 Inside: 19"D 20"W 14"H
 Seat: 17"H
 Arm: 25"H

Two-Seat Sofa with Wood Louver Base

241-2	\$2721	\$2777	\$2868	\$2960	\$3108	\$3298	\$3480	\$3528	\$3648	\$4115	\$2992	\$4852	\$5400
-------	--------	--------	--------	--------	--------	--------	--------	--------	--------	--------	--------	--------	--------

COM/yds = 5½, COL/sq ft = 121

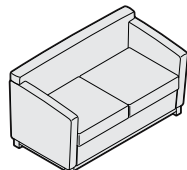

Overall: 27½"D 51"W 29"H
 Inside: 19"D 44"W 14"H
 Seat: 17"H
 Arm: 25"H

▶ Specification Information, continued on next page

Coalesse

Swathmore Louver

DESIGN MICHAEL SHIELDS DESIGN ORIGIN: UNITED STATES

► Specification Information, continued from previous page

Specification Information

Style Number	U.S. Base Prices											Leather Grades:		
	Fabric Grades:											COL	C	E
	COM	6	7	8	9	10	11	12	13	14				

Three-Seat Sofa with Wood Louver Base

241-3	\$3535	\$3614	\$3780	\$3911	\$4159	\$4395	\$4643	\$4697	\$4840	\$5452	\$3801	\$6388	\$6954
-------	--------	--------	--------	--------	--------	--------	--------	--------	--------	--------	--------	--------	--------

COM/yds = 7, COL/sq ft = 154

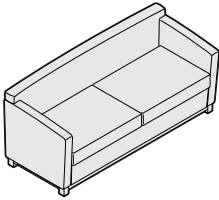

Overall: 27½"D 67"W 29½"H
 Inside: 19"D 60"W 14"H
 Seat: 17"H
 Arm: 25"H

Lounge Seating



For Canadian Pricing
 Multiply U.S. Price by the
 Canadian price factor.
 ► See page 1 for details.

Swathmore Grande Wood Leg

DESIGN MICHAEL SHIELDS DESIGN ORIGIN: UNITED STATES

 = Available in Rapid10.

Tip: Fabrics and leathers will appear loose with comfort wrinkles when upholstered.

Tip: All cushions are attached.

Tip: Recommended leathers are Elmosoft Grade C and Elmorustical Grade E.

Tip: Special color match, consult customer service.

Tip: For Customer's Own Material or Leather, see necessary requirements, important processing instructions, and ordering information
▶ See *Coalesse Surface Materials Reference Guide*.

Tip: Tablet not available on wood armcap models.

Tip: Tablet worksurface is 21⁵/₈" x 11⁵/₈".

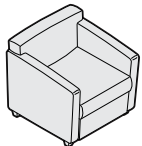

Overall: 30"D 30"W 29¹/₂"H
Inside: 20"D 21³/₄"W 15"H
Seat: 16³/₄"H
Arm: 24"H



For Canadian Pricing
Multiply U.S. Price by the Canadian price factor.
▶ See page 1 for details.

Standard Includes		Required to Specify	
	<ul style="list-style-type: none"> • Frame: unibody construction with finger jointed plywood • Upholstery: multiple densities of polyurethane foam and polyester fiber on seat, back, and arm cushions • Legs: solid maple • Glides: 1¹/₈" dia. non-adjustable metal 		<ol style="list-style-type: none"> 1 Style number 2 Number of fabrics if contrasting fabric style number is selected 3 Fabric or leather color number for upholstery on seat, back, and arms 4 Wood color number for legs ▶ See <i>Coalesse Surface Materials Reference Guide</i> . 5 Options, if selected (see below) ▶ See <i>Coalesse Surface Materials Reference Guide</i> .
Options		U.S. Price	Required to Specify
Surface Materials	• Contrasting fabric	+\$113 per fabric	Add suffix K to the style number and select fabric color number.
	• Contrasting welt	+\$125	Specify with <i>contrasting welt</i> and select fabric color number.
	Fire code seating		
	• CAL 133 for chair	+\$218	Specify with <i>CAL 133</i> .
	• CAL 133 for two-seat sofa	+\$437	Specify with <i>CAL 133</i> .
	• CAL 133 for three-seat sofa	+\$568	Specify with <i>CAL 133</i> .
	• CAL 133 for 30"W bariatric chair	+\$285	Specify with <i>CAL 133</i> .
	• CAL 133 for 40"W bariatric chair	+\$313	Specify with <i>CAL 133</i> .
	Acrylic backer		
	• Backer for chair	+\$ 44	Specify with <i>acrylic backer</i> .
	• Backer for two-seat sofa	+\$ 58	Specify with <i>acrylic backer</i> .
	• Backer for three-seat sofa	+\$ 73	Specify with <i>acrylic backer</i> .
	• Backer for 30"W bariatric chair	+\$ 52	Specify with <i>acrylic backer</i> .
	• Backer for 40"W bariatric chair	+\$ 60	Specify with <i>acrylic backer</i> .
			▶ See <i>Coalesse Surface Materials Reference Guide</i> .
Arm Caps	• Wood arm caps	+\$194	Add suffix WA to the style number.
Tablet (243 only)	• Laminate tablet	+\$302	Specify with <i>laminate tablet</i> .
	• Wood tablet	+\$513	Specify with <i>wood tablet</i> .

Specification Information															
Style Number	U.S. Base Prices												Leather Grades:		
	Fabric Grades:												COL	C	E
COM	6	7	8	9	10	11	12	13	14						

Chair with Wood Legs

 243	\$1668	\$1778	\$1843	\$1921	\$2097	\$2240	\$2381	\$2469	\$2518	\$2813	\$1934	\$3373	\$3799
COM/yds = 5, COL/sq ft = 110													

▶ Specification Information, continued on next page

Swathmore Grande Wood Leg

DESIGN MICHAEL SHIELDS DESIGN ORIGIN: UNITED STATES

 = Available in Rapid10.

► Specification Information, continued from previous page

Specification Information

Style Number	U.S. Base Prices													
	Fabric Grades:											Leather Grades:		
	COM	6	7	8	9	10	11	12	13	14	COL	C	E	

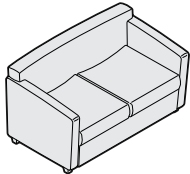

Overall: 30"D 54"W 30"H
 Inside: 20"D 45¼"W 15"H
 Seat: 16¾"H
 Arm: 24"H

Two-Seat Sofa with Wood Legs														
 243-2	\$2473	\$2572	\$2666	\$2772	\$2932	\$3119	\$3322	\$3374	\$3462	\$3891	\$2751	\$4923	\$5318	
COM/yds = 6½, COL/sq ft = 143														

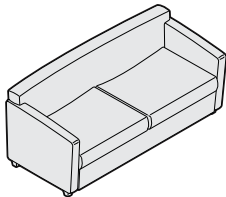

Overall: 30"D 70"W 30½"H
 Inside: 20"D 61¾"W 15"H
 Seat: 16¾"H
 Arm: 24"H

Three-Seat Sofa with Wood Legs														
 243-3	\$3128	\$3291	\$3403	\$3540	\$3734	\$3988	\$4230	\$4283	\$4386	\$4929	\$3400	\$6097	\$6694	
COM/yds = 8, COL/sq ft = 176														

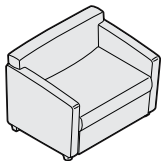

Overall: 30"D 38¼"W 29½"H
 Inside: 20"D 30"W 15"H
 Seat: 16¾"H
 Arm: 24"H

Chair with Wood Legs—Bariatric with 30" Large Scale

243B-30	\$2065	\$2222	\$2287	\$2334	\$2418	\$2505	\$2658	\$2812	\$2968	\$3328	\$2343	\$5217	\$5737	
COM/yds = 6, COL/sq ft = 127														

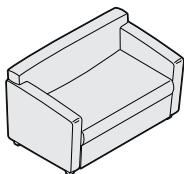

Overall: 30"D 48¼"W 29½"H
 Inside: 20"D 40"W 15"H
 Seat: 16¾"H
 Arm: 24"H

Chair with Wood Legs—Bariatric with 40" Large Scale

243B-40	\$2342	\$2517	\$2594	\$2634	\$2748	\$2829	\$3008	\$3184	\$3358	\$3767	\$2607	\$5873	\$6445	
COM/yds = 6½, COL/sq ft = 143														

For Canadian Pricing
 Multiply U.S. Price by the
 Canadian price factor.
 ► See page 1 for details.

Swathmore Grande Louver

DESIGN MICHAEL SHIELDS DESIGN ORIGIN: UNITED STATES

Tip: Fabrics and leathers will appear loose with comfort wrinkles when upholstered.

Tip: All cushions are attached.

Tip: Recommended leathers are Elmosoft Grade C and Elmorustical Grade E.

Tip: Special color match, consult Customer Service.

Tip: For Customer's Own Material or Leather, see necessary requirements, important processing instructions, and ordering information
 ▶ See *Coalesse Surface Materials Reference Guide*.

Standard Includes	Required to Specify
<ul style="list-style-type: none"> • Frame: unibody construction with finger jointed plywood • Upholstery: multiple densities of polyurethane foam and polyester fiber on seat, back, and arm cushions • Legs: solid maple • Glides: 1½" dia. non-adjustable metal 	<ol style="list-style-type: none"> 1 Style number 2 Number of fabrics if contrasting fabric style number is selected 3 Fabric or leather color number for upholstery on seat, back, and arms 4 Wood color number for frame and legs ▶ See <i>Coalesse Surface Materials Reference Guide</i> . 5 Options, if selected (see below) ▶ See <i>Coalesse Surface Materials Reference Guide</i> .

Options	U.S. Price	Required to Specify
Surface Materials <ul style="list-style-type: none"> • Contrasting fabric • Contrasting welt 	+\$113 per fabric +\$125	Add suffix K to the style number and select fabric color number. Specify with <i>contrasting welt</i> and select fabric color number.
Fire code seating <ul style="list-style-type: none"> • CAL 133 for chair • CAL 133 for two-seat sofa • CAL 133 for three-seat sofa 	+\$218 +\$437 +\$568	Specify with <i>CAL 133</i> . Specify with <i>CAL 133</i> . Specify with <i>CAL 133</i> . ▶ See <i>Coalesse Surface Materials Reference Guide</i> .
Acrylic backer <ul style="list-style-type: none"> • Backer for chair • Backer for two-seat sofa • Backer for three-seat sofa 	+\$ 44 +\$ 58 +\$ 73	Specify with <i>acrylic backer</i> . Specify with <i>acrylic backer</i> . Specify with <i>acrylic backer</i> . ▶ See <i>Coalesse Surface Materials Reference Guide</i> .
Arm Caps <ul style="list-style-type: none"> • Wood arm caps 	+\$194	Add suffix WA to the style number.

Specification Information														
Style Number	U.S. Base Prices												Leather Grades:	
	Fabric Grades:												COL	C
COM	6	7	8	9	10	11	12	13	14					

Chair with Wood Louver

244	\$2283	\$2377	\$2430	\$2522	\$2647	\$2796	\$2954	\$3008	\$3101	\$3493	\$2555	\$4112	\$4554
-----	--------	--------	--------	--------	--------	--------	--------	--------	--------	--------	--------	--------	--------

COM/yds = 5, COL/sq ft = 110

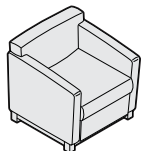

Overall: 30"D 30"W 29½"H
 Inside: 20"D 21¾"W 15"H
 Seat: 16¾"H
 Arm: 24"H

Two-Seat Sofa with Wood Louver

244-2	\$3258	\$3343	\$3433	\$3550	\$3723	\$3929	\$4147	\$4195	\$4340	\$4901	\$3535	\$5730	\$6322
-------	--------	--------	--------	--------	--------	--------	--------	--------	--------	--------	--------	--------	--------

COM/yds = 6½, COL/sq ft = 143

▶ Specification Information, continued on next page

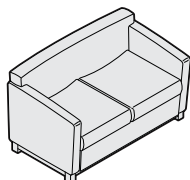

Overall: 30"D 54"W 30"H
 Inside: 20"D 45¾"W 15"H
 Seat: 16¾"H
 Arm: 24"H

 **For Canadian Pricing**
 Multiply U.S. Price by the Canadian price factor.
 ▶ See page 1 for details.

Swathmore Grande Louver

DESIGN MICHAEL SHIELDS DESIGN ORIGIN: UNITED STATES

► Specification Information, continued from previous page

Specification Information

Style Number	U.S. Base Prices											Leather Grades:		
	Fabric Grades:											COL	C	E
	COM	6	7	8	9	10	11	12	13	14				

Three-Seat Sofa with Wood Louver

244-3	\$3772	\$3871	\$4053	\$4206	\$4502	\$4773	\$5040	\$5117	\$5251	\$5908	\$4044	\$7050	\$7675
-------	--------	--------	--------	--------	--------	--------	--------	--------	--------	--------	--------	--------	--------

COM/yds = 8, COL/sq ft = 176

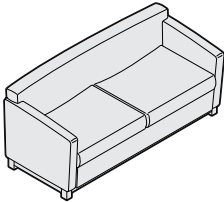

Overall: 30"D 70"W 30½"H
 Inside: 20"D 61¾"W 15"H
 Seat: 16¾"H
 Arm: 24"H

Lounge Seating



For Canadian Pricing
 Multiply U.S. Price by the
 Canadian price factor.
 ► See page 1 for details.

Swathmore Grande Mobile

DESIGN MICHAEL SHIELDS DESIGN ORIGIN: UNITED STATES

 = Available in Rapid10.

Tip: Fabrics and leathers will appear loose with comfort wrinkles when upholstered.

Tip: Soft casters are not available.

Tip: Wilsonart standard laminate colors.

► See *Coalesse Surface Materials Reference Guide*.

Tip: Recommended leathers are Elmosoft Grade C and Elmorustical Grade E.

Tip: Special color match, consult Customer Service.

Tip: For Customer's Own Material or Leather, see necessary requirements, important processing instructions, and ordering information

► See *Coalesse Surface Materials Reference Guide*.

Tip: Tablet worksurface is 21⁵/₈" x 11⁵/₈".

Standard Includes	Required to Specify
<ul style="list-style-type: none"> • Frame: unibody construction with finger jointed plywood • Hard casters: rear locking • Steel push handle: black • Pivoting worksurface tablet: laminate 	<ol style="list-style-type: none"> 1 Style number 2 Number of fabrics if contrasting fabric style number is selected 3 Fabric or leather color number for upholstery on seat, back, and arms 4 Laminate color for tablet 5 Options, if selected (see below) <p>► See <i>Coalesse Surface Materials Reference Guide</i>.</p>

	Options	U.S. Price	Required to Specify
Surface Materials	• Contrasting fabric	+\$113 per fabric	Add suffix K to the style number and select fabric color number.
	• Contrasting welt	+\$125	Specify with <i>contrasting welt</i> and select fabric color number.
	Fire code seating		
	• CAL 133	+\$218	Specify with <i>CAL 133</i> . ► See <i>Coalesse Surface Materials Reference Guide</i> .
	Acrylic backer		
	• Backer	+\$ 44	Specify with <i>acrylic backer</i> . ► See <i>Coalesse Surface Materials Reference Guide</i> .
Tablet	• Omit tablet	-\$226	Specify with <i>omit tablet</i> .
	• Wood tablet	+\$256	Specify with <i>wood tablet</i> .
Omit Push Handle	• Omit push handle	-\$ 28	Specify with <i>omit push handle</i> .

Specification Information														
Style Number	U.S. Base Prices											Leather Grades:		
	Fabric Grades:											COL	C	E
COM	6	7	8	9	10	11	12	13	14					

Chair with Tablet Left Facing

	243MTL	\$2148	\$2246	\$2305	\$2400	\$2599	\$2759	\$2925	\$3008	\$3087	\$3463	\$2419	\$4064	\$4520
---	---------------	--------	--------	--------	--------	--------	--------	--------	--------	--------	--------	--------	--------	--------

COM/yds = 5, COL/sq ft = 110

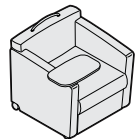

Overall: 30"D 30"W 29½"H
 Inside: 20"D 21¾"W 15"H
 Seat: 16¾"H
 Arm: 24"H

Chair with Tablet Right Facing

	243MTR	\$2148	\$2246	\$2305	\$2400	\$2599	\$2759	\$2925	\$3008	\$3087	\$3463	\$2419	\$4064	\$4520
---	---------------	--------	--------	--------	--------	--------	--------	--------	--------	--------	--------	--------	--------	--------

COM/yds = 5, COL/sq ft = 110

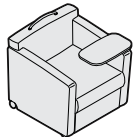

Overall: 30"D 30"W 29½"H
 Inside: 20"D 21¾"W 15"H
 Seat: 16¾"H
 Arm: 24"H



For Canadian Pricing
 Multiply U.S. Price by the Canadian price factor.
 ► See page 1 for details.

Coalesse

Swathmore Grande Mobile

DESIGN MICHAEL SHIELDS DESIGN ORIGIN: UNITED STATES

Switch

DESIGN EOOS DESIGN ORIGIN: GERMANY

Tip: Fabrics and leathers will appear loose with comfort wrinkles when upholstered.

Tip: Due to seat conversion arms are 4 1/2"W. Lowered arm has weight limit of 500 lb.

Tip: Recommended leathers are Elmosoft Grade C and Elmorustical Grade E.

► For multi-fabric diagram, see page 210.

Tip: Loose cushions standard.

Tip: Arm bolsters must be specified separately.

Tip: Special color match, consult Customer Service.

Tip: For Customer's Own Material or Leather, see necessary requirements, important processing instructions, and ordering information
► See Coalesse Surface Materials Reference Guide.

Tip: 391-4 two seat with extensions, when extended: Both arms = 96"W overall One arm = 84"W overall Arms not extended = 71"W overall (closed).



Overall: 29 1/2"D 28"W 32 1/2"H
Inside: 19"D 20"W 17"H
Seat: 17 1/2"H
Arm: 26"H

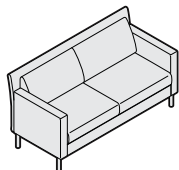

Overall: 29 1/2"D 63"W 32 1/2"H
Inside: 19"D 55"W 17"H
Seat: 17 1/2"H
Arm: 26"H

Standard Includes		Required to Specify	
	<ul style="list-style-type: none"> Selected solid hardwood and wood veneer frame Two seat with extension: tubular steel frame with solid hardwood arms <ul style="list-style-type: none"> Arms are 4.5" wide Upholstery: multiple densities of polyurethane foam and polyester fiber on seat back and arms Legs: trivalent matte chrome finish on steel Arm bolster, if selected: fabric or leather 		<ol style="list-style-type: none"> Style number Number of fabrics if contrasting fabric style number is selected Fabric or leather color number for upholstery on seat, back, and arms, or arm bolsters, if selected Options, if selected (see below) ► See Coalesse Surface Materials Reference Guide.
Options		U.S. Price	Required to Specify
Surface Materials	<ul style="list-style-type: none"> Contrasting fabric 	+\$113 per fabric	Add suffix K to the style number and select fabric color number.
	Fire code seating		
	<ul style="list-style-type: none"> CAL 133 for chair CAL 133 for two-seat chair CAL 133 for three-seat chair and two-seat chair with extensions 	+\$218 +\$437 +\$568	Specify with CAL 133. Specify with CAL 133. Specify with CAL 133. ► See Coalesse Surface Materials Reference Guide.
	Acrylic backer		
	<ul style="list-style-type: none"> Backer for chair Backer for two-seat chair Backer for three-seat chair Backer for two-seat chair with extensions Backer for arm bolster 	+\$ 39 +\$ 69 +\$ 73 +\$ 87 +\$ 8	Specify with acrylic backer. Specify with acrylic backer. Specify with acrylic backer. Specify with acrylic backer. Specify with acrylic backer. ► See Coalesse Surface Materials Reference Guide.
Attachment Straps	<ul style="list-style-type: none"> Attachment straps for 391 Attachment straps for 391-2 Attachment straps for 391-3 Attachment straps for 391-4 Attachment straps for bolster 	+\$118 +\$236 +\$354 +\$236 +\$ 59	Specify with attachment straps. Specify with attachment straps. Specify with attachment straps. Specify with attachment straps. Specify with attachment straps.

Specification Information

Style Number	U.S. Base Prices										Leather Grades:		
	Fabric Grades:										COL	C	E
	COM	6	7	8	9	10	11	12	13	14			

Chair

391	\$1935	\$2220	\$2260	\$2334	\$2573	\$2856	\$3096	\$3323	\$3404	\$3501	\$2196	\$4674	\$5333
COM/yds = 4 1/2, COL/sq ft = 99													

Two-Seat

391-2	\$3009	\$3488	\$3567	\$3687	\$3966	\$4420	\$4806	\$5112	\$5225	\$5388	\$3271	\$7294	\$8247
COM/yds = 7 1/2, COL/sq ft = 165													

► Specification Information, continued on next page

Switch

DESIGN EOOS DESIGN ORIGIN: GERMANY

► Specification Information, continued from previous page

Specification Information

Style Number	U.S. Base Prices										Leather Grades:		
	Fabric Grades:										COL	C	E
	COM	6	7	8	9	10	11	12	13	14			

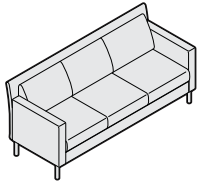

Overall: 29½"D 73½"W 32½"H
 Inside: 19"D 65½"W 17"H
 Seat: 17½"H
 Arm: 26"H

Three-Seat

391-3	\$3946	\$4607	\$4697	\$4857	\$5226	\$5839	\$6357	\$6755	\$6903	\$7115	\$4208	\$ 9588	\$10,787
-------	--------	--------	--------	--------	--------	--------	--------	--------	--------	--------	--------	---------	----------

COM/yds = 8, COL/sq ft = 176

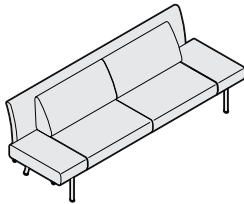

Sofa overall: 19"D 59"W 32½"H
 Overall extended: 33½"D 96"W 32½"H
 Sofa with one arm extended overall:
 19"D 77½"W 32½"H
 Seat: 17½"H
 Arm: 17½"H
 Both Arms Up: 59"
 One Arm Up: 77½"H

Two-Seat with Extensions

391-4	\$4151	\$4908	\$5011	\$5198	\$5620	\$6329	\$6903	\$7369	\$7507	\$7707	\$4413	\$10,573	\$11,913
-------	--------	--------	--------	--------	--------	--------	--------	--------	--------	--------	--------	----------	----------

COM/yds = 9, COL/sq ft = 198



Overall: 17½"D 5¾"Dia

Arm Bolster

391-B	\$ 208	\$ 226	\$ 232	\$ 243	\$ 267	\$ 312	\$ 346	\$ 375	\$ 387	\$ 388	\$ 475	\$ 748	\$ 1005
-------	--------	--------	--------	--------	--------	--------	--------	--------	--------	--------	--------	--------	---------

COM/yds = 1, COL/sq ft = 18

Lounge Seating

 **For Canadian Pricing**
 Multiply U.S. Price by the
 Canadian price factor.
 ► See page 1 for details.

Switch Multi-Fabric Diagram

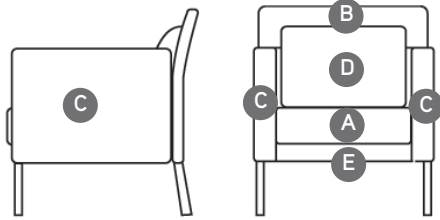

Model 391 Shown Above

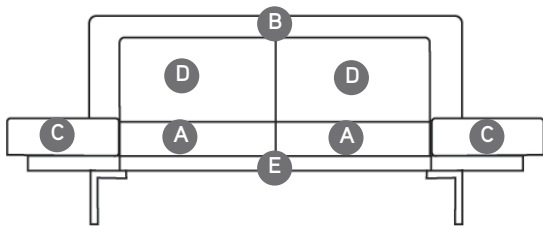

Model 391-4 Shown Above

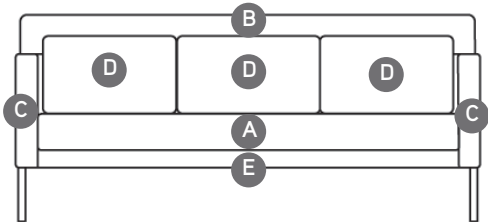

391-3 Shown Above

TO: _____

FROM: _____

DATE: _____

FAX....888.413.5161

A Seat (upholstery selections default for entire unit if B is not selected): _____

B Back: _____

C Arms: _____

D Back Cushion: _____

E Base Frame: _____

***Due to soft nature of loose cushions, genuine leathers are recommended. All other textiles must be submitted for pre-approval.**

Tip: Arm bolsters must be specified separately.

*\$113 U.S. list per contrasting fabric specified. List price based on highest fabric grade usage.

Specify Model below:

391K Switch Chair

391-2K Switch Two Seat Sofa (not shown)

391-3K Switch Three Seat Sofa

391-4K Switch Two Seat with Extension



For Canadian Pricing
 Multiply U.S. Price by the
 Canadian price factor.
 ▶ See page 1 for details.

Coalesse

Switch Multi-Fabric Diagram

Thoughtful Lounge

DESIGN PAMELA LIGHT, FIIDA SHIELDS DESIGN ORIGIN: UNITED STATES

Tip: Fabrics and leathers will appear loose with comfort wrinkles when upholstered.

Tip: All polyurethane foam meets CAL-117 specifications.

Tip: Pricing based on highest grade textile specified.

Tip: Seats will always have some comfort wrinkles. The amount of wrinkles will vary depending on the fabric.

Tip: Welting COM yardage required = 1/2 yards or 22 square feet.

Tip: Recommended leathers are Elmosoft Grade C and Elmorustical Grade E.

Tip: Special color match, consult customer service.

Tip: For Customer's Own Material or Leather, see necessary requirements, important processing instructions, and ordering information
 ▶ See Coalesse Surface Materials Reference Guide.

Standard Includes	Required to Specify
<ul style="list-style-type: none"> • Frame: unibody construction with finger jointed plywood • Legs: maple or walnut wood • Upholstery: multiple densities of polyurethane foam • Double needle stitch on seams 	<ol style="list-style-type: none"> 1 Style number 2 Number of fabrics if contrasting fabric style number is selected 3 Fabric or leather color number for upholstery on seat and back 4 Wood species 5 Wood color number for legs 6 Options, if selected (see below) ▶ See Coalesse Surface Materials Reference Guide. ▶ See Coalesse Surface Materials Reference Guide.

Options	U.S. Price	Required to Specify
Surface Materials <ul style="list-style-type: none"> • Contrasting fabric • Contrasting welt for welting around base of chair 	+\$113 per fabric +\$170	Add suffix K to the style number and select fabric color number. Specify with contrasting welt and select fabric color number.
Fire code seating <ul style="list-style-type: none"> • CAL 133 for chair • CAL 133 for two-seat sofa • CAL 133 for three-seat sofa • CAL 133 for ottoman 	+\$218 +\$437 +\$568 +\$218	Specify with CAL 133. Specify with CAL 133. Specify with CAL 133. Specify with CAL 133. ▶ See Coalesse Surface Materials Reference Guide.
Acrylic backer <ul style="list-style-type: none"> • Backer for lounge chair • Backer for small sofa • Backer for medium sofa • Backer for long sofa • Backer for ottoman 	+\$ 48 +\$ 91 +\$100 +\$110 +\$ 23	Specify with acrylic backer. Specify with acrylic backer. Specify with acrylic backer. Specify with acrylic backer. Specify with acrylic backer. ▶ See Coalesse Surface Materials Reference Guide.

Style Number	U.S. Base Prices											Leather Grades:		
	COM	6	7	8	9	10	11	12	13	14	COL	C	E	

Lounge Chair

385	\$1816	\$1963	\$2021	\$2055	\$2150	\$2228	\$2446	\$2594	\$2685	\$3008	\$2081	\$4839	\$5328
COM/yds = 5 1/2, COL/sq ft = 121													

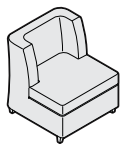

Overall: 29 3/4"D 28 3/4"W 32"H
 Inside: 20"D 21 1/2"W 14 1/2"H
 Seat: 17 1/2"H

Small Sofa

385-60	\$3389	\$3688	\$3801	\$3889	\$4060	\$4201	\$4627	\$4904	\$5076	\$5684	\$3655	\$8941	\$9880
COM/yds = 10 1/2, COL/sq ft = 231													

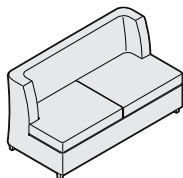

Overall: 30 1/4"D 60 3/4"W 32"H
 Inside: 20 1/4"D 53 1/2"W 14 1/2"H
 Seat: 17 1/2"H

▶ Specification Information, continued on next page



For Canadian Pricing
 Multiply U.S. Price by the Canadian price factor.
 ▶ See page 1 for details.

Thoughtful Lounge

DESIGN PAMELA LIGHT, FIIDA SHIELDS DESIGN ORIGIN: UNITED STATES

► Specification Information, continued from previous page

Specification Information

Style Number	U.S. Base Prices													
	Fabric Grades:											Leather Grades:		
	COM	6	7	8	9	10	11	12	13	14	COL	C	E	

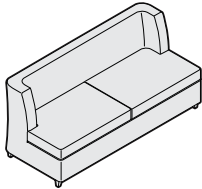

Overall: 30¾"D 70¾"W 32"H
 Inside: 20½"D 63½"W 14½"H
 Seat: 17½"H

Medium Sofa

385-70	\$4533	\$4879	\$5003	\$5091	\$5280	\$5434	\$5895	\$6215	\$6395	\$7253	\$4811	\$10,592	\$11,626
--------	--------	--------	--------	--------	--------	--------	--------	--------	--------	--------	--------	----------	----------

COM/yds = 11½, COL/sq ft = 253

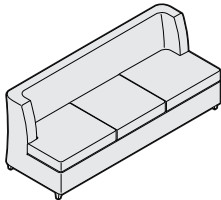

Overall: 31¼"D 80¾"W 32"H
 Inside: 20¾"D 73½"W 14½"H
 Seat: 17½"H

Long Sofa

385-80	\$4770	\$5139	\$5288	\$5387	\$5600	\$5760	\$6284	\$6634	\$6827	\$7673	\$5041	\$11,473	\$12,612
--------	--------	--------	--------	--------	--------	--------	--------	--------	--------	--------	--------	----------	----------

COM/yds = 12¾, COL/sq ft = 281

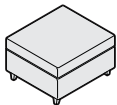

Overall: 26¼"D 28½"W 17¾"H

Ottoman

385-H	\$1358	\$1414	\$1443	\$1467	\$1510	\$1551	\$1664	\$1734	\$1774	\$2001	\$1630	\$ 2998	\$ 3240
-------	--------	--------	--------	--------	--------	--------	--------	--------	--------	--------	--------	---------	---------

COM/yds = 2¾, COL/sq ft = 61



For Canadian Pricing
 Multiply U.S. Price by the
 Canadian price factor.
 ► See page 1 for details.

Thoughtful Multi-Fabric Diagram

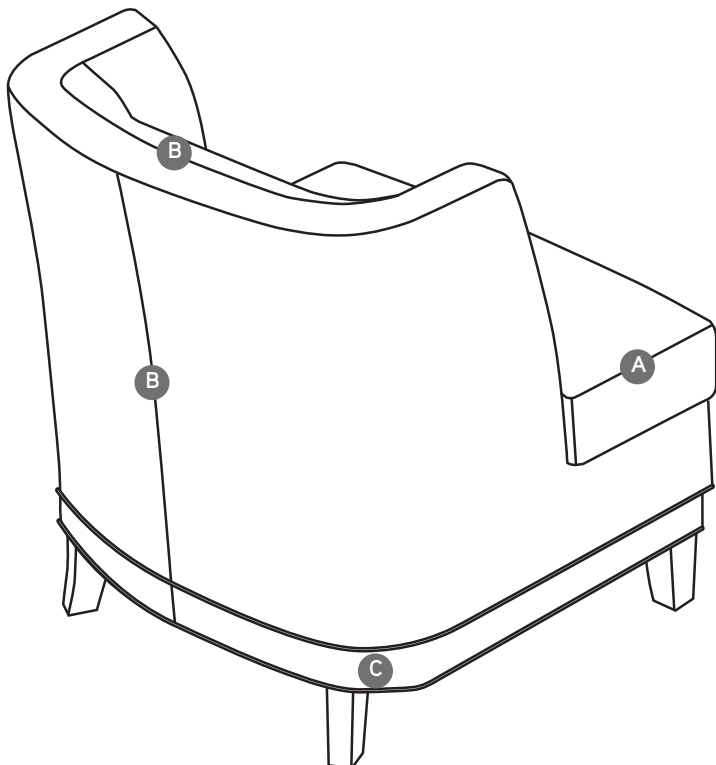
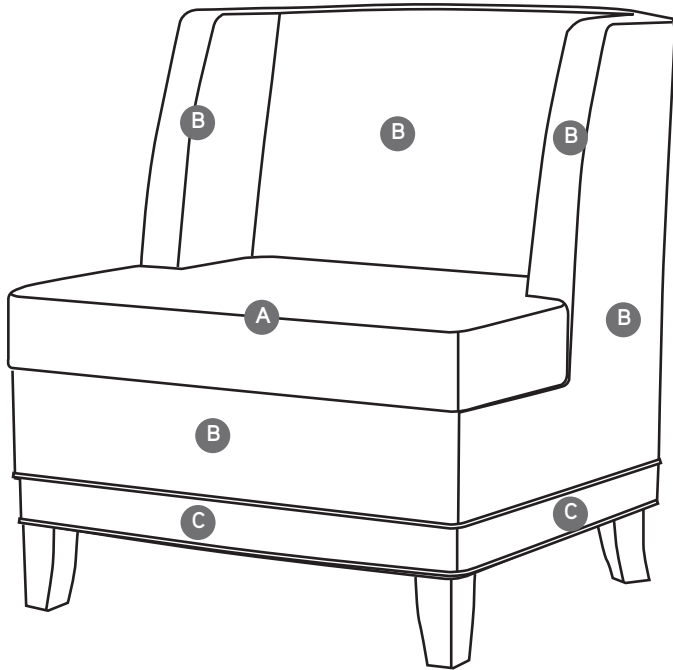

TO: _____
 FROM: _____
 DATE: _____
 FAX...888.413.5161

- A** Seat (default for entire unit if B is not selected): _____
- B** Arms and Back: _____
- C** Base Frame: _____

Please indicate which model:

- 385K
- 385-60K
- 385-70K
- 385-80K

Total list price upcharge for contrasting fabrics:
 \$ _____

*\$113 U.S. list per contrasting fabric specified. List price based on highest fabric grade usage.

*Contrasting welt offered as a separate option \$164 upcharge.

Coalesse

Thoughtful Multi-Fabric Diagram

Together Bench by Walter Knoll

DESIGN EOOS DESIGN ORIGIN: 2004 GERMANY

Tip: Fabrics and leathers will appear loose with comfort wrinkles when upholstered.

▶ See page 222 for multi-fabric diagram.

▶ See page 223 for offset diagram.

Tip: For Customer's Own Material or Leather, see necessary requirements, important processing instructions, and ordering information

▶ See *Coalesse Surface Materials Reference Guide*.

Standard Includes		Required to Specify	
	<ul style="list-style-type: none"> Upholstery for chair: fabric or leather Glides 		1 Style number 2 Number of fabrics if contrasting fabric style number is selected 3 Fabric or leather color number for upholstery 4 Options, if selected (see below) ▶ See <i>Coalesse Surface Materials Reference Guide</i> .
Options		U.S. Price	Required to Specify
Surface Materials	• Contrasting Fabric	+\$113 per fabric	Add suffix K to the style number and select fabric color number.
	Fire code seating		
	• CAL 133	+\$568	Specify with CAL 133. ▶ See <i>Coalesse Surface Materials Reference Guide</i> .
	Acrylic backer		
	• Backer for 69¾"W straight bench without back	+\$ 33	Specify with acrylic backer.
	• Backer for 96½"W straight bench without back	+\$ 37	Specify with acrylic backer.
	• Backer for 26¾"D x 69¾"W benches	+\$ 46	Specify with acrylic backer.
	• Backer for 26¾"D x 96½"W benches	+\$ 56	Specify with acrylic backer.
	• Backer for 69¾"D x 96½"W benches	+\$ 89	Specify with acrylic backer.
	• Backer for 96½"D x 96½"W and 69¾"D x 123¼"W benches	+\$100	Specify with acrylic backer.
• Backer for 96½"D x 123¼"W bench	+\$110	Specify with acrylic backer. ▶ See <i>Coalesse Surface Materials Reference Guide</i> .	
Back Offset	• Back offset	No cost	Specify with back offset.

Specification Information													
Style Number	U.S. Base Prices												
	Fabric Grades:										Leather Grades:		
	COM	6	7	8	9	10	11	12	13	14	COL	C	E

Left Corner with Back, 8" Offset

COTO9669L8	\$6617	\$6832	\$6916	\$6980	\$7105	\$7211	\$7528	\$7739	\$8200	\$8826	\$6833	\$10,741	\$11,437
COM/yds = 9¾, COL/sq ft = 215													

COTO9696L8	\$7137	\$7377	\$7471	\$7542	\$7681	\$7797	\$8147	\$8379	\$8885	\$9551	\$7353	\$11,667	\$12,434
COM/yds = 10¾, COL/sq ft = 237													

▶ Specification Information, continued on next page

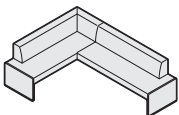

Overall: 69¾"D 96½"W 31"H
Seat: 19"D 18½"H

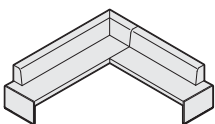

Overall: 96½"D 96½"W 31"H
Seat: 19"D 18½"H



For Canadian Pricing
Multiply U.S. Price by the Canadian price factor.

▶ See page 1 for details.

Together Bench by Walter Knoll

DESIGN EOOS DESIGN ORIGIN: 2004 GERMANY

► See page 223 for offset diagram.

► Specification Information, continued from previous page

Specification Information

Style Number	U.S. Base Prices													
	Fabric Grades:											Leather Grades:		
	COM	6	7	8	9	10	11	12	13	14	COL	C	E	

Left Corner with Back, 8" Offset, continued

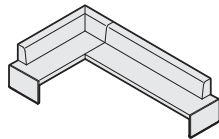

Overall: 69¾"D 123¼"W 31"H
Seat: 19"D 18½"H

COT012369L8	\$7341	\$7596	\$7692	\$7766	\$7913	\$8033	\$8400	\$8643	\$9173	\$ 9856	\$7557	\$12,073	\$12,875
-------------	--------	--------	--------	--------	--------	--------	--------	--------	--------	---------	--------	----------	----------

COM/yds = 11¼, COL/sq ft = 248

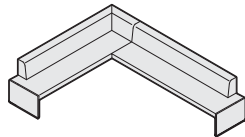

Overall: 96½"D 123¼"W 31"H
Seat: 19"D 18½"H

COT012396L8	\$7715	\$7995	\$8101	\$8182	\$8341	\$8472	\$8870	\$9136	\$9713	\$10,435	\$7931	\$12,850	\$13,726
-------------	--------	--------	--------	--------	--------	--------	--------	--------	--------	----------	--------	----------	----------

COM/yds = 12½, COL/sq ft = 270

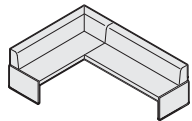

Overall: 69¾"D 96½"W 31"H
Seat: 19"D 18½"H

Left Corner with Back, 1½" Offset

COT09669L15	\$6758	\$6986	\$7075	\$7142	\$7276	\$7386	\$7719	\$7940	\$8423	\$ 9069	\$6974	\$11,085	\$11,816
-------------	--------	--------	--------	--------	--------	--------	--------	--------	--------	---------	--------	----------	----------

COM/yds = 10¼, COL/sq ft = 226

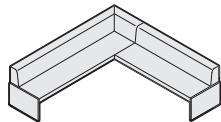

Overall: 96½"D 96½"W 31"H
Seat: 19"D 18½"H

COT09696L15	\$7279	\$7534	\$7630	\$7704	\$7851	\$7971	\$8338	\$8581	\$9111	\$ 9794	\$7495	\$12,011	\$12,813
-------------	--------	--------	--------	--------	--------	--------	--------	--------	--------	---------	--------	----------	----------

COM/yds = 11¼, COL/sq ft = 248

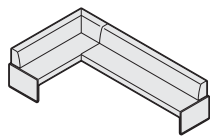

Overall: 69¾"D 123¼"W 31"H
Seat: 19"D 18½"H

COT012369L15	\$7482	\$7749	\$7851	\$7927	\$8080	\$8207	\$8588	\$8843	\$9397	\$10,099	\$7698	\$12,417	\$13,255
--------------	--------	--------	--------	--------	--------	--------	--------	--------	--------	----------	--------	----------	----------

COM/yds = 11¾, COL/sq ft = 259

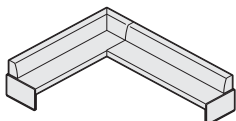

Overall: 96½"D 123¼"W 31"H
Seat: 19"D 18½"H

COT012396L15	\$7854	\$8146	\$8257	\$8340	\$8507	\$8644	\$9058	\$9334	\$9935	\$10,676	\$8070	\$13,192	\$14,102
--------------	--------	--------	--------	--------	--------	--------	--------	--------	--------	----------	--------	----------	----------

COM/yds = 12¾, COL/sq ft = 281

► Specification Information, continued on next page

Together Bench by Walter Knoll *continued*

DESIGN EOOS DESIGN ORIGIN: 2004 GERMANY

Tip: For Customer's Own Material or Leather, see necessary requirements, important processing instructions, and ordering information
 ▶ See *Coalesse Surface Materials Reference Guide*.

Tip: Fabrics and leathers will appear loose with comfort wrinkles when upholstered.

▶ See page 223 for offset diagram.

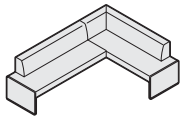

Overall: 69¼"D 96½"W 31"H
 Seat: 19"D 18½"H

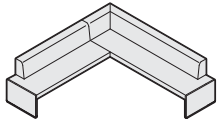

Overall: 96½"D 96½"W 31"H
 Seat: 19"D 18½"H

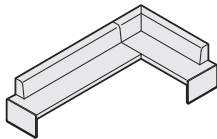

Overall: 69¼"D 123¼"W 31"H
 Seat: 19"D 18½"H

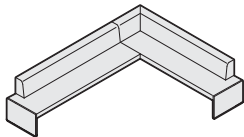

Overall: 96½"D 123¼"W 31"H
 Seat: 19"D 18½"H

▶ Specification Information, continued from previous page

Specification Information

Style Number	U.S. Base Prices														Leather Grades:		
	Fabric Grades:														COL	C	E
	COM	6	7	8	9	10	11	12	13	14							

Right Corner with Back, 8" Offset

COTO9669R8	\$6617	\$6832	\$6916	\$6980	\$7105	\$7211	\$7528	\$7739	\$8200	\$ 8826	\$6833	\$10,741	\$11,437
COM/yds = 9¾, COL/sq ft = 215													

COTO9696R8	\$7137	\$7377	\$7471	\$7542	\$7681	\$7797	\$8147	\$8379	\$8885	\$ 9551	\$7353	\$11,667	\$12,434
COM/yds = 10¾, COL/sq ft = 237													

COTO12369R8	\$7341	\$7596	\$7692	\$7766	\$7913	\$8033	\$8400	\$8643	\$9173	\$ 9856	\$7557	\$12,073	\$12,875
COM/yds = 11¼, COL/sq ft = 248													

COTO12396R8	\$7715	\$7995	\$8101	\$8182	\$8341	\$8472	\$8870	\$9136	\$9713	\$10,435	\$7931	\$12,850	\$13,726
COM/yds = 12½, COL/sq ft = 270													

▶ Specification Information, continued on next page



For Canadian Pricing
 Multiply U.S. Price by the Canadian price factor.
 ▶ See page 1 for details.

Together Bench by Walter Knoll

DESIGN EOOS DESIGN ORIGIN: 2004 GERMANY

► See page 223 for offset diagram.

► Specification Information, continued from previous page

Specification Information

Style Number	U.S. Base Prices													
	Fabric Grades:											Leather Grades:		
	COM	6	7	8	9	10	11	12	13	14	COL	C	E	

Right Corner with Back, 1 1/2" Offset

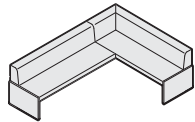

Overall: 69 3/4"D 96 1/2"W 31"H
Seat: 19"D 18 1/2"H

COT09669R15	\$6758	\$6986	\$7075	\$7142	\$7276	\$7386	\$7719	\$7940	\$8423	\$ 9069	\$6974	\$11,085	\$11,816
-------------	--------	--------	--------	--------	--------	--------	--------	--------	--------	---------	--------	----------	----------

COM/yds = 10 1/4, COL/sq ft = 226

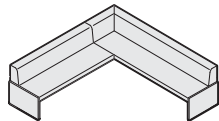

Overall: 96 1/2"D 96 1/2"W 31"H
Seat: 19"D 18 1/2"H

COT09696R15	\$7279	\$7534	\$7630	\$7704	\$7851	\$7971	\$8338	\$8581	\$9111	\$ 9794	\$7495	\$12,011	\$12,813
-------------	--------	--------	--------	--------	--------	--------	--------	--------	--------	---------	--------	----------	----------

COM/yds = 11 1/4, COL/sq ft = 248

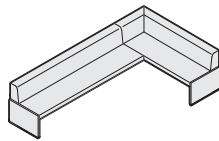

Overall: 69 3/4"D 123 3/4"W 31"H
Seat: 19"D 18 1/2"H

COT012369R15	\$7482	\$7749	\$7851	\$7927	\$8080	\$8207	\$8588	\$8843	\$9397	\$10,099	\$7698	\$12,417	\$13,255
--------------	--------	--------	--------	--------	--------	--------	--------	--------	--------	----------	--------	----------	----------

COM/yds = 11 3/4, COL/sq ft = 259

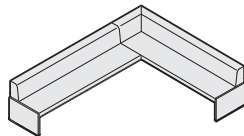

Overall: 96 1/2"D 123 3/4"W 31"H
Seat: 19"D 18 1/2"H

COT012396R15	\$7854	\$8146	\$8257	\$8340	\$8507	\$8644	\$9058	\$9334	\$9935	\$10,676	\$8070	\$13,192	\$14,102
--------------	--------	--------	--------	--------	--------	--------	--------	--------	--------	----------	--------	----------	----------

COM/yds = 12 3/4, COL/sq ft = 281

► Specification Information, continued on next page



For Canadian Pricing
Multiply U.S. Price by the Canadian price factor.
► See page 1 for details.

Together Bench by Walter Knoll *continued*

DESIGN EOOS DESIGN ORIGIN: 2004 GERMANY

Tip: For Customer's Own Material or Leather, see necessary requirements, important processing instructions, and ordering information
 ▶ See *Coalesse Surface Materials Reference Guide*.

Tip: Fabrics and leathers will appear loose with comfort wrinkles when upholstered.

▶ See page 223 for offset diagram.

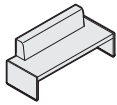

Overall: 26¾" D 69¾" W 31" H
 Seat: 19" D 18½" H

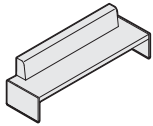

Overall: 26¾" D 96½" W 31" H
 Seat: 19" D 18½" H

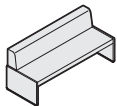

Overall: 26¾" D 69¾" W 31" H
 Seat: 19" D 18½" H

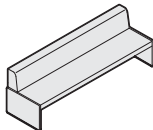

Overall: 26¾" D 96½" W 31" H
 Seat: 19" D 18½" H



For Canadian Pricing
 Multiply U.S. Price by the Canadian price factor.
 ▶ See page 1 for details.

▶ Specification Information, continued from previous page

Specification Information

Style Number	U.S. Base Prices												Leather Grades:		
	Fabric Grades:												COL	C	E
	COM	6	7	8	9	10	11	12	13	14					

Straight with Back, 8" Offset

COTO69WB8	\$3230	\$3315	\$3356	\$3388	\$3450	\$3500	\$3655	\$3758	\$3981	\$4418	\$3446	\$5331	\$5671
COM/yds = 4¾, COL/sq ft = 105													

COTO96WB8	\$3707	\$3831	\$3885	\$3927	\$4009	\$4075	\$4279	\$4414	\$4707	\$5201	\$3923	\$6416	\$6861
COM/yds = 6¼, COL/sq ft = 138													

Straight with Back, 1½" Offset

COTO69WB15	\$3370	\$3463	\$3504	\$3538	\$3602	\$3656	\$3819	\$3927	\$4163	\$4609	\$3586	\$5572	\$5929
COM/yds = 5, COL/sq ft = 110													

COTO96WB15	\$3847	\$3977	\$4033	\$4076	\$4161	\$4231	\$4441	\$4583	\$4889	\$5392	\$4063	\$6656	\$7120
COM/yds = 6½, COL/sq ft = 143													

▶ Specification Information, continued on next page

Together Bench by Walter Knoll

DESIGN EOOS DESIGN ORIGIN: 2004 GERMANY

► Specification Information, continued from previous page

Specification Information

Style Number	U.S. Base Prices											Leather Grades:		
	Fabric Grades:											COL	C	E
	COM	6	7	8	9	10	11	12	13	14				

Straight without Back

COT069	\$2311	\$2377	\$2412	\$2437	\$2489	\$2533	\$2662	\$2749	\$2938	\$3346	\$2527	\$4108	\$4394
--------	--------	--------	--------	--------	--------	--------	--------	--------	--------	--------	--------	--------	--------

COM/yds = 4, COL/sq ft = 88

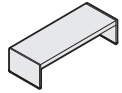

Overall: 26¾"D 69¾"W 18½"H
Seat: 18½"H

COT096	\$2635	\$2720	\$2761	\$2793	\$2855	\$2905	\$3060	\$3163	\$3386	\$3823	\$2851	\$4736	\$5076
--------	--------	--------	--------	--------	--------	--------	--------	--------	--------	--------	--------	--------	--------

COM/yds = 4¾, COL/sq ft = 105

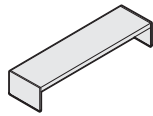

Overall: 26¾"D 96½"W 18½"H
Seat: 18½"H

Lounge Seating



For Canadian Pricing
Multiply U.S. Price by the
Canadian price factor.
► See page 1 for details.

Together Multi-Fabric Diagram

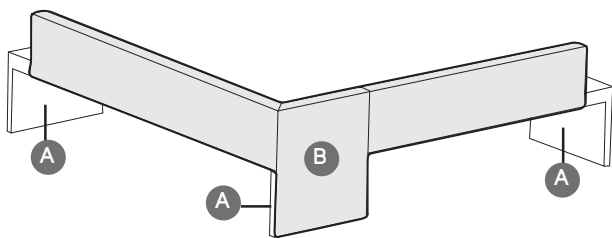
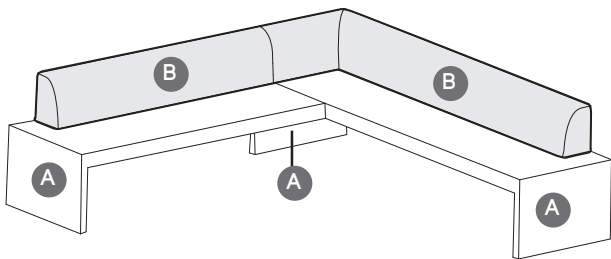
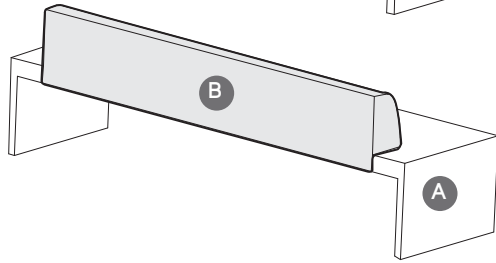
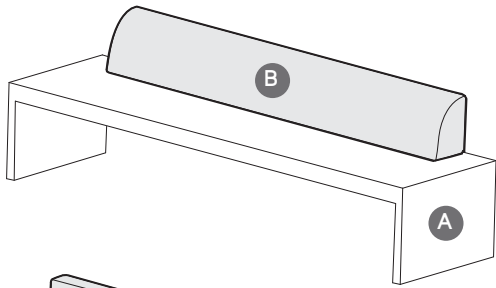

TO: _____

FROM: _____

DATE: _____

FAX....888.413.5161

Together Bench/Straight with Back

- A** Upholstery selections (default for entire unit if B is not selected): _____
- _____
- B** Back: _____

Together Bench/Corner with Back

- A** Upholstery selections (default for entire unit if B is not selected): _____
- _____
- B** Back: _____

*\$113 U.S. list per contrasting fabric specified. List price based on highest fabric grade usage.



For Canadian Pricing
 Multiply U.S. Price by the
 Canadian price factor.
 ▶ See page 1 for details.

Together Offset Diagram

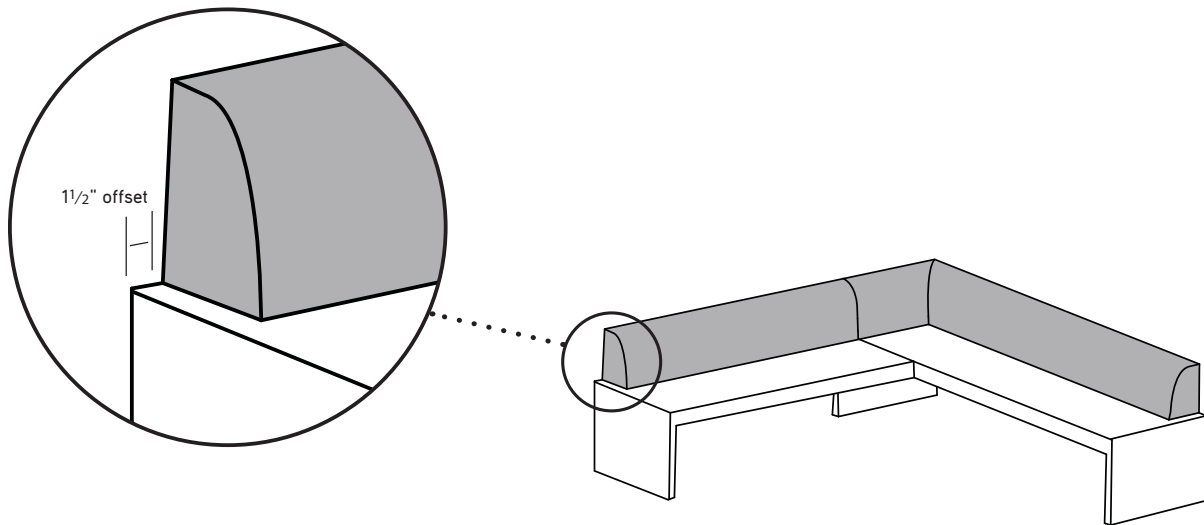
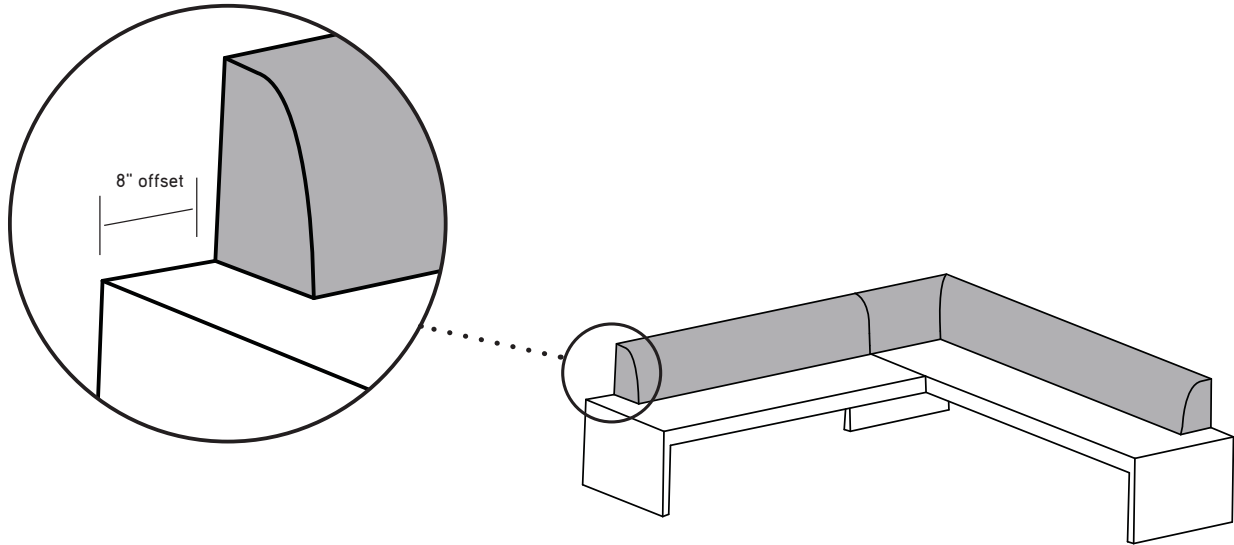

Topo

DESIGN METRO DESIGN GROUP

Topo lounge seating provides an alternative to typical lounge or guest seating for a more relaxed work posture. Topo lounge and lounge Jr. are equipped with glides.

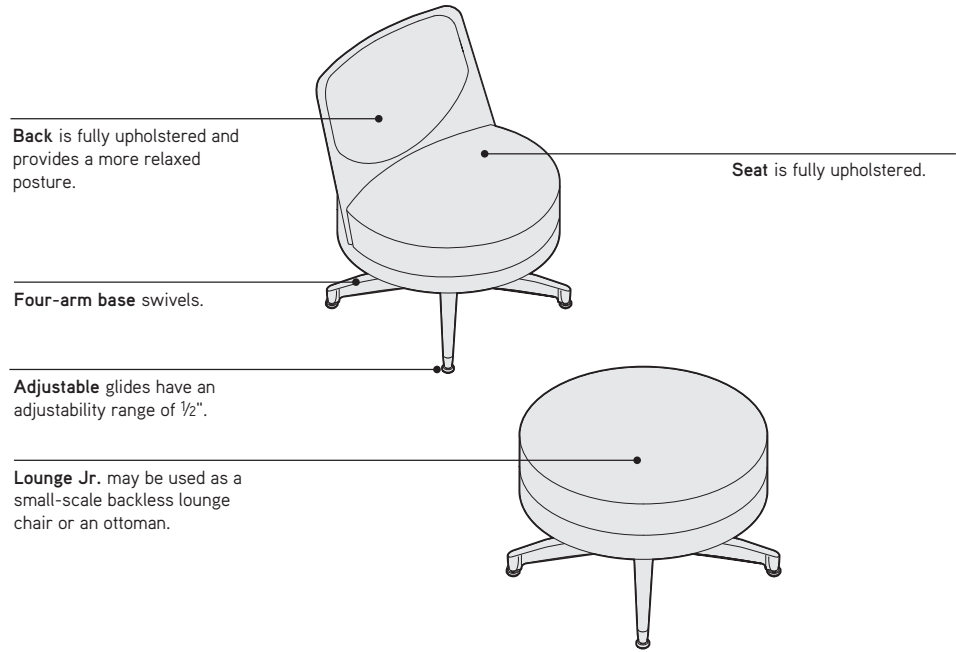

Topo mobile lounge seating features the modern geometric forms to create an alternative to conventional swivel chairs and are appropriately scaled for any lounge application. Topo mobile lounge and mobile lounge Jr. are equipped with casters.

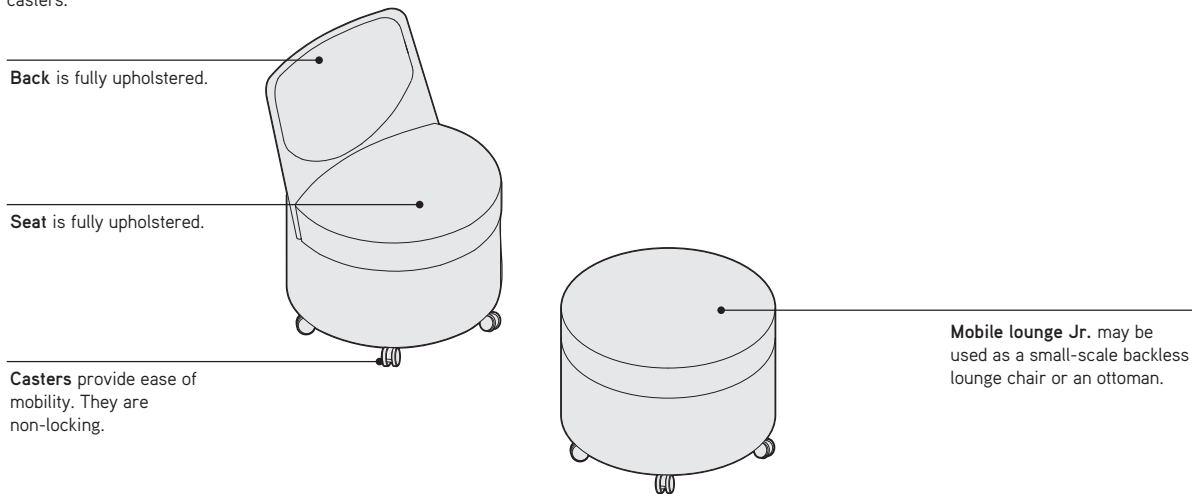

Actual Dimensions

	Overall Diameter	Height	Seat Depth	Width	Seat height from floor	Back height from seat	Footprint
Lounge	24"	31"	18"	24"	17"	15"	26" x 26"
Lounge Jr.	24"	17"	N.A.	N.A.	N.A.	N.A.	26" x 26"
Mobile lounge	24"	31"	18"	24"	17"	15"	26" x 26"
Mobile lounge Jr.	24"	17"	N.A.	N.A.	N.A.	N.A.	26" x 26"

Topo

DESIGN METRO DESIGN GROUP

Product Details

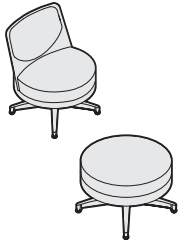

Topo lounge is scaled to fit within workstations and swivels for impromptu meetings.

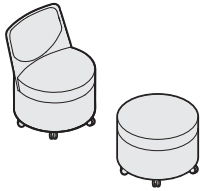

Topo mobile lounge is scaled for 27"H meeting tables or to fit within workstations.

Multiple fabrics can be specified on an individual unit for an additional fee per specified fabric. A lounge or mobile lounge can have up to three additional fabrics. A lounge Jr. or mobile lounge Jr. can have one additional fabric.

Lounge or mobile lounge

- Seat cushion (includes side of seat cushion) - no additional fee
- Base frame - additional fee
- Back cushion (inside back cushion) - additional fee
- Back frame (outside back panel) - additional fee

Lounge Jr. or Mobile lounge Jr.

- Seat cushion (including sides of seat cushion) - no additional fee
 - Base frame - additional fee
- See *Topo multi-fabric diagram and yardage request form*, page 228.

Surface Materials

Lounge:

Seat, back (inside and outside) and base frame

- Fabric

Four-arm base

- Paint

Glides

- Silver only

Mobile lounge:

Seat, back (inside and outside) and base frame

- Fabric

Casters

- Black plastic

Note: Refer to the *Coalesse Surface Materials Reference Guide* for additional surface materials information.

Programs & Services

Fire code seating (FCS) modifications are available to meet CAL TB133 requirements.

► See *Coalesse Surface Materials Reference Guide*.

Customer's Own Material/Leather (COM/COL) Program is available.

► See *Coalesse Surface Materials Reference Guide* for additional information.

Designers

Metro Design Group

Topo Lounge and Lounge Jr.

DESIGN METRO DESIGN GROUP

Tip: For Customer's Own Material or Leather, see necessary requirements, important processing instructions, and ordering information
 ▶ See *Coalesse Surface Materials Reference Guide*.

Tip: When specifying fabric in different price grades, the highest price grade prevails.

Tip: Fabrics and leathers will appear loose with comfort wrinkles when upholstered.

Tip: The COM yards and COL square footage listed on this page reflect the requirements for a single fabric that are based on non-directional 54"W material applied railroaded. For multi-fabric COM requirements, please refer to multi-fabric yardage.
 ▶ Page 229



Standard Includes	Required to Specify
▶ Need help? product details, page 224 • Lounge - seat, inside back, outside back and base frame: fabric or leather • Lounge Jr. - seat and base frame: fabric or leather • Four-arm swivel base: paint • Adjustable glides: silver only	1 Style number 2 Number of fabrics if contrasting fabric style number is selected 3 Fabric or leather color number for seat, inside back, outside back, and base frame, if selected 4 Paint color number for base 5 Options, if selected (see below) ▶ See <i>Coalesse Surface Materials Reference Guide</i> .

Options	U.S. Price	Required to Specify
Surface Materials • Contrasting fabric	+\$113 per fabric	Add suffix K to the style number and select fabric color number.
Contrasting upholstery on lounge Jr.		
• Contrasting fabric on base frame	+\$113	Specify fabric color number for baseframe. ▶ See <i>Topo multi-fabric diagram and yardage request form</i> , page 228.
Fire code seating		
• CAL 133	+\$218	Specify with CAL 133. ▶ See <i>Coalesse Surface Materials Reference Guide</i> .
Acrylic backer		
• Backer for lounge • Backer for lounge jr.	+\$ 27 +\$ 15	Specify with acrylic backer. Specify with acrylic backer. ▶ See <i>Coalesse Surface Materials Reference Guide</i> .

Specification Information														
Style Number	U.S. Base Prices												Leather Grades:	
	Fabric Grades:												COL	C
COM	6	7	8	9	10	11	12	13	14					

Lounge

PLZ431	\$1326	\$1396	\$1433	\$1460	\$1532	\$1570	\$1602	\$1672	\$1704	\$1857	\$1484	\$2424	\$2586
--------	--------	--------	--------	--------	--------	--------	--------	--------	--------	--------	--------	--------	--------

COM/yds = 2½, COL/sq ft = 50

Lounge Jr.

PLJ2417	\$ 976	\$1013	\$1040	\$1058	\$1107	\$1135	\$1157	\$1206	\$1230	\$1337	\$1058	\$1522	\$1587
---------	--------	--------	--------	--------	--------	--------	--------	--------	--------	--------	--------	--------	--------

COM/yds = 1, COL/sq ft = 20



For Canadian Pricing
 Multiply U.S. Price by the Canadian price factor.
 ▶ See page 1 for details.

Topo Mobile Lounge and Mobile Lounge Jr.

DESIGN METRO DESIGN GROUP

Tip: For Customer's Own Material or Leather, see necessary requirements, important processing instructions, and ordering information
 ▶ See *Coalesse Surface Materials Reference Guide*.

Tip: When specifying fabric in different price grades, the highest price grade prevails.

Tip: Fabrics and leathers will appear loose with comfort wrinkles when upholstered.

Tip: The COM yards and COL square footage listed on this page reflect the requirements for a single fabric that are based on non-directional 54"W material applied railroaded. For multi-fabric COM requirements, please refer to multi-fabric yardage.
 ▶ Page 229

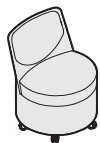

Standard Includes	Required to Specify
<ul style="list-style-type: none"> Need help? product details, page 224 Mobile lounge - seat, inside back, outside back and base frame: fabric or leather Mobile lounge Jr. - seat and base frame: fabric or leather Non-locking casters: black plastic 	<ol style="list-style-type: none"> Style number Number of fabrics if contrasting fabric style number is selected Fabric or leather color number for seat, inside back, outside back, and base frame, if selected Options, if selected (see below) ▶ See <i>Coalesse Surface Materials Reference Guide</i> .

Options	U.S. Price	Required to Specify
Surface Materials <ul style="list-style-type: none"> Contrasting fabric 	+\$113 per fabric	Add suffix K to the style number and select fabric color number.
Contrasting upholstery on lounge Jr. <ul style="list-style-type: none"> Contrasting fabric on base frame 	+\$113	Specify fabric color number for baseframe. ▶ See <i>Topo multi-fabric diagram and yardage request form</i> , page 228.
Fire code seating <ul style="list-style-type: none"> CAL 133 	+\$218	Specify with CAL 133. ▶ See <i>Coalesse Surface Materials Reference Guide</i> .
Acrylic backer <ul style="list-style-type: none"> Backer 	+\$ 29	Specify with acrylic backer. ▶ See <i>Coalesse Surface Materials Reference Guide</i> .

Specification Information														
Style Number	U.S. Base Prices												Leather Grades:	
	Fabric Grades:												COL	C
	COM	6	7	8	9	10	11	12	13	14				

Mobile Lounge

PLM2431	\$1326	\$1419	\$1460	\$1495	\$1580	\$1625	\$1663	\$1748	\$1787	\$1970	\$1566	\$2608	\$2803
COM/yds = 3, COL/sq ft = 60													

Mobile Lounge Jr.

PLMJ2417	\$ 976	\$1046	\$1083	\$1110	\$1182	\$1220	\$1252	\$1322	\$1354	\$1507	\$1178	\$2258	\$2453
COM/yds = 3, COL/sq ft = 60													

 **For Canadian Pricing**
 Multiply U.S. Price by the Canadian price factor.
 ▶ See page 1 for details.

Topo Multi-Fabric and Yardage Request Form

DESIGN METRO DESIGN GROUP

TO: _____

FROM: _____

DATE: _____

FAX...888.413.5161

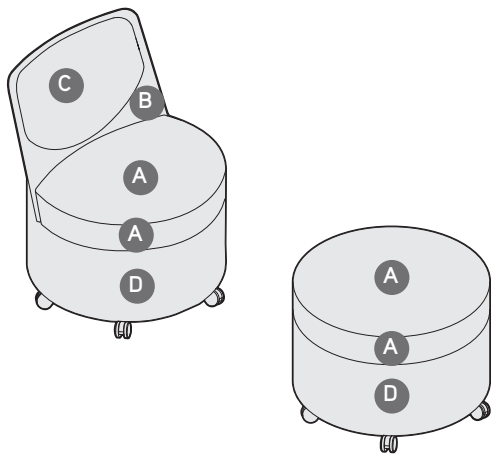

Topo Lounge

A Seat (upholstery selections default for entire unit if B is not selected): _____

B Back: _____

C Back Cushion: _____

D Base Frame: _____

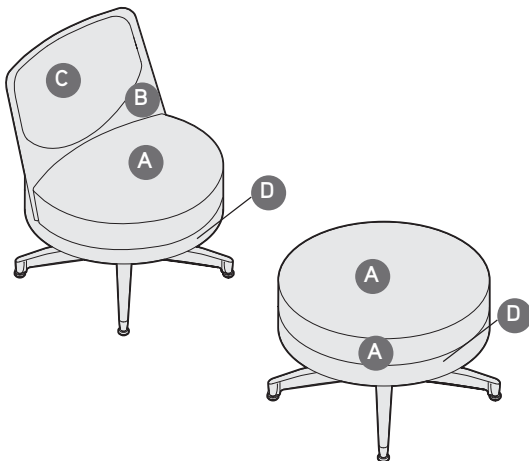

Topo Jr. Lounge

A Seat: _____

B Base Frame: _____

** \$113 U.S. list per contrasting fabric specified. List price based on highest fabric grade usage.*



For Canadian Pricing
 Multiply U.S. Price by the
 Canadian price factor.
 ▶ See page 1 for details.

Multi-Fabric Yardage

CHAIR MODEL	STYLE NUMBER	COM YDS*			
		SEAT CUSHION	INSIDE BACK CUSHION	OUTSIDE BACK PANEL	BASE FRAME
Lounge	PL2431	2¼	1	1	2¼
Lounge Jr.	PLJ2417	2½	N.A.	N.A.	2½
Mobile lounge	PLM2431	2½	1	1	2½
Mobile lounge Jr.	PLMJ2417	2½	N.A.	N.A.	2½

*Fabric yardage is based on non-directional/solid fabrics. Use conversion chart below for repeat/printed fabric yardage.

Non-standard fabric requirements

Yardage requirements shown are based on non-directional 54"W material applied railroaded. Coalesse will apply fabric railroaded unless instructed otherwise on the dealer's purchase order. The following conversion chart should be used to determine yardage requirements when COM has a repeat of 2" or more. Please contact Coalesse customer service for a yardage quotation if the fabric is less than 54" wide, has a repeat of more than 24", or if the fabric must be cut-right.

CONVERSION CHART

PRODUCT	REPEAT		
	2" - 8"	9" - 14"	15" - 24"
All other products	15%	25%	35%

Yardage quotations will also be provided for order of 10 or more pieces.

Cutting direction guidelines

Cutting direction is based on the fabric width and the way the fabric is cut from the roll and applied to Coalesse products. There are two cutting directions: railroaded or cut-right.

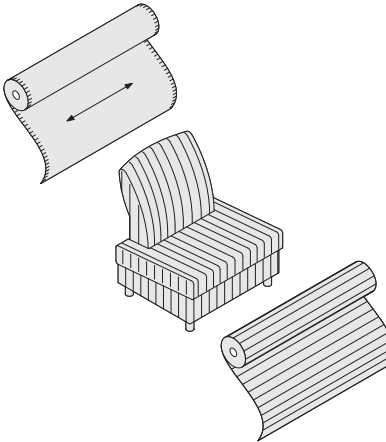

Horizontal or railroaded (across roll, warp horizontal) means fabric is cut across the roll; selvages are on the top and bottom.

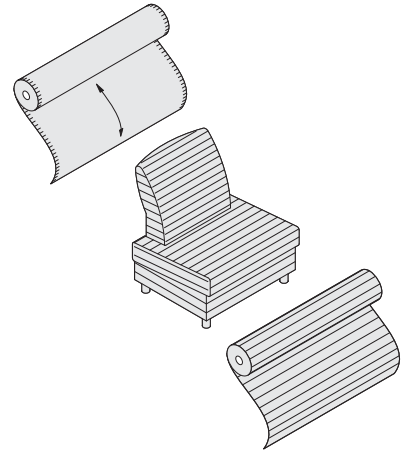

Vertical or cut-right (down roll, warp vertical) means fabric is cut in the same direction it is woven; selvages are on the left and right sides.

Coalesse reserves the right to railroad or apply fabric according to weave unless instructions specify otherwise. Fabrics are railroaded when possible to avoid seams in large upholstered areas and/or single cushion units. If a fabric is questionable, a cutting of adequate size showing full repeat (if any) should be sent to Coalesse for a fabric requirement quotation.

Visalia Lounge

DESIGN COALESSE DESIGN STUDIO

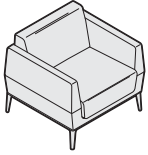

Tip: Fabrics and leathers will appear loose with comfort wrinkles when upholstered.

Tip: All cushions are attached.

Tip: Recommended leathers are Elmosoft Grade C and Elmorustical Grade E.

Tip: Special color match, consult Customer Service.

Tip: For Customer's Own Material or Leather, see necessary requirements, important processing instructions, and ordering information
 ▶ See *Coalesse Surface Materials Reference Guide*.

Standard Includes	Required to Specify
<ul style="list-style-type: none"> • Frame: unibody construction with finger jointed plywood • Cast aluminum legs • Upholstery: multiple densities of polyurethane foams and polyester fiber on seat and back • Upper and lower upholstery accents with double needle top stitch, if selected • Leg: powder coat paint 	<ol style="list-style-type: none"> 1 Style number 2 Fabric or leather color number for seat, back, and arms 3 Upholstery accent color number, if selected 4 Paint color number for legs: <ul style="list-style-type: none"> 4138 Graphite Gloss Black Matte 4141 Platinum Matte 4144 Black Gloss 4145 Milk Gloss 4148 Midnight Brown Gloss 4180 Graphite Matte 4193 Midnight Brown Matte 4242 Milk Matte 4710 Black Matte 5 Options, if selected (see below) ▶ See <i>Coalesse Surface Materials Reference Guide</i> .

Required Selections	U.S. Price	Required to Specify
Upholstery accent	Prices to right	Select accent upholstery.

Options	U.S. Price	Required to Specify
Surface Materials Fire Code Seating <ul style="list-style-type: none"> • CAL 133 for lounge chairs and ottomans +\$218 • CAL 133 for two-seat chairs and two-seat benches +\$437 • CAL 133 for three-seat chairs +\$568 		Specify with <i>CAL 133</i> . Specify with <i>CAL 133</i> . Specify with <i>CAL 133</i> . ▶ See <i>Coalesse Surface Materials Reference Guide</i> .

Acrylic backer <ul style="list-style-type: none"> • Backer for lounge chairs with single fabric +\$33 • Backer for lounge chairs with two fabrics +\$39 • Backer for two-seat chairs with single fabric +\$44 • Backer for two-seat chairs with two fabrics +\$50 • Backer for three-seat chairs with single fabric +\$52 • Backer for three-seat chairs with two fabrics +\$62 • Backer for ottomans chairs with single fabric +\$17 • Backer for ottomans chairs with two fabrics +\$17 • Backer for two-seat benches chairs with single fabric +\$21 • Backer for two-seat benches chairs with two fabrics +\$21 		Specify with acrylic backer. Specify with <i>acrylic backer</i> . Specify with <i>acrylic backer</i> . Specify with <i>acrylic backer</i> . Specify with <i>acrylic backer</i> . Specify with <i>acrylic backer</i> . Specify with <i>acrylic backer</i> . Specify with <i>acrylic backer</i> . Specify with <i>acrylic backer</i> . ▶ See <i>Coalesse Surface Materials Reference Guide</i> .
--	--	---

Metal Legs <ul style="list-style-type: none"> • Paint 	No cost	Specify paint color number.
---	---------	-----------------------------



For Canadian Pricing
 Multiply U.S. Price by the Canadian price factor.
 ▶ See page 1 for details.

Visalia Lounge

DESIGN COALESSE DESIGN STUDIO

Specification Information

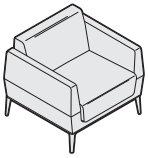
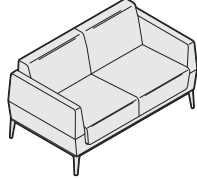
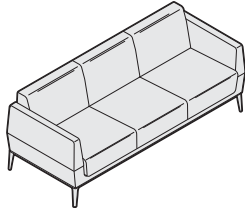
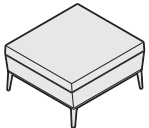
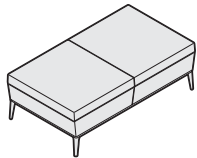
Lounge	Two-Seat	Three-Seat	Ottoman	Bench										
														
Overall: 29"D 31¾"W 28"H Seat height: 17"H Arm height to the floor: 23"H Inside: 19"D 23"W 17"H	Overall: 29"D 53¾"W 28"H Seat height: 17"H Arm height to the floor: 23"H Inside: 19"D 45"W 17"H	Overall: 29"D 73¾"W 28"H Seat height: 17"H Arm height to the floor: 23"H Inside: 19"D 65"W 17"H	Overall: 29"D 30"W 16¼"H	Overall: 29"D 52"W 16¼"H										
Style Number	Upholstery	U.S. Base Prices										Leather Grades:		
		Fabric Grades:										COL	C	E
		COM	6	7	8	9	10	11	12	13	14			

Lounge Chair with Single Fabric

COJHL100	\$1807	\$1848	\$1890	\$1927	\$2011	\$2075	\$2118	\$2146	\$2286	\$2477	\$2023	\$2978	\$3106
COM/yds = 3¾, COL/sq ft = 83													

Lounge Chair with Accent Upholstery

COJHLC100	Standard Upholstery	\$1897	\$1897	\$1985	\$2023	\$2111	\$2176	\$2220	\$2252	\$2396	\$2593	\$2052	\$2968	\$3085
COM/yds = 3, COL/sq ft = 66														
	Accent Upholstery	No cost	No cost	+\$ 5	+\$ 17	+\$ 47	+\$ 68	+\$ 82	+\$ 94	+\$ 141	+\$ 207	+\$ 216	+\$ 331	+\$ 371
COM/yds = 1, COL/sq ft = 22														

Two-Seat Sofa with Single Fabric

COJHL200	\$2795	\$2865	\$2925	\$2976	\$3092	\$3180	\$3238	\$3280	\$3473	\$3736	\$3011	\$4420	\$4595
COM/yds = 5, COL/sq ft = 110													

Two-Seat Sofa with Accent Upholstery

COJHLC200	Standard Upholstery	\$2885	\$2955	\$3014	\$3065	\$3181	\$3269	\$3327	\$3368	\$3561	\$3823	\$3101	\$4498	\$4672
COM/yds = 4½, COL/sq ft = 99														
	Accent Upholstery	No cost	No cost	+\$ 10	+\$ 23	+\$ 56	+\$ 80	+\$ 98	+\$ 109	+\$ 164	+\$ 236	+\$ 216	+\$ 427	+\$ 477
COM/yds = 1¼, COL/sq ft = 27														

Three-Seat Sofa with Single Fabric

COJHL300	\$3211	\$3312	\$3388	\$3452	\$3600	\$3714	\$3789	\$3841	\$4089	\$4424	\$3427	\$5306	\$5531
COM/yds = 6, COL/sq ft = 132													

Three-Seat Sofa with Accent Upholstery

COJHLC300	Standard Upholstery	\$3301	\$3397	\$3469	\$3531	\$3673	\$3782	\$3853	\$3904	\$4140	\$4462	\$3517	\$5305	\$5521
COM/yds = 5½, COL/sq ft = 121														
	Accent Upholstery	No cost	No cost	+\$ 27	+\$ 47	+\$ 91	+\$ 125	+\$ 149	+\$ 164	+\$ 238	+\$ 340	+\$ 216	+\$ 607	+\$ 675
COM/yds = 1¾, COL/sq ft = 39														

► Specification Information, continued on next page

For Canadian Pricing
 Multiply U.S. Price by the
 Canadian price factor.
 ► See page 1 for details.

Visalia Lounge *continued*

DESIGN COALESSE DESIGN STUDIO

► Specification Information, continued from previous page

Specification Information

Lounge

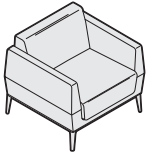

Overall: 29"D 31¾"W 28"H
 Seat height: 17"H
 Arm height to the floor: 23"H
 Inside: 19"D 23"W 17"H

Two-Seat

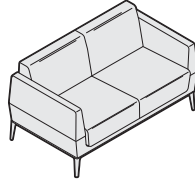

Overall: 29"D 53¾"W 28"H
 Seat height: 17"H
 Arm height to the floor: 23"H
 Inside: 19"D 45"W 17"H

Three-Seat

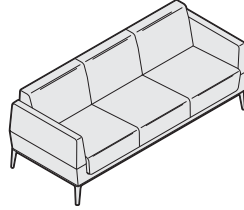

Overall: 29"D 73¾"W 28"H
 Seat height: 17"H
 Arm height to the floor: 23"H
 Inside: 19"D 65"W 17"H

Ottoman

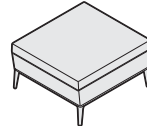

Overall: 29"D 30"W 16¼"H

Bench

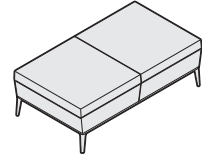

Overall: 29"D 52"W 16¼"H

Style
Number

Upholstery

U.S. Base Prices

Fabric Grades:
COM 6 7 8 9 10 11 12 13 14

Leather Grades:
COL C E

Ottoman with Single Fabric

COJHB100	\$ 974	\$ 984	\$1010	\$1034	\$1085	\$1125	\$1150	\$1168	\$1254	\$1371	\$1190	\$1674	\$1753
COM/yds = 2, COL/sq ft = 44													

Ottoman with Accent Upholstery

COJHBC100	Standard Upholstery	\$1064	\$1064	\$1065	\$1075	\$1100	\$1121	\$1133	\$1142	\$1185	\$1243	\$1280	\$1395	\$1435
COM/yds = 1, COL/sq ft = 22														
	Accent Upholstery	No cost	No cost	+\$ 1	+\$ 11	+\$ 36	+\$ 57	+\$ 69	+\$ 78	+\$ 121	+\$ 179	+\$ 216	+\$ 331	+\$ 371
COM/yds = 1, COL/sq ft = 22														

Two-Seat Bench with Single Fabric

COJHB200	\$1391	\$1413	\$1447	\$1474	\$1540	\$1589	\$1620	\$1644	\$1751	\$1897	\$1607	\$2378	\$2486
COM/yds = 3, COL/sq ft = 50													

Two-Seat Bench with Accent Upholstery

COJHBC200	Standard Upholstery	\$1481	\$1481	\$1507	\$1528	\$1572	\$1606	\$1629	\$1644	\$1718	\$1819	\$1697	\$2089	\$2157
COM/yds = 1¾, COL/sq ft = 39														
	Accent Upholstery	No cost	No cost	+\$ 1	+\$ 12	+\$ 37	+\$ 58	+\$ 71	+\$ 80	+\$ 124	+\$ 183	+\$ 216	+\$ 340	+\$ 381
COM/yds = 1, COL/sq ft = 22														



For Canadian Pricing
 Multiply U.S. Price by the
 Canadian price factor.
 ► See page 1 for details.

Visalia Multi-Fabric Diagram

Applies to Visalia models including: Lounge, two-seat sofa, three-seat sofa, ottoman, and two-seat bench.

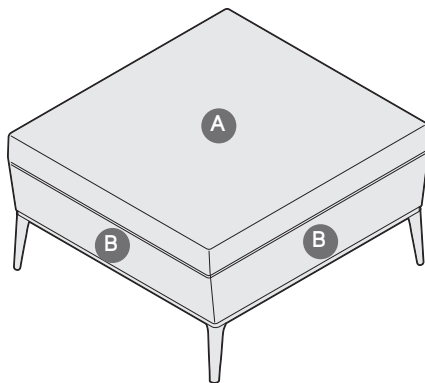
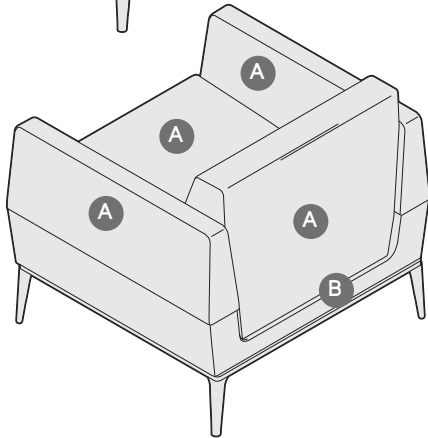
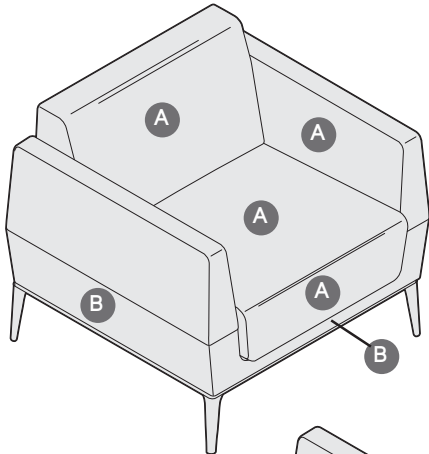

TO: _____

FROM: _____

DATE: _____

FAX...888.413.5161

A Upholstery Selection (default for entire unit if B is not selected): _____

B Accent: _____

Specify model below:

COJHLC100 Lounge

COJHLC200 Two-Seat Sofa

COJHLC300 Three-Seat Sofa

COJHBC100 Ottoman

COJHBC200 Two-Seat Bench

Guest/Side/Stack Seating

Andoo	236
Bindu	238
Bob	239
Capa	240
CH24 Wishbone	241
CH20 Elbow Chair	242
CH53 Stool	243
Enea Stacker with Arms	244
Enea Stacker without Arms	246
Enea Bar-Height Stools with Arms	248
Enea Bar-Height Stools without Arms	250
Enea Café Stool with Back	252
Enea Café Stools	254
Enea Lottus Armless Chairs	256
Enea Lottus Cantilever Arm Chairs	258
Enea Lottus Aluminum Loop Arm Chairs	260
Enea Lottus Sled Base Stools	262
Enea Lottus Post Base Stools	264
Kart	266
Kathryn	276
Last Minute	278
Lox Chairs	279
Lox Stools	280
Rocky	281
SW_1	285
Switch Guest	286
Switch Stools without Arms	288
Wrapp	289
X-Stack	290

Andoo Chairs **X4/14** by Walter Knoll

DESIGN EOOS DESIGN ORIGIN: 2006 GERMANY

Tip: For Customer's Own Material or Leather, see necessary requirements, important processing instructions, and ordering information
 ▶ See Coalesse Surface Materials Reference Guide.

Tip: Fabrics and leathers will appear loose with comfort wrinkles when upholstered.

Tip: Saddle stitch in nine colors for leather.

Tip: Frame in white oak may have natural variable flecking. If the flecking is not desired, select walnut species.

Standard Includes

- Upholstery for chair: fabric or leather
- Frame: White oak

Required to Specify

- 1 Style number
 - 2 Fabric or leather color number for upholstery
 - 3 Options, if selected (see below)
- ▶ See Coalesse Surface Materials Reference Guide.

Options

Options	U.S. Price	Required to Specify
Surface Materials		
Fire code seating		
• CAL 133	+\$218	Specify with CAL 133. ▶ See Coalesse Surface Materials Reference Guide.
Acrylic backer		
• Backer for chair without arms	+\$ 10	Specify with acrylic backer.
• Backer for chair with closed arms	+\$ 12	Specify with acrylic backer. ▶ See Coalesse Surface Materials Reference Guide.
Frame		
• Walnut on chair without arms	+\$101	Select walnut color number.
• Walnut on chair with arms	+\$134	Select walnut color number.

Specification Information

Style Number	U.S. Base Prices														Leather Grades:		
	Fabric Grades:														COL	C	E
	COM	6	7	8	9	10	11	12	13	14							

Chair without Arms

COANDO **X4/14** \$1499 \$1494 \$1505 \$1513 \$1529 \$1543 \$1583 \$1611 \$1669 \$1748 \$1715 \$2184 \$2273

COM/yds = 1¼, COL/sq ft = 27



Overall: 21¾"D 18½"W 32"H
 Seat: 17"D 17"W 18½"H

Chair with Closed Arms

COANDCLSD **X4/14** \$1931 \$1932 \$1945 \$1954 \$1975 \$1991 \$2039 \$2072 \$2142 \$2207 \$2147 \$2716 \$2823

COM/yds = 1½, COL/sq ft = 33

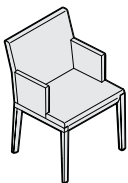

Overall: 22½"D 20¾"W 32"H
 Seat: 17"D 17"W 18½"H

 **For Canadian Pricing**
 Multiply U.S. Price by the Canadian price factor.
 ▶ See page 1 for details.

X4/14 = Last order entry
 April 20, 2014

Andoo Tables **X4/14** by Walter Knoll

DESIGN EOOS DESIGN ORIGIN: 2006 GERMANY

Tip: Frame in white oak may have natural variable flecking. If the flecking is not desired, select walnut species.

Standard Includes	Required to Specify
-------------------	---------------------

- Table: wood

- 1 Style number
 - 2 Wood color number for table
- See *Coalesse Surface Materials Reference Guide*.

Specification Information

Dimensions			Style Number	U.S. Prices	
D	W	H		White Oak	Walnut

Dining Table with Short Fixed Top

37½"	67"	29¼"	COANDOTBL67 X4/14	\$6357	\$6763
------	-----	------	--------------------------	--------	--------

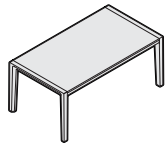

Dining Table with Long Fixed Top

37½"	78¾"	29¼"	COANDOTBL78 X4/14	\$6795	\$7250
------	------	------	--------------------------	--------	--------

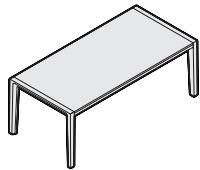

Guest/ Side/ Stack Seating

 **For Canadian Pricing**
 Multiply U.S. Price by the Canadian price factor.
 ► See page 1 for details.

X4/14 = Last order entry
 April 20, 2014

Bindu

DESIGN BRIAN KANE DESIGN ORIGIN: 2009 UNITED STATES

Tip: Fabrics and leathers will appear loose with comfort wrinkles when upholstered.

Tip: Craft in upholstery cautions the use of stripes and patterns on Bindu. Please use fabric database when specifying.

Tip: For Customer's Own Material or Leather, see necessary requirements, important processing instructions, and ordering information
 ▶ See *Coalesse Surface Materials Reference Guide*.

Tip: For fabric with large pattern and specific pattern location is desired, contact Customer Service.

Standard Includes		Required to Specify	
	<ul style="list-style-type: none"> Bent plywood frame Chair: fabric Molded polypropylene foam Frame: 4144 Black Gloss Glides: non-marring polymer 		1 Style number 2 Fabric or leather color number for upholstery 3 Options, if selected (see below) ▶ See <i>Coalesse Surface Materials Reference Guide</i> .
Options		U.S. Price	Required to Specify
Surface Materials	Acrylic backer		
	<ul style="list-style-type: none"> Backer 	+\$ 27	Specify with <i>acrylic backer</i> . ▶ See <i>Coalesse Surface Materials Reference Guide</i> .
	Fire code seating		
	<ul style="list-style-type: none"> CAL 133 	+\$245	Specify with CAL 133 ▶ See <i>Coalesse Surface Materials Reference Guide</i> .
Base	<ul style="list-style-type: none"> Polished trivalent chrome (available on CO200G & CO300G) 	+\$136	Specify with <i>trivalent chrome</i> .

Specification Information													
Style Number	U.S. Base Prices												
	Fabric Grades:											Leather Grades:	
	COM	6	7	8	9	10	11	12	13	14	COL	C	E

Low Back Guest/Side Chair

CO200G	\$1065	\$1106	\$1131	\$1150	\$1189	\$1222	\$1320	\$1384	\$1455	\$1710	\$1281	\$2458	\$2672
--------	--------	--------	--------	--------	--------	--------	--------	--------	--------	--------	--------	--------	--------

COM/yds = 3, COL/sq ft = 66



Overall: 25"D 25"W 33¾"H
 Inside: 18¾"D 18½"-19½"W 15"H
 Seat: 17¾"H
 Arm: 26¼"H

Mid Back Guest/Side Chair

CO300G	\$1230	\$1271	\$1296	\$1315	\$1354	\$1387	\$1485	\$1549	\$1620	\$1875	\$1446	\$2623	\$2837
--------	--------	--------	--------	--------	--------	--------	--------	--------	--------	--------	--------	--------	--------

COM/yds = 3, COL/sq ft = 66



Overall: 25"D 25"W 37¾"H
 Inside: 18¾"D 18½"-19½"W 21"H
 Seat: 17¾"H
 Arm: 26¼"H



For Canadian Pricing
 Multiply U.S. Price by the Canadian price factor.
 ▶ See page 1 for details.

Bob Chair by Walter Knoll

DESIGN PEARSON LLOYD DESIGN ORIGIN: 2007 GERMANY

Tip: For Customer's Own Material or Leather, see necessary requirements, important processing instructions, and ordering information
 ▶ See *Coalesse Surface Materials Reference Guide*.

Tip: Fabrics and leathers will appear loose with comfort wrinkles when upholstered.

Standard Includes

- Base: 8040 aluminum matte polished
- Upholstery for chair: fabric or leather
- Glides

Required to Specify

- 1 Style number
 - 2 Number of fabrics if contrasting fabric style number is selected
 - 3 Fabric or leather color number for upholstery
 - 4 Options, if selected (see below)
- ▶ See *Coalesse Surface Materials Reference Guide*.

Options

Options	U.S. Price	Required to Specify
Surface Materials		
• Contrasting fabric	+\$113 per fabric	Add suffix K to the style number and select fabric color number.
Fire code seating		
• CAL 133	+\$218	Specify with CAL 133. ▶ See <i>Coalesse Surface Materials Reference Guide</i> .
Acrylic backer		
• Backer for guest chair	+\$ 21	Specify with acrylic backer.
• Backer for ottoman	+\$ 10	Specify with acrylic backer. ▶ See <i>Coalesse Surface Materials Reference Guide</i> .
Glides		
• Felted glides	+\$ 16	Specify with felted glides.

Specification Information

Style Number	U.S. Base Prices										Leather Grades:		
	Fabric Grades:										COL	C	E
	COM	6	7	8	9	10	11	12	13	14			

Guest Swivel Chair

231	\$2211	\$2229	\$2246	\$2264	\$2285	\$2309	\$2377	\$2421	\$2503	\$2653	\$2436	\$3243	\$3389
-----	--------	--------	--------	--------	--------	--------	--------	--------	--------	--------	--------	--------	--------

COM/yds = 2, COL/sq ft = 44



Overall: 25¼"D 27¼"W 29¾"H
 Inside: 18"D 18"W 12½"H
 Seat: 18½"H
 Arm: 26½"H



Overall: 18½"D 19¾"W 15¼"H

Ottoman

221-H	\$1003	\$ 994	\$1004	\$1010	\$1021	\$1031	\$1066	\$1088	\$1130	\$1190	\$1228	\$1612	\$1685
-------	--------	--------	--------	--------	--------	--------	--------	--------	--------	--------	--------	--------	--------

COM/yds = 1, COL/sq ft = 22



For Canadian Pricing
 Multiply U.S. Price by the Canadian price factor.
 ▶ See page 1 for details.

Capa Chair

DESIGN EOOS DESIGN ORIGIN: GERMANY



Overall: 24¾"D 23¾"W 31½"H
Inside: 18"D 16½"W 15"H
Seat: 18"H
Arm: 28"H

Tip: Fabrics and leathers will appear loose with comfort wrinkles when upholstered.

Tip: Frame design allows back to flex to match occupant's back shape.

Tip: Due to the design and construction techniques of the Capa Chair only certain textiles can be successfully applied, therefore all COM fabrics must be submitted to Coalesse for approval prior to order acceptance.

Tip: Recommended leathers are Elmosoft Grade C and Elmorustical Grade E.

Tip: Special color match, consult customer service.

Tip: For Customer's Own Material or Leather, see necessary requirements, important processing instructions, and ordering information
 ► See Coalesse Surface Materials Reference Guide.

Tip: Chair stacks five high.

Standard Includes	Required to Specify
<ul style="list-style-type: none"> • Frame: hardwood plywood, steel tubing and bar stock • Arms: solid steel rod and bar stock • Upholstery: arms, back, and seat foam are molded around the frame components • Legs: trivalent matte chrome (M) or polished chrome (PC) leg finish 	1 Style number 2 Number of fabrics if contrasting fabric style number is selected 3 Fabric or leather color number for upholstery 4 Options, if selected (see below) ► See Coalesse Surface Materials Reference Guide.

Options	U.S. Price	Required to Specify
Surface Materials <ul style="list-style-type: none"> • Contrasting fabric 	+\$113 per fabric	Add suffix K to the style number and select fabric color number.
Fire code seating <ul style="list-style-type: none"> • CAL 133 	+\$113	Specify with CAL 133.
Acrylic backer <ul style="list-style-type: none"> • Backer 	+\$ 17	Specify with acrylic backer. ► See Coalesse Surface Materials Reference Guide.

Specification Information														
Style Number	U.S. Base Prices												Leather Grades:	
	Fabric Grades:												COL	C
	COM	6	7	8	9	10	11	12	13	14				

Chair

1810M	\$960	\$ 993	\$1011	\$1029	\$1059	\$1087	\$1141	\$1194	\$1252	\$1374	\$1232	\$2211	\$2387
1810PC	\$984	\$1025	\$1040	\$1053	\$1088	\$1117	\$1165	\$1218	\$1276	\$1401	\$1256	\$2240	\$2411

COM/yds = 2, COL/sq ft = 44

Stacking Dolly

9014S	\$699	N.A.	N.A.	N.A.	N.A.	N.A.	N.A.	N.A.	N.A.	N.A.	N.A.	N.A.	N.A.
-------	-------	------	------	------	------	------	------	------	------	------	------	------	------



For Canadian Pricing
 Multiply U.S. Price by the Canadian price factor.
 ► See page 1 for details.

CH24 Wishbone Chair by Carl Hansen & Son

DESIGN HANS WEGNER DESIGN ORIGIN: DENMARK, 1949

 = Available in Rapid10.



Overall: 20"D 21½"W 29½"H
Seat: 17½"25"H

Tip: Not all finishes offered on every wood species, see matrix below.

Standard Includes

- Frame: wood
- Hand-woven papercord seat





Required to Specify

- 1 Style number
- 2 Papercord: (See prices below)
 - Black: P500
 - Natural: P501
 - White: P502
- 3 Wood species/finish number, (See matrix below)
- 4 Options, if selected (see below)

Options

Options	U.S. Price	Required to Specify
Leather Cushion	• Black leather cushion +\$209	Specify with black leather cushion.

Specification Information

Style Number	U.S. Base Prices		
	Papercord:		
	Natural	Black	White
 CH24BLKOAK	\$1331	\$1492	N.A.
 CH24OAK	\$1599	\$1760	N.A.
 CH24ASH	\$1503	\$1664	N.A.
CH24WALNUT	\$2275	\$2436	N.A.
CH24CHERRY	\$1833	\$1994	N.A.
 CH24BEECH	\$1390	\$1551	\$1551

Wood Species/Finish Number Matrix

Finish	Wood Species Number:					
	Black Oak	Oak	Ash	Walnut	Cherry	Beech
Lacquer	3245	3255	3615	3325	3407	N.A.
White Oil	N.A.	3265	3645	N.A.	N.A.	N.A.
Oil	N.A.	N.A.	N.A.	3335	3417	N.A.
CHS Color	N.A.	N.A.	N.A.	N.A.	N.A.	3208, 3209, 3210, 3211, 3213, 3216, 3218, 3219, 3220, 3221, 3223, 3228, 3229, 3236, 3237, 3238, 3239, 3245, 3247, 3248, 3251, 3253, 3256, 3267, and 3268

Tip: CHS standard colors are not available when white papercord is selected.

Guest/ Side/ Stack Seating

 **For Canadian Pricing**
Multiply U.S. Price by the Canadian price factor.
▶ See page 1 for details.

Coalesse

CH20 Elbow Chair by Carl Hansen & Son

DESIGN HANS WEGNER DESIGN ORIGIN: DENMARK, 1956



Overall: 18 1/2"D 21 1/4"W 28"H
Seat: 18"H

Tip: For Customer's Own Material or Leather, see necessary requirements, important processing instructions, and ordering information
▶ See *Coalesse Surface Materials Reference Guide*.

Standard Includes

- Upholstered seat cushion: fabric or leather
- Bent ply frame

Required to Specify

- 1 Style number
- 2 Fabric color number for upholstery, if selected
- 3 If Loke Leather is selected specify leather color number:
 - 5072 Loke 7210 Sand
 - 5073 Loke 7050 Light Antique
 - 5074 Loke 7270 Brown
 - 5075 Loke 7170 Red
 - 5076 Loke 7150 Black
 - 5077 Loke 7160 White
- 4 Wood species/finish number, (See matrix below)

Specification Information

Style Number	U.S. Prices			Leather: Loke Leather
	Fabric: COM	Group 2	Group 3	
CH20OAK	\$1857	\$1890	\$1906	\$2025
CH20BEECH	\$1648	\$1681	\$1697	\$1816

COM/yds = 1 yd

Wood Species/Finish Number Matrix

Finish	Wood Species Number:		
	Oak	Ash	Beech
Lacquer	3255	3615	N.A.
White Oil	3265	3645	N.A.
CHS color	N.A.	N.A.	3246



For Canadian Pricing
Multiply U.S. Price by the Canadian price factor.
▶ See page 1 for details.

Coalesse

CH53 Stool

DESIGN HANS WEGNER DESIGN ORIGIN: DENMARK, 1966



Overall: 15¼"D 19¾"W 17"H

Tip: Not all finishes offered on every wood species, see matrix below.

Standard Includes

- Frame: wood
- Hand-woven papercord seat

Required to Specify

- 1 Style number
- 2 Papercord: (See prices below)
 - Black: P500
 - Natural: P501
- 3 Wood species/finish number, (See matrix below)

Specification Information

Style Number	U.S. Prices	
	Papercord:	
	Natural	Black
CH53OAK	\$890	\$1051

Wood Species/Finish Number Matrix

Finish	Wood Species Number:
	Oak
Lacquer	3255
White Oil	3265

Guest/Side/Stack Seating

Enea Stacker With Arms

DESIGN JACOB LLUSCA DESIGN ORIGIN: SPAIN

 = Available in Rapid10.

Tip: Due to the design and construction techniques of the Enea Chair only certain textiles can be successfully applied, therefore all COM fabrics must be submitted to Coalesse for approval prior to order acceptance.

Tip: Fabrics and leathers will appear loose with comfort wrinkles when upholstered.

Tip: For Customer's Own Material or Leather, see necessary requirements, important processing instructions, and ordering information
 ▶ See *Coalesse Surface Materials Reference Guide*.

Tip: Contrasting fabric option available on model 3501 only.

Tip: CAL 133 for polypropylene is available as a special quote. Polypropylene color will change slightly when FR treatment is applied. Contact Customer Service for availability and pricing. Minimum quantity will apply.

Tip: Need sketch for ganging.

Tip: Models 3501 and 3500 in black belt leather or wood are approved for CAL 133 at no charge.

Tip: Tablet is 11"D x 9"W.

Tip: Belt leather upcharge applies to COM pricing.

Tip: Arm chairs stack nine high. Arm chair with tablet stacks six high, chairs cannot be stacked with storage rack.



Overall: 22½"D 22½"W 33¼"H
 Inside: 18"D 18"W 15¼"H
 Seat: 18"H
 Arm: 26¼"H



For Canadian Pricing
 Multiply U.S. Price by the Canadian price factor.
 ▶ See page 1 for details.

Standard Includes		Required to Specify	
	<ul style="list-style-type: none"> • Frame: constructed of steel tubing • Seat and back: molded nylon, wood, or upholstery (wood is laminated layers of hard maple veneer) 		<ol style="list-style-type: none"> 1 Style number 2 Fabric or leather color number for upholstery, if selected 3 Plastic or wood finish color number for seat and back, if selected 4 Base/frame finish: black gloss, white gloss, and silver metallic 5 Options, if selected (see below) ▶ See <i>Coalesse Surface Materials Reference Guide</i> .
Options		U.S. Price	Required to Specify
Surface Materials	<ul style="list-style-type: none"> • Contrasting fabric 	+\$113 per fabric	Add suffix K to the style number and select fabric color number.
	Fire code seating <ul style="list-style-type: none"> • CAL 133 	+\$113	Specify with CAL 133. ▶ See <i>Coalesse Surface Materials Reference Guide</i> .
	Acrylic backer <ul style="list-style-type: none"> • Backer for chair with upholstered seat and back • Backer for chair with upholstered seat and wood back 	+\$ 17 +\$ 8	Specify with <i>acrylic backer</i> . ▶ See <i>Coalesse Surface Materials Reference Guide</i> .
Ganging	• Ganging	+\$ 60	Specify with <i>ganging</i> .
Storage Rack	• Storage rack	+\$253	Specify with <i>storage rack</i> .
Tablet	• Black powder coat	+\$313	Specify with <i>tablet</i> and specify side as facing.
Belt Leather	<ul style="list-style-type: none"> • Black belt leather available on model 3501 • White leather available on model 3501 	-\$ 10 +\$ 30	Specify with <i>black belt leather</i> . Specify with <i>white leather</i> .
Felt Glides	• Glides	No cost	Specify with <i>felt glides</i> .
Related Products	• Café and conference tables		▶ Page 334

Specification Information

Style Number	U.S. Base Prices													
	Fabric Grades:													
	COM	6	7	8	9	10	11	12	13	14	Leather Grades:			
											COL	C	E	

Wood Seat and Back Stacker

3500	\$864	N.A.	N.A.	N.A.	N.A.	N.A.	N.A.	N.A.	N.A.	N.A.	N.A.	N.A.	N.A.	N.A.
------	-------	------	------	------	------	------	------	------	------	------	------	------	------	------

▶ Specification Information, continued on next page

Enea Stacker With Arms

DESIGN JACOB LLUSCA DESIGN ORIGIN: SPAIN

 = Available in Rapid10.

► Specification Information, continued from previous page

Specification Information

Style Number	U.S. Base Prices											Leather Grades:		
	Fabric Grades:											COL	C	E
	COM	6	7	8	9	10	11	12	13	14				



Overall: 22½"D 22½"W 33¼"H
 Inside: 18"D 18"W 15¼"H
 Seat: 18"H
 Arm: 26¾"H

Upholstered Seat and Back

 3501	\$800	\$795	\$806	\$816	\$917	\$949	\$969	\$982	\$1108	\$1175	\$1050	\$1265	\$1392
--	-------	-------	-------	-------	-------	-------	-------	-------	--------	--------	--------	--------	--------

COM/yds = 1, COL/sq ft = 22



Overall: 22½"D 22½"W 33¼"H
 Inside: 18"D 18"W 15¼"H
 Seat: 18"H
 Arm: 26¾"H

Upholstered Seat and Wood Back

3502	\$868	\$868	\$874	\$880	\$894	\$928	\$961	\$982	\$1054	\$1144	\$1118	\$1224	\$1293
------	-------	-------	-------	-------	-------	-------	-------	-------	--------	--------	--------	--------	--------

COM/yds = ¾, COL/sq ft = 17



Overall: 22½"D 22½"W 33¼"H
 Inside: 18"D 18"W 15¼"H
 Seat: 18"H
 Arm: 26¾"H

Polypropylene Seat and Back

 3503	\$499	N.A.	N.A.	N.A.	N.A.	N.A.	N.A.	N.A.	N.A.	N.A.	N.A.	N.A.	N.A.
--	-------	------	------	------	------	------	------	------	------	------	------	------	------

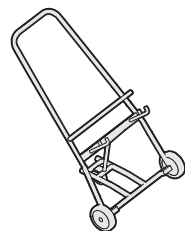

Overall: 34"D 26"W 34"H

Stacking Dolly

9014S	\$699	N.A.	N.A.	N.A.	N.A.	N.A.	N.A.	N.A.	N.A.	N.A.	N.A.	N.A.	N.A.
-------	-------	------	------	------	------	------	------	------	------	------	------	------	------



For Canadian Pricing
 Multiply U.S. Price by the
 Canadian price factor.
 ► See page 1 for details.

Enea Stacker Without Arms

DESIGN JACOB LLUSCA DESIGN ORIGIN: SPAIN

 = Available in Rapid10.

Tip: CAL 133 for polypropylene is available as a special quote. Polypropylene color will change slightly when FR treatment is applied. Contact Customer Service for availability and pricing. Minimum quantity will apply.

Tip: Due to the design and construction techniques of the Enea Chair only certain textiles can be successfully applied, therefore all COM fabrics must be submitted to Coalesse for approval prior to order acceptance.

Tip: Armless chairs stack nine high, chairs cannot be stacked with storage rack.

Tip: Fabrics and leathers will appear loose with comfort wrinkles when upholstered.

Tip: For Customer's Own Material or Leather, see necessary requirements, important processing instructions, and ordering information
 ► See Coalesse Surface Materials Reference Guide.

Tip: Contrasting fabric option available on model 3501S only.

Tip: Models 3501S and 3500S in black belt leather or wood are approved for CAL 133 at no charge.

Tip: Belt leather upcharge applies to COM pricing.

Tip: No tablet or ganging available on armless models.



Overall: 22½"D 18"W 33¼"H
 Inside: 18"D 18"W 15¼"H
 Seat: 18"H



For Canadian Pricing
 Multiply U.S. Price by the Canadian price factor.
 ► See page 1 for details.

Standard Includes	Required to Specify
-------------------	---------------------

<ul style="list-style-type: none"> • Frame: steel tubing • Seat and back: molded nylon, wood, or upholstery (wood is laminated layers of hard maple veneer) 	<ol style="list-style-type: none"> 1 Style number 2 Fabric or leather color number for upholstery, if selected 3 Plastic or wood finish color number for seat and back, if selected 4 Base/frame finish: black gloss, white gloss, and silver metallic 5 Options, if selected (see below) ► See Coalesse Surface Materials Reference Guide.
---	--

Options	U.S. Price	Required to Specify
---------	------------	---------------------

Surface Materials <ul style="list-style-type: none"> • Contrasting fabric 	+\$113 per fabric	Add suffix K to the style number and select fabric color number.
Fire code seating <ul style="list-style-type: none"> • CAL 133 	+\$113	Specify with CAL 133. ► See Coalesse Surface Materials Reference Guide.
Acrylic backer <ul style="list-style-type: none"> • Backer for chair with upholstered seat and back • Backer for chair with upholstered seat and wood back 	+\$ 17 +\$ 8	Specify with acrylic backer. ► See Coalesse Surface Materials Reference Guide.
Storage Rack <ul style="list-style-type: none"> • Storage rack 	+\$253	Specify with storage rack.
Belt Leather <ul style="list-style-type: none"> • Black belt leather available on model 3501S • White leather available on model 3501S 	-\$ 10 +\$ 30	Specify with black belt leather. Specify with white leather.
Felt Glides <ul style="list-style-type: none"> • Glides 	No cost	Specify with felt glides.
Related Products <ul style="list-style-type: none"> • Café and conference tables 		► Page 334

Specification Information

Style Number	U.S. Base Prices												Leather Grades:			
	Fabric Grades:												COL	C	E	
	COM	6	7	8	9	10	11	12	13	14						

Wood Seat and Back

3500S	\$762	N.A.	N.A.	N.A.	N.A.	N.A.	N.A.	N.A.	N.A.	N.A.	N.A.	N.A.	N.A.	N.A.	N.A.
-------	-------	------	------	------	------	------	------	------	------	------	------	------	------	------	------

► Specification Information, continued on next page

Enea Stacker Without Arms

DESIGN JACOB LLUSCA DESIGN ORIGIN: SPAIN

 = Available in Rapid10.

► Specification Information, continued from previous page

Specification Information

Style Number	U.S. Base Prices											Leather Grades:		
	Fabric Grades:											COL	C	E
	COM	6	7	8	9	10	11	12	13	14				



Overall: 22½"D 18"W 33¼"H
 Inside: 18"D 18"W 15¼"H
 Seat: 18"H

Upholstered Seat and Back

 3501S	\$703	\$714	\$724	\$740	\$757	\$772	\$816	\$854	\$925	\$988	\$ 946	\$1172	\$1290
COM/yds = 1, COL/sq ft = 22													



Overall: 22½"D 18"W 33¼"H
 Inside: 18"D 18"W 15¼"H
 Seat: 18"H

Upholstered Seat and Wood Back

3502S	\$765	\$756	\$760	\$765	\$777	\$781	\$809	\$825	\$863	\$945	\$1020	\$1115	\$1190
COM/yds = ¾, COL/sq ft = 17													



Overall: 22½"D 18"W 33¼"H
 Inside: 18"D 18"W 15¼"H
 Seat: 18"H

Polypropylene Seat and Back

 3503S	\$464	N.A.	N.A.	N.A.	N.A.	N.A.	N.A.	N.A.	N.A.	N.A.	N.A.	N.A.	N.A.
---	-------	------	------	------	------	------	------	------	------	------	------	------	------

Stacking Dolly

Overall: 34"D 26"W 34"H	9014S	\$699	N.A.	N.A.	N.A.	N.A.	N.A.	N.A.	N.A.	N.A.	N.A.	N.A.	N.A.
-------------------------	-------	-------	------	------	------	------	------	------	------	------	------	------	------

For Canadian Pricing
 Multiply U.S. Price by the
 Canadian price factor.
 ► See page 1 for details.

Enea Bar-Height Stools with Arms

DESIGN JACOB LLUSCA DESIGN ORIGIN: SPAIN

 = Available in Rapid10.

Tip: CAL 133 for polypropylene is available as a special quote. Polypropylene color will change slightly when FR treatment is applied. Contact Customer Service for availability and pricing. Minimum quantity will apply.

Tip: Due to the design and construction techniques of the Enea Barstool only certain textiles can be successfully applied, therefore all COM fabrics must be submitted to Coalesse for approval prior to order acceptance.

Tip: Pricing based on highest grade textile specified.

Tip: Fabrics and leathers will appear loose with comfort wrinkles when upholstered.

Tip: Contrasting fabric option available on model 3511 only.

Tip: For Customer's Own Material or Leather, see necessary requirements, important processing instructions, and ordering information
 ▶ See *Coalesse Surface Materials Reference Guide*.

Tip: Models 3510, 3511, and 3512 are approved for CAL 133 at no charge.

Tip: Belt leather upcharge applies to COM pricing.

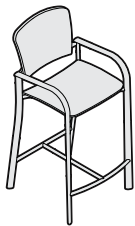

Overall: 24¾" D 22¼" W 45½" H
 Inside: 18½" D 17¾" W 15¼" H
 Seat: 30½" H
 Arm: 39¼" H



For Canadian Pricing
 Multiply U.S. Price by the Canadian price factor.
 ▶ See page 1 for details.

Standard Includes	Required to Specify
<ul style="list-style-type: none"> Constructed of steel tubing with cast aluminum arms Seat and back: polypropylene, wood, or upholstery (wood is laminated layers of hard maple veneer) Foot rest with leg stretchers: chrome-plated 	<ol style="list-style-type: none"> Style number Number of fabrics if contrasting fabric style number is selected Fabric or leather color number for upholstery, if selected Plastic or wood finish color number for seat and back, if selected Base/frame finish: black gloss, white gloss, and silver metallic Options, if selected (see below) ▶ See <i>Coalesse Surface Materials Reference Guide</i> .

Options	U.S. Price	Required to Specify
Surface Materials <ul style="list-style-type: none"> Contrasting fabric 	+\$ 113 per fabric	Add suffix K to the style number and select fabric color number.
Fire code seating <ul style="list-style-type: none"> CAL 133 	+\$ 113	Specify with CAL 133. ▶ See <i>Coalesse Surface Materials Reference Guide</i> .
Acrylic backer <ul style="list-style-type: none"> Backer for chair with upholstered seat and back Backer for chair with upholstered seat and wood back 	+\$ 12 +\$ 6	Specify with acrylic backer. ▶ See <i>Coalesse Surface Materials Reference Guide</i> .
Belt Leather <ul style="list-style-type: none"> Hand-stitched black belt leather seat and back available on model 3511 Hand-stitched white leather seat and back available on model 3511 	-\$ 3 +\$ 41	Specify with black belt leather. Specify with white leather.
Felt Glides <ul style="list-style-type: none"> Glides 	No cost	Specify with felt glides.
Related Products <ul style="list-style-type: none"> Café and conference tables 		▶ Page 334

Style Number	U.S. Base Prices												Leather Grades:		
	Fabric Grades:												COL	C	E
	COM	6	7	8	9	10	11	12	13	14					

Wood Seat and Back

3510	\$939	N.A.	N.A.	N.A.	N.A.	N.A.	N.A.	N.A.	N.A.	N.A.	N.A.	N.A.	N.A.	N.A.
------	-------	------	------	------	------	------	------	------	------	------	------	------	------	------

▶ Specification Information, continued on next page

Enea Bar-Height Stools with Arms

DESIGN JACOB LLUSCA DESIGN ORIGIN: SPAIN

 = Available in Rapid10.

► Specification Information, continued from previous page

Specification Information

Style Number	U.S. Base Prices											Leather Grades:		
	Fabric Grades:											COL	C	E
	COM	6	7	8	9	10	11	12	13	14				

Upholstered Seat and Back

3511	\$875	\$894	\$905	\$918	\$92	\$1024	\$1044	\$1057	\$1110	\$1196	\$1137	\$1365	\$1496
------	-------	-------	-------	-------	------	--------	--------	--------	--------	--------	--------	--------	--------

COM/yds = 1, COL/sq ft = 22

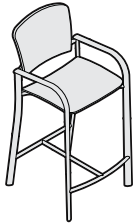

Overall: 24¾"D 22¼"W 45½"H
 Inside: 18½"D 17¾"W 15¼"H
 Seat: 30½"H
 Arm: 39¼"H

Upholstered Seat and Wood Back

3512	\$949	\$933	\$941	\$946	\$957	\$ 963	\$ 985	\$1009	\$1049	\$1156	\$1206	\$1325	\$1400
------	-------	-------	-------	-------	-------	--------	--------	--------	--------	--------	--------	--------	--------

COM/yds = ¾, COL/sq ft = 17

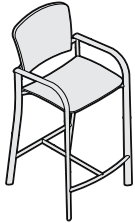

Overall: 24¾"D 22¼"W 45½"H
 Inside: 18½"D 17¾"W 15¼"H
 Seat: 30½"H
 Arm: 39¼"H

Polypropylene Seat and Back

 3513	\$644	N.A.	N.A.	N.A.	N.A.	N.A.	N.A.	N.A.	N.A.	N.A.	N.A.	N.A.	N.A.
--	-------	------	------	------	------	------	------	------	------	------	------	------	------

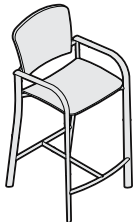

Overall: 24¾"D 22¼"W 45½"H
 Inside: 18½"D 17¾"W 15¼"H
 Seat: 30½"H
 Arm: 39¼"H

For Canadian Pricing
 Multiply U.S. Price by the
 Canadian price factor.
 ► See page 1 for details.

Enea Bar-Height Stools without Arms

DESIGN JACOB LLUSCA DESIGN ORIGIN: SPAIN

 = Available in Rapid10.

Tip: CAL 133 for polypropylene is available as a special quote. Polypropylene color will change slightly when FR treatment is applied. Contact Customer Service for availability and pricing. Minimum quantity will apply.

Tip: Due to the design and construction techniques of the Enea Barstool only certain textiles can be successfully applied, therefore all COM fabrics must be submitted to Coalesse for approval prior to order acceptance.

Tip: Pricing based on highest grade textile specified.

Tip: Fabrics and leathers will appear loose with comfort wrinkles when upholstered.

Tip: For Customer's Own Material or Leather, see necessary requirements, important processing instructions, and ordering information
 ▶ See *Coalesse Surface Materials Reference Guide*.

Tip: Contrasting fabric option available on model 3511S only.

Tip: Models 3510S, 3511S, and 3512S are approved for CAL 133 at no charge.

Tip: Belt leather upcharge applies to COM pricing.

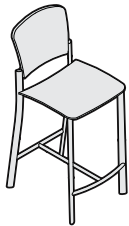

Overall: 25"D 18½"W 45¾"H
Inside: 18½"D 17¾"W 15¼"H
Seat: 30½"H



For Canadian Pricing
 Multiply U.S. Price by the Canadian price factor.
 ▶ See page 1 for details.

Standard Includes	Required to Specify
<ul style="list-style-type: none"> Constructed of steel tubing with cast aluminum arms Seat and back: polypropylene, wood, or upholstery (wood is laminated layers of hard maple veneer) Foot rest with leg stretchers: chrome-plated 	<ol style="list-style-type: none"> Style number Number of fabrics if contrasting fabric style number is selected Fabric or leather color number for upholstery, if selected Plastic or wood finish color number for seat and back, if selected Base/frame finish: black gloss, white gloss, and silver metallic Options, if selected (see below) ▶ See <i>Coalesse Surface Materials Reference Guide</i> .

Options	U.S. Price	Required to Specify
Surface Materials <ul style="list-style-type: none"> Contrasting fabric 	+\$113 per fabric	Add suffix K to the style number and select fabric color number.
Fire code seating <ul style="list-style-type: none"> CAL 133 	+\$113	Specify with CAL 133. ▶ See <i>Coalesse Surface Materials Reference Guide</i> .
Acrylic backer <ul style="list-style-type: none"> Backer for chair with upholstered seat and back Backer for chair with upholstered seat and wood back 	+\$ 12 +\$ 6	Specify with acrylic backer. ▶ See <i>Coalesse Surface Materials Reference Guide</i> .
Belt Leather <ul style="list-style-type: none"> Hand-stitched black belt leather seat and back available on model 3511S Hand-stitched white leather seat and back available on model 3511S 	-\$ 3 +\$ 41	Specify with black belt leather. Specify with white leather.
Felt Glides <ul style="list-style-type: none"> Glides 	No cost	Specify with felt glides.
Related Products <ul style="list-style-type: none"> Café and conference tables 		▶ Page 334

Style Number	U.S. Base Prices												Leather Grades:		
	Fabric Grades:												COL	C	E
	COM	6	7	8	9	10	11	12	13	14					

Wood Seat and Back

3510S	\$911	N.A.	N.A.	N.A.	N.A.	N.A.	N.A.	N.A.	N.A.	N.A.	N.A.	N.A.	N.A.	N.A.
-------	-------	------	------	------	------	------	------	------	------	------	------	------	------	------

▶ Specification Information, continued on next page

Enea Bar-Height Stools without Arms

DESIGN JACOB LLUSCA DESIGN ORIGIN: SPAIN

 = Available in Rapid10.

► Specification Information, continued from previous page

Specification Information

Style Number	U.S. Base Prices											Leather Grades:		
	Fabric Grades:											COL	C	E
	COM	6	7	8	9	10	11	12	13	14				

Upholstered Seat and Back

3511S	\$803	\$817	\$833	\$851	\$868	\$890	\$924	\$959	\$1038	\$1115	\$1070	\$1299	\$1430
-------	-------	-------	-------	-------	-------	-------	-------	-------	--------	--------	--------	--------	--------

COM/yds = 1, COL/sq ft = 22

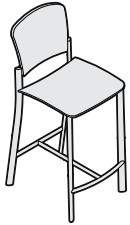

Overall: 25"D 18½"W 45¾"H
 Inside: 18½"D 17¾"W 15¼"H
 Seat: 30½"H

Upholstered Seat and Wood Back

3512S	\$875	\$867	\$872	\$877	\$894	\$899	\$918	\$935	\$ 979	\$1078	\$1137	\$1246	\$1319
-------	-------	-------	-------	-------	-------	-------	-------	-------	--------	--------	--------	--------	--------

COM/yds = ¾, COL/sq ft = 17

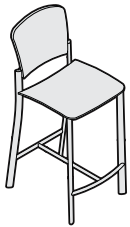

Overall: 25"D 18½"W 45¾"H
 Inside: 18½"D 17¾"W 15¼"H
 Seat: 30½"H

Polypropylene Seat and Back

 3513S	\$558	N.A.	N.A.	N.A.	N.A.	N.A.	N.A.	N.A.	N.A.	N.A.	N.A.	N.A.	N.A.
---	-------	------	------	------	------	------	------	------	------	------	------	------	------

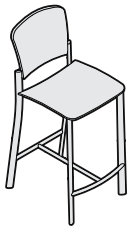

Overall: 25"D 18½"W 45¾"H
 Inside: 18½"D 17¾"W 15¼"H
 Seat: 30½"H

For Canadian Pricing
 Multiply U.S. Price by the
 Canadian price factor.
 ► See page 1 for details.

Enea Café Stool with Back

DESIGN JACOB LLUSCA DESIGN ORIGIN: SPAIN

 = Available in Rapid10.



Tip: CAL 133 for polypropylene is available as a special quote. Polypropylene color will change slightly when FR treatment is applied. Contact Customer Service for availability and pricing. Minimum quantity will apply.

Tip: For Customer's Own Material or Leather, see necessary requirements, important processing instructions, and ordering information
 ► See *Coalesse Surface Materials Reference Guide*.

Tip: Fabrics and leathers will appear loose with comfort wrinkles when upholstered.

Tip: Belt leather upcharge applies to COM pricing.

Standard Includes		Required to Specify	
	<ul style="list-style-type: none"> • Base/frame: steel tubing and base with non-skid strip • Seat and back: molded polypropylene, wood, or upholstery (wood is laminated layers of hard maple veneer) • Footrest: polished aluminum • Upholstered seat / back: Laminations of multiple density polyurethane foam and polyester fiber 		<ol style="list-style-type: none"> 1 Style number 2 Number of fabrics if contrasting fabric style number is selected 3 Fabric or leather color number for upholstery, if selected 4 Plastic or wood finish color number for seat and back, if selected 5 Base/frame finish: black gloss, white gloss, and silver metallic 6 Options, if selected (see below) ► See <i>Coalesse Surface Materials Reference Guide</i> .
Options		U.S. Price	Required to Specify
Surface Materials	<ul style="list-style-type: none"> • Contrasting fabric 	+\$ 113 per fabric	Add suffix K to the style number and select fabric color number.
	Fire code seating <ul style="list-style-type: none"> • CAL 133 	+\$ 113	Specify with CAL 133. ► See <i>Coalesse Surface Materials Reference Guide</i> .
	Acrylic backer <ul style="list-style-type: none"> • Backer for stool with upholstered seat and back • Backer for stool with upholstered seat and wood back 	+\$ 6 +\$ 4	Specify with acrylic backer. Specify with acrylic backer. ► See <i>Coalesse Surface Materials Reference Guide</i> .
Belt Leather	<ul style="list-style-type: none"> • Hand-stitched black belt leather seat and back available on model H351-SB2719 	+\$ 87	Specify with black belt leather.
	<ul style="list-style-type: none"> • Hand-stitched black belt leather seat and back available on model H351-SB3119 	+\$ 94	Specify with black belt leather.
	<ul style="list-style-type: none"> • Hand-stitched white leather seat and back available on model H351-SB2719 	+\$130	Specify with white leather.
	<ul style="list-style-type: none"> • Hand-stitched white leather seat and back available on model H351-SB3119 	+\$135	Specify with white leather.
Related Products	<ul style="list-style-type: none"> • Café and conference tables 		► Page 334



For Canadian Pricing
 Multiply U.S. Price by the Canadian price factor.
 ► See page 1 for details.

Enea Café Stool with Back

DESIGN JACOB LLUSCA DESIGN ORIGIN: SPAIN

 = Available in Rapid10.

Specification Information

Style Number	U.S. Base Prices														Leather Grades:			Wood	Poly-Propylene
	Fabric Grades:														COL	C	E		
	COM	6	7	8	9	10	11	12	13	14									

Café Counter-Height Stool, 19" Base

Upholstered Seat and Back

 H351-SB2719	\$ 988	\$ 972	\$ 980	\$ 985	\$ 996	\$1002	\$1031	\$1048	\$1083	\$1189	\$1221	\$1450	\$1501	N.A.	N.A.
---	--------	--------	--------	--------	--------	--------	--------	--------	--------	--------	--------	--------	--------	------	------

COM/yds = 3/4, COL/sq ft = 13 1/2

Upholstered Seat with Wood Back

H352-SB2719	\$1042	\$1026	\$1034	\$1039	\$1050	\$1056	\$1090	\$1107	\$1137	\$1250	\$1275	\$1435	\$1469	N.A.	N.A.
-------------	--------	--------	--------	--------	--------	--------	--------	--------	--------	--------	--------	--------	--------	------	------

COM/yds = 5/8, COL/sq ft = 10

Café Bar-Height Stool, 19" Base

Upholstered Seat and Back

 H351-SB3119	\$ 993	\$ 977	\$ 985	\$ 990	\$1001	\$1007	\$1036	\$1053	\$1088	\$1195	\$1226	\$1455	\$1506	N.A.	N.A.
---	--------	--------	--------	--------	--------	--------	--------	--------	--------	--------	--------	--------	--------	------	------

COM/yds = 3/4, COL/sq ft = 13 1/2

Upholstered Seat with Wood Back

H352-SB3119	\$1047	\$1031	\$1039	\$1044	\$1055	\$1061	\$1095	\$1112	\$1142	\$1256	\$1280	\$1440	\$1480	N.A.	N.A.
-------------	--------	--------	--------	--------	--------	--------	--------	--------	--------	--------	--------	--------	--------	------	------

Café Counter-Height Stool, 19" Base

Wood Seat and Back

H350-SB2719	N.A.	N.A.	N.A.	N.A.	N.A.	N.A.	N.A.	N.A.	N.A.	N.A.	N.A.	N.A.	N.A.	\$1063	N.A.
-------------	------	------	------	------	------	------	------	------	------	------	------	------	------	--------	------

Polypropylene Seat and Back

H353-SB2719	N.A.	N.A.	N.A.	N.A.	N.A.	N.A.	N.A.	N.A.	N.A.	N.A.	N.A.	N.A.	N.A.	N.A.	\$799
-------------	------	------	------	------	------	------	------	------	------	------	------	------	------	------	-------

Café Bar-Height Stool, 19" Base

Wood Seat and Back

H350-SB3119	N.A.	N.A.	N.A.	N.A.	N.A.	N.A.	N.A.	N.A.	N.A.	N.A.	N.A.	N.A.	N.A.	\$1071	N.A.
-------------	------	------	------	------	------	------	------	------	------	------	------	------	------	--------	------

Polypropylene Seat and Back

H353-SB3119	N.A.	N.A.	N.A.	N.A.	N.A.	N.A.	N.A.	N.A.	N.A.	N.A.	N.A.	N.A.	N.A.	N.A.	\$805
-------------	------	------	------	------	------	------	------	------	------	------	------	------	------	------	-------



Overall: 19"D 19"W 38 1/4"H
Inside: 14 1/4"D 17"W 12 5/8"H
Seat: 25 5/8"H



Overall: 19"D 19"W 42 1/4"H
Inside: 14 1/4"D 17"W 12 5/8"H
Seat: 29 5/8"H



Overall: 19"D 19"W 38 1/4"H
Inside: 14 1/4"D 17"W 12 5/8"H
Seat: 25 5/8"H



Overall: 19"D 19"W 42 1/4"H
Inside: 14 1/4"D 17"W 12 5/8"H
Seat: 29 5/8"H

 **For Canadian Pricing**
Multiply U.S. Price by the Canadian price factor.
▶ See page 1 for details.

Guest/Slider/Stack Seating

Enea Café Stools

DESIGN JACOB LLUSCA DESIGN ORIGIN: SPAIN

Tip: CAL 133 for polypropylene is available as a special quote. Polypropylene color will change slightly when FR treatment is applied. Contact Customer Service for availability and pricing. Minimum quantity will apply.

Tip: Due to the design and construction techniques of the Enea Barstool only certain textiles can be successfully applied, therefore all COM fabrics must be submitted to Coalesse for approval prior to order acceptance.

Tip: Recommended leathers are Elmosoft Grade C and Elmorustical Grade E.

Tip: Belt leather upcharge applies to COM pricing.

Tip: Special color match, consult Customer Service.

Tip: For Customer's Own Material or Leather, see necessary requirements, important processing instructions, and ordering information
▶ See *Coalesse Surface Materials Reference Guide*.

Tip: Fabrics and leathers will appear loose with comfort wrinkles when upholstered.

Standard Includes	Required to Specify
<ul style="list-style-type: none"> • Base/Frame: steel tubing and base with non-skid strip • Seat and back: molded polypropylene, wood, or upholstery (wood is laminated layers of hard maple veneer) • Footrest: Polished aluminum • Base/Frame Finishes: BKG = Black Gloss SM = Silver Metallic WH = White • Upholstered Seat / Back: Laminations of multiple density polyurethane foam and polyester fiber 	<ol style="list-style-type: none"> 1 Style number 2 Plastic color number for seat and back 3 Fabric or leather color number for upholstery 4 Base/frame finish: black gloss, white gloss, and silver metallic 5 Options, if selected (see below) ▶ See <i>Coalesse Surface Materials Reference Guide</i> .

Options	U.S. Price	Required to Specify
Surface Materials <ul style="list-style-type: none"> • Fire code seating • CAL 133 	+\$113	Specify with <i>CAL 133</i> . ▶ See <i>Coalesse Surface Materials Reference Guide</i> .
<ul style="list-style-type: none"> • Acrylic backer • Backer 	+\$ 4	Specify with <i>acrylic backer</i> . ▶ See <i>Coalesse Surface Materials Reference Guide</i> .
Belt Leather <ul style="list-style-type: none"> • Hand-stitched black belt leather seat and back available on model H352-S19 • Hand-stitched black belt leather seat available on model H352-S27 and H352-S31 • Hand-stitched white belt leather seat available on model H352-S19 • Hand-stitched white belt leather seat available on model H352-S27 and HS32-S31 	-\$ 8 -\$ 3 +\$ 35 +\$ 41	Specify with <i>black belt leather</i> . Specify with <i>black belt leather</i> . Specify with <i>white leather</i> . Specify with <i>white leather</i> .
Related Products <ul style="list-style-type: none"> • Café and conference tables 		▶ Page 334

Style Number	U.S. Base Prices												Leather Grades:		
	Fabric Grades:												COL	C	E
	COM	6	7	8	9	10	11	12	13	14					

Low Stool with Upholstered Seat

H352-S19	\$772	\$751	\$756	\$764	\$774	\$780	\$791	\$802	\$839	\$928	\$902	\$1086	\$1126
----------	-------	-------	-------	-------	-------	-------	-------	-------	-------	-------	-------	--------	--------

COM/yds = 5/9, COL/sq ft = 10

Café Counter-Height Stool with Upholstered Seat

H352-S27	\$803	\$787	\$795	\$800	\$805	\$811	\$822	\$846	\$876	\$966	\$938	\$1123	\$1157
----------	-------	-------	-------	-------	-------	-------	-------	-------	-------	-------	-------	--------	--------

COM/yds = 5/9, COL/sq ft = 10

▶ Specification Information, continued on next page

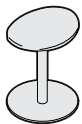

Overall: 14½"D 17"W 19¼"H
Seat: 17⅝"H



Overall: 14½"D 17"W 27¼"H
Seat: 25⅝"H

Enea Café Stools

DESIGN JACOB LLUSCA DESIGN ORIGIN: SPAIN

► Specification Information, continued from previous page

Specification Information

Style Number	U.S. Base Prices														Leather Grades:			Wood	Poly-Propylene
	Fabric Grades:														COL	C	E		
	COM	6	7	8	9	10	11	12	13	14									

Café Bar-Height Stool with Upholstered Seat

H352-S31	\$840	\$824	\$824	\$837	\$848	\$854	\$864	\$876	\$907	\$1003	\$970	\$1154	\$1194	N.A.	N.A.
----------	-------	-------	-------	-------	-------	-------	-------	-------	-------	--------	-------	--------	--------	------	------

COM/yds = 5%, COL/sq ft = 10

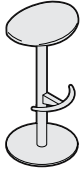

Overall: 14½"D 17"W 31¼"H
Seat: 29⅝"H

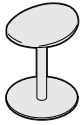

Overall: 14½"D 17"W 19¼"H
Seat: 17⅝"H

Low Stool

Wood Seat

H350-S19	N.A.	N.A.	N.A.	N.A.	N.A.	N.A.	N.A.	N.A.	N.A.	N.A.	N.A.	N.A.	N.A.	\$699	N.A.
----------	------	------	------	------	------	------	------	------	------	------	------	------	------	-------	------

Polypropylene Seat

H353-S19	N.A.	N.A.	N.A.	N.A.	N.A.	N.A.	N.A.	N.A.	N.A.	N.A.	N.A.	N.A.	N.A.	N.A.	\$549
----------	------	------	------	------	------	------	------	------	------	------	------	------	------	------	-------

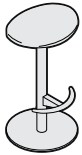

Overall: 14½"D 17"W 27¼"H
Seat: 25⅝"H

Café Counter-Height Stool

Wood Seat

H350-S27	N.A.	N.A.	N.A.	N.A.	N.A.	N.A.	N.A.	N.A.	N.A.	N.A.	N.A.	N.A.	N.A.	\$734	N.A.
----------	------	------	------	------	------	------	------	------	------	------	------	------	------	-------	------

Polypropylene Seat

H353-S27	N.A.	N.A.	N.A.	N.A.	N.A.	N.A.	N.A.	N.A.	N.A.	N.A.	N.A.	N.A.	N.A.	N.A.	\$610
----------	------	------	------	------	------	------	------	------	------	------	------	------	------	------	-------

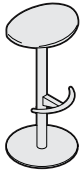

Overall: 14½"D 17"W 31¼"H
Seat: 29⅝"H

Café Bar-Height Stool

Wood Seat

H350-S31	N.A.	N.A.	N.A.	N.A.	N.A.	N.A.	N.A.	N.A.	N.A.	N.A.	N.A.	N.A.	N.A.	\$765	N.A.
----------	------	------	------	------	------	------	------	------	------	------	------	------	------	-------	------

Polypropylene Seat

H353-S31	N.A.	N.A.	N.A.	N.A.	N.A.	N.A.	N.A.	N.A.	N.A.	N.A.	N.A.	N.A.	N.A.	N.A.	\$664
----------	------	------	------	------	------	------	------	------	------	------	------	------	------	------	-------

Guest/Slider/Stack Seating

 **For Canadian Pricing**
Multiply U.S. Price by the
Canadian price factor.
► See page 1 for details.

Enea Lottus Armless Chairs

DESIGN LIEVORE ALTHERR MOLINA DESIGN ORIGIN: SPAIN

Tip: For Customer's Own Material or Leather, see necessary requirements, important processing instructions, and ordering information
 ▶ See *Coalesse Surface Materials Reference Guide*.

Tip: CAL133 for polypropylene and fire code seating are available as a special quote. Polypropylene color will change slightly when FR treatment is applied. Contact customer service for availability and pricing. Minimum quantity will apply.

Standard Includes	Required to Specify
<ul style="list-style-type: none"> • Base and frame constructed of steel tubing • Seat and back: polypropylene • Insert, if selected: polypropylene or upholstery 	1 Style number 2 Plastic color number for seat and back: 003 White 0013 Sunset Orange 0014 Clover Green 0015 Sand 0016 Walnut Brown 0017 Cool Grey 0414 Anthracite Grey 0421 Blue 400 Black 409 Red 3 Fabric or leather color number for upholstery insert, if selected 4 Paint color number for base and frame: 4016 White 4017 Black 4216 Red 4217 Brown 4218 Platinum Silver 5 Options, if selected (see below) ▶ See <i>Coalesse Surface Materials Reference Guide</i> .

Options	U.S. Price	Required to Specify
Surface Materials • Acrylic backer • Backer for chair with upholstered insert	+ \$6	Specify with acrylic backer. ▶ See <i>Coalesse Surface Materials Reference Guide</i> .
Felt Glides • Glides	No cost	Specify with felt glides.
Related Products • Café and conference tables		▶ Page 334

Specification Information														
Style Number	U.S. Base Prices													
	Fabric Grades:													
	COM	6	7	8	9	10	11	12	13	14	Leather Grades:			Poly-propylene
											COL	C	E	

Armless Chair with No Insert

COEL100	\$329	N.A.	N.A.	N.A.	N.A.	N.A.	N.A.	N.A.	N.A.	N.A.	N.A.	N.A.	N.A.	N.A.
---------	-------	------	------	------	------	------	------	------	------	------	------	------	------	------

Armless Chair with Polypropylene Insert

COEL100INSERT	N.A.	N.A.	N.A.	N.A.	N.A.	N.A.	N.A.	N.A.	N.A.	N.A.	N.A.	N.A.	N.A.	N.A.	\$368
---------------	------	------	------	------	------	------	------	------	------	------	------	------	------	------	-------

▶ Specification Information, continued on next page



Overall: 20¾"D 20¾"W 30½"H
 Seat: 18"H



Overall: 20¾"D 20¾"W 30½"H
 Seat: 18"H

 **For Canadian Pricing**
 Multiply U.S. Price by the Canadian price factor.
 ▶ See page 1 for details.

Enea Lottus Armless Chairs

DESIGN LIEVORE ALTHERR MOLINA DESIGN ORIGIN: SPAIN

► Specification Information, continued from previous page

Specification Information

Style Number	U.S. Base Prices														Leather Grades:			Polypropylene
	Fabric Grades:														COL	C	E	
	COM	6	7	8	9	10	11	12	13	14								

Armless Chair with Upholstered Insert

COEL100UPH	\$493	\$474	\$485	\$494	\$513	\$529	\$540	\$547	\$580	\$626	\$709	\$720	\$749	N.A.
COM/yds = ¾, COL/sq ft = 15														



Overall: 20¾"D 20¾"W 30½"H
Seat: 18"H

Specification Information

Style Number	U.S. Price
--------------	------------

Stacking Dolly

COELDOLLY	\$693
-----------	-------

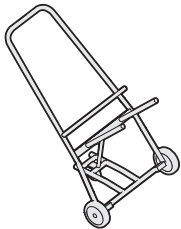

Tip: Dolly can be used with any Enea Lottus chair.

Tip: Armless chair stacks 10 high on dolly.

Tip: Cantilever arm chair stacks six high on dolly.

Tip: Loop arm chair stacks six high on dolly.

Guest/Slide/Stack Seating



For Canadian Pricing
Multiply U.S. Price by the Canadian price factor.
► See page 1 for details.

Enea Lottus Cantilever Arm Chairs

DESIGN LIEVORE ALTHERR MOLINA DESIGN ORIGIN: SPAIN

Tip: Cantilever arm can hook on table to provide storing option.

Tip: Cantilever arm stacks 6 high.

Tip: Can specify arm cap in any plastic color for Lottus.

Tip: For Customer's Own Material or Leather, see necessary requirements, important processing instructions, and ordering information
 ▶ See *Coalesse Surface Materials Reference Guide*.

Tip: CAL133 for polypropylene and fire code seating are available as a special quote. Polypropylene color will change slightly when FR treatment is applied. Contact customer service for availability and pricing. Minimum quantity will apply.

Standard Includes	Required to Specify
-------------------	---------------------

- Base and frame constructed of steel tubing
- Seat and back: polypropylene
- Arm cap: polypropylene
- Insert, if selected: polypropylene or upholstery

- 1 Style number
- 2 Plastic color number for seat, back, and arm cap:
 - 003 White
 - 0013 Sunset Orange
 - 0014 Clover Green
 - 0015 Sand
 - 0016 Walnut Brown
 - 0017 Cool Grey
 - 0414 Anthracite Grey
 - 0421 Blue
 - 400 Black
 - 409 Red
- 3 Fabric or leather color number for upholstery insert, if selected
- 4 Paint color number for base and frame:
 - 4016 White
 - 4017 Black
 - 4216 Red
 - 4217 Brown
 - 4218 Platinum Silver
- 5 Options, if selected (see below)
 ▶ See *Coalesse Surface Materials Reference Guide*.

	Options	U.S. Price	Required to Specify
--	---------	------------	---------------------

Surface Materials	Acrylic backer • Backer for chair with upholstered insert	+\$6	Specify with acrylic backer. ▶ See <i>Coalesse Surface Materials Reference Guide</i> .
Felt Glides	• Glides	No cost	Specify with felt glides.
Related Products	• Café and conference tables		▶ Page 334

Specification Information

Style Number	U.S. Base Prices														Leather Grades:			Polypropylene
	Fabric Grades:														COL	C	E	
	COM	6	7	8	9	10	11	12	13	14								

Cantilever Arm Chair with No Insert

COEL200	\$406	N.A.	N.A.	N.A.	N.A.	N.A.	N.A.	N.A.	N.A.	N.A.	N.A.	N.A.	N.A.	N.A.	N.A.	N.A.
---------	-------	------	------	------	------	------	------	------	------	------	------	------	------	------	------	------



Overall: 20¾"D 23¾"W 30½"H
 Seat: 18"H
 Arm: 26"H

Cantilever Arm Chair with Polypropylene Insert

COEL200INSERT	N.A.	N.A.	N.A.	N.A.	N.A.	N.A.	N.A.	N.A.	N.A.	N.A.	N.A.	N.A.	N.A.	N.A.	N.A.	N.A.	\$444
---------------	------	------	------	------	------	------	------	------	------	------	------	------	------	------	------	------	-------

▶ Specification Information, continued on next page



Overall: 20¾"D 23¾"W 30½"H
 Seat: 18"H
 Arm: 26"H

Enea Lottus Cantilever Arm Chairs

DESIGN LIEVORE ALTHERR MOLINA DESIGN ORIGIN: SPAIN

► Specification Information, continued from previous page

Specification Information

Style Number	U.S. Base Prices														Leather Grades:			Polypropylene
	Fabric Grades:														COL	C	E	
	COM	6	7	8	9	10	11	12	13	14								

Cantilever Arm Chair with Upholstered Insert

COEL200UPH	\$568	\$549	\$560	\$569	\$588	\$604	\$615	\$622	\$655	\$701	\$784	\$795	\$824	N.A.
------------	-------	-------	-------	-------	-------	-------	-------	-------	-------	-------	-------	-------	-------	------

COM/yds = ¾, COL/sq ft = 15



Overall: 20¾"D 23¾"W 30½"H
 Seat: 18"H
 Arm: 26"H



For Canadian Pricing
 Multiply U.S. Price by the
 Canadian price factor.
 ► See page 1 for details.

Enea Lottus Aluminum Loop Arm Chairs

DESIGN LIEVORE ALTHERR MOLINA DESIGN ORIGIN: SPAIN

Tip: Arm chair stacks six high.

Tip: For Customer's Own Material or Leather, see necessary requirements, important processing instructions, and ordering information

► See *Coalesse Surface Materials Reference Guide*.

Tip: CAL133 for polypropylene and fire code seating are available as a special quote. Polypropylene color will change slightly when FR treatment is applied. Contact customer service for availability and pricing. Minimum quantity will apply.

Standard Includes	Required to Specify
<ul style="list-style-type: none"> • Base and frame constructed of steel tubing • Seat and back: polypropylene • Arm: aluminum • Insert, if selected: polypropylene or upholstery 	<ol style="list-style-type: none"> 1 Style number 2 Plastic color number for seat, back, and arm cap: <ul style="list-style-type: none"> 003 White 0013 Sunset Orange 0014 Clover Green 0015 Sand 0016 Walnut Brown 0017 Cool Grey 0414 Anthracite Grey 0421 Blue 400 Black 409 Red 3 Fabric or leather color number for upholstery insert, if selected 4 Paint color number for base and frame: <ul style="list-style-type: none"> 4016 White 4017 Black 4216 Red 4217 Brown 4218 Platinum Silver 5 Options, if selected (see below) <p>► See <i>Coalesse Surface Materials Reference Guide</i>.</p>

Options	U.S. Price	Required to Specify
Surface Materials <ul style="list-style-type: none"> • Acrylic backer • Backer for chair with upholstered insert 	+\$6	Specify with acrylic backer. ► See <i>Coalesse Surface Materials Reference Guide</i> .
Felt Glides <ul style="list-style-type: none"> • Glides 	No cost	Specify with felt glides.
Related Products <ul style="list-style-type: none"> • Café and conference tables 		► Page 334

Specification Information															
Style Number	U.S. Base Prices													Leather Grades:	Polypropylene
	Fabric Grades:														
	COM	6	7	8	9	10	11	12	13	14					

Aluminum Loop Arm Chair with No Insert

COEL300	\$438	N.A.	N.A.	N.A.	N.A.	N.A.	N.A.	N.A.	N.A.	N.A.	N.A.	N.A.	N.A.	N.A.
---------	-------	------	------	------	------	------	------	------	------	------	------	------	------	------



Aluminum Loop Arm Chair with Polypropylene Insert

COEL300INSERT	N.A.	N.A.	N.A.	N.A.	N.A.	N.A.	N.A.	N.A.	N.A.	N.A.	N.A.	N.A.	N.A.	N.A.	\$476
---------------	------	------	------	------	------	------	------	------	------	------	------	------	------	------	-------

► Specification Information, continued on next page



 **For Canadian Pricing**
 Multiply U.S. Price by the Canadian price factor.
 ► See page 1 for details.

Enea Lottus Aluminum Loop Arm Chairs

DESIGN LIEVORE ALTHERR MOLINA DESIGN ORIGIN: SPAIN

► Specification Information, continued from previous page

Specification Information

Style Number	U.S. Base Prices														Leather Grades:			Polypropylene
	Fabric Grades:														COL	C	E	
	COM	6	7	8	9	10	11	12	13	14								

Aluminum Loop Arm Chair with Upholstered Insert

COEL300UPH	\$601	\$582	\$593	\$602	\$621	\$637	\$648	\$655	\$688	\$734	\$817	\$828	\$857	N.A.
------------	-------	-------	-------	-------	-------	-------	-------	-------	-------	-------	-------	-------	-------	------

COM/yds = ¾, COL/sq ft = 15



For Canadian Pricing
 Multiply U.S. Price by the
 Canadian price factor.
 ► See page 1 for details.

Enea Lottus Sled Base Stools

DESIGN LIEVORE ALTHERR MOLINA DESIGN ORIGIN: SPAIN

Tip: For Customer's Own Material or Leather, see necessary requirements, important processing instructions, and ordering information
 ▶ See *Coalesse Surface Materials Reference Guide*.

Tip: CAL133 for polypropylene and fire code seating are available as a special quote. Polypropylene color will change slightly when FR treatment is applied. Contact customer service for availability and pricing. Minimum quantity will apply.

Standard Includes	Required to Specify
-------------------	---------------------

- Base and frame constructed of steel tubing
- Seat and back: polypropylene
- Insert, if selected: Polypropylene or upholstery

- 1 Style number
 - 2 Plastic color number for seat and back:
 - 003 White
 - 0013 Sunset Orange
 - 0014 Clover Green
 - 0015 Sand
 - 0016 Walnut Brown
 - 0017 Cool Grey
 - 0414 Anthracite Grey
 - 0421 Blue
 - 400 Black
 - 409 Red
 - 3 Fabric or leather color number for upholstery insert, if selected
 - 4 Paint color number for base and frame:
 - 4016 White
 - 4017 Black
 - 4216 Red
 - 4217 Brown
 - 4218 Platinum Silver
 - 5 Options, if selected (see below)
- ▶ See *Coalesse Surface Materials Reference Guide*.

Options	U.S. Price	Required to Specify
---------	------------	---------------------

Surface Materials	Acrylic backer • Backer for chair with upholstered insert	+\$6	Specify with acrylic backer. ▶ See <i>Coalesse Surface Materials Reference Guide</i> .
Related Products	• Café and conference tables		▶ Page 334

Specification Information

Style Number	U.S. Base Prices														Leather Grades:			Polypropylene
	COM	6	7	8	9	10	11	12	13	14	COL	C	E					

Sled Base Counter-Height Stool with No Insert

COEL500	\$481	N.A.	N.A.	N.A.	N.A.	N.A.	N.A.	N.A.	N.A.	N.A.	N.A.	N.A.	N.A.	N.A.	N.A.
---------	-------	------	------	------	------	------	------	------	------	------	------	------	------	------	------



Overall: 18"D 18¼"W 34½"H
 Seat: 26¼"H

Sled Base Counter-Height Stool with Polypropylene Insert

COEL500INSERT	N.A.	N.A.	N.A.	N.A.	N.A.	N.A.	N.A.	N.A.	N.A.	N.A.	N.A.	N.A.	N.A.	N.A.	\$509
---------------	------	------	------	------	------	------	------	------	------	------	------	------	------	------	-------

▶ Specification Information, continued on next page



Overall: 18"D 18¼"W 34½"H
 Seat: 26¼"H



For Canadian Pricing
 Multiply U.S. Price by the Canadian price factor.
 ▶ See page 1 for details.

Enea Lottus Sled Base Stools

DESIGN LIEVORE ALTHERR MOLINA DESIGN ORIGIN: SPAIN

► Specification Information, continued from previous page

Specification Information

Style Number	U.S. Base Prices														Leather Grades:			Polypropylene
	Fabric Grades:														COL	C	E	
	COM	6	7	8	9	10	11	12	13	14								

Sled Base Counter-Height Stool with Upholstered Insert

COEL500UPH	\$633	\$614	\$625	\$634	\$653	\$669	\$680	\$687	\$720	\$766	\$849	\$860	\$889	N.A.
------------	-------	-------	-------	-------	-------	-------	-------	-------	-------	-------	-------	-------	-------	------

COM/yds = ¾, COL/sq ft = 15



Overall: 18"D 18¼"W 34½"H
Seat: 26¼"H

Sled Base Bar-Height Stool with No Insert

COEL400	\$530	N.A.	N.A.	N.A.	N.A.	N.A.	N.A.	N.A.	N.A.	N.A.	N.A.	N.A.	N.A.	N.A.
---------	-------	------	------	------	------	------	------	------	------	------	------	------	------	------



Overall: 18"D 18¼"W 38½"H
Seat: 30"H

Sled Base Bar-Height Stool with Polypropylene Insert

COEL400INSERT	N.A.	N.A.	N.A.	N.A.	N.A.	N.A.	N.A.	N.A.	N.A.	N.A.	N.A.	N.A.	N.A.	\$558
---------------	------	------	------	------	------	------	------	------	------	------	------	------	------	-------



Overall: 18"D 18¼"W 38½"H
Seat: 30"H

Sled Base Bar-Height Stool with Upholstered Insert

COEL400UPH	\$682	\$663	\$674	\$683	\$702	\$718	\$729	\$736	\$769	\$815	\$898	\$909	\$938	N.A.
------------	-------	-------	-------	-------	-------	-------	-------	-------	-------	-------	-------	-------	-------	------

COM/yds = ¾, COL/sq ft = 15



Overall: 18"D 18¼"W 38½"H
Seat: 30"H

Guest/ Side/ Stack Seating



For Canadian Pricing
Multiply U.S. Price by the Canadian price factor.
► See page 1 for details.

Enea Lottus Post Base Stools

DESIGN LIEVORE ALTHERR MOLINA DESIGN ORIGIN: SPAIN

Tip: Post stool seat swivels.

Tip: For Customer's Own Material or Leather, see necessary requirements, important processing instructions, and ordering information

► See *Coalesse Surface Materials Reference Guide*.

Tip: CAL133 for polypropylene and fire code seating are available as a special quote. Polypropylene color will change slightly when FR treatment is applied. Contact customer service for availability and pricing. Minimum quantity will apply.

Standard Includes	Required to Specify
-------------------	---------------------

- Base and frame constructed of steel tubing
- Seat and back: polypropylene
- Insert, if selected: Polypropylene or upholstery

- 1 Style number
 - 2 Plastic color number for seat and back:
 - 003 White
 - 0013 Sunset Orange
 - 0014 Clover Green
 - 0015 Sand
 - 0016 Walnut Brown
 - 0017 Cool Grey
 - 0414 Anthracite Grey
 - 0421 Blue
 - 400 Black
 - 409 Red
 - 3 Fabric or leather color number for upholstery insert, if selected
 - 4 Paint color number for base and frame:
 - 4016 White
 - 4017 Black
 - 4216 Red
 - 4217 Brown
 - 4218 Platinum Silver
 - 5 Options, if selected (see below)
- See *Coalesse Surface Materials Reference Guide*.

Options	U.S. Price	Required to Specify
---------	------------	---------------------

Surface Materials	Acrylic backer <ul style="list-style-type: none"> • Backer for chair with upholstered insert 	+\$ 6 Specify with acrylic backer. ► See <i>Coalesse Surface Materials Reference Guide</i> .
	<ul style="list-style-type: none"> • Polished trivalent chrome ring 	+\$56 Specify with trivalent chrome ring.

Related Products • Café and conference tables ► Page 334

Specification Information

Style Number	U.S. Base Prices														Leather Grades:		Polypropylene
	Fabric Grades:	6	7	8	9	10	11	12	13	14	COL	C	E				

Post Base Counter-Height Stool with No Insert

COEL700	\$930	N.A.	N.A.	N.A.	N.A.	N.A.	N.A.	N.A.	N.A.	N.A.	N.A.	N.A.	N.A.	N.A.	N.A.
---------	-------	------	------	------	------	------	------	------	------	------	------	------	------	------	------

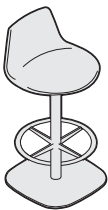

Overall: 19¾"D 19¾"W 34½"H
Seat: 26¼"H

Post Base Counter-Height Stool with Polypropylene Insert

COEL700INSERT	N.A.	N.A.	N.A.	N.A.	N.A.	N.A.	N.A.	N.A.	N.A.	N.A.	N.A.	N.A.	N.A.	N.A.	N.A.	\$957
---------------	------	------	------	------	------	------	------	------	------	------	------	------	------	------	------	-------

► Specification Information, continued on next page

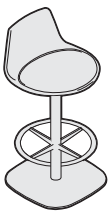

Overall: 19¾"D 19¾"W 34½"H
Seat: 26¼"H

Enea Lottus Post Base Stools

DESIGN LIEVORE ALTHERR MOLINA DESIGN ORIGIN: SPAIN

► Specification Information, continued from previous page

Specification Information

Style Number	U.S. Base Prices											Leather Grades:		Polypropylene
	Fabric Grades:											C	E	
	COM	6	7	8	9	10	11	12	13	14	COL			

Post Base Counter-Height Stool with Upholstered Insert

COEL700UPH	\$1082	\$1063	\$1074	\$1083	\$1102	\$1118	\$1129	\$1136	\$1169	\$1215	\$1298	\$1309	\$1338	N.A.
COM/yds = ¾, COL/sq ft = 15														

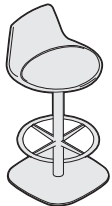

Overall: 19¾"D 19¾"W 34½"H
Seat: 26¼"H

Post Base Bar-Height Stool with No Insert

COEL600	\$ 941	N.A.	N.A.	N.A.	N.A.	N.A.	N.A.	N.A.	N.A.	N.A.	N.A.	N.A.	N.A.	N.A.
---------	--------	------	------	------	------	------	------	------	------	------	------	------	------	------

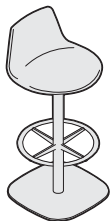

Overall: 19¾"D 19¾"W 38½"H
Seat: 30"H

Post Base Bar-Height Stool with Polypropylene Insert

COEL600INSERT	N.A.	N.A.	N.A.	N.A.	N.A.	N.A.	N.A.	N.A.	N.A.	N.A.	N.A.	N.A.	N.A.	\$969
---------------	------	------	------	------	------	------	------	------	------	------	------	------	------	-------

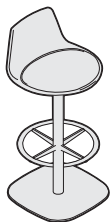

Overall: 19¾"D 19¾"W 38½"H
Seat: 30"H

Post Base Bar-Height Stool with Upholstered Insert

COEL600UPH	\$1093	\$1074	\$1085	\$1094	\$1113	\$1129	\$1140	\$1147	\$1180	\$1226	\$1309	\$1320	\$1349	N.A.
COM/yds = ¾, COL/sq ft = 15														

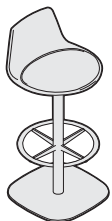

Overall: 19¾"D 19¾"W 38½"H
Seat: 30"H

Guest/Slider/Stack Seating



For Canadian Pricing
Multiply U.S. Price by the Canadian price factor.
► See page 1 for details.

Kart Nesting Chairs

DESIGN 5D STUDIO

 = Available in Rapid10.

Tip: COM must be approved for use. Call Customer Service at 1.800.627.6770.

Tip: Fabrics and leathers will appear loose with comfort wrinkles when upholstered.

Tip: For Customer's Own Material or Leather, see necessary requirements, important processing instructions, and ordering information
 ▶ See *Coalesse Surface Materials Reference Guide*.

Standard Includes	Required to Specify
<ul style="list-style-type: none"> • Four-prong Kart nesting base with nylon base tooth: die-cast aluminum with powder coat • Rub strips: injection-molded black polypropylene • Yoke strips: injection-molded black polypropylene • Hard, dual-wheel casters for use on carpet: black plastic • Seat and back: black or gray textured contoured, injection-molded glass-filled Polyurethane • Upholstered seat or upholstered seat and back, if selected: molded urethane foam over injection-molded polypropylene inner shell(s) • Folding seat with self-aligning features • Back supports: one-piece die-cast aluminum • Arms, if selected: die-cast aluminum support bar with black, molded, self-skinning polyurethane arm cap • Pneumatic height adjustment • Tilt tension adjustment • Zero front rise • Forward back lock 	<ol style="list-style-type: none"> 1 Style number 2 Powder coat color number for base 3 Color number for seat and back: <ul style="list-style-type: none"> - 6052 Milk - 6248 Midnight Brown - 6400 Black - 6427 Grey 4 Fabric or leather color number for upholstery 5 Options, if selected (see below) ▶ See <i>Coalesse Surface Materials Reference Guide</i> .

	Options	U.S. Price	Required to Specify
Surface Materials	Fire code seating <ul style="list-style-type: none"> • CAL 133 	+\$113	Specify with <i>CAL 133</i> . ▶ See <i>Coalesse Surface Materials Reference Guide</i> .
	Acrylic backer <ul style="list-style-type: none"> • Backer 	+\$ 8	Specify with <i>acrylic backer</i> . ▶ See <i>Coalesse Surface Materials Reference Guide</i> .
Casters	<ul style="list-style-type: none"> • Soft, dual-wheel casters for use on hard floors 	+\$ 36	Specify with <i>soft casters</i> .
Extra Foam	<ul style="list-style-type: none"> • Extra foam 	+\$ 62	Specify with <i>extra foam</i> .
Bell Glide	<ul style="list-style-type: none"> • Bell glide 	+\$ 31	Specify with <i>bell glide</i> .
Related Products	<ul style="list-style-type: none"> • Jury base • Pouch and leash 		▶ Page 274 ▶ Page 267

Specification Information

Style Number	U.S. Base Price
--------------	-----------------

Non-Upholstered with Arms

 126101	\$766
--	-------



Overall: 22½"D 24½"W 32½"-38"H
 Seat: 17¾"D 19"W 16"-21"H
 Arm: 25"-30½"H

Non-Upholstered without Arms

 126100	\$699
--	-------

▶ Specification Information, continued on next page



Kart Nesting Chairs

DESIGN 5D STUDIO

 = Available in Rapid10.

► Specification Information, continued from previous page

Specification Information

Style Number	U.S. Base Prices											Leather Grades:		
	Fabric Grades:											COL	C	E
	COM	6	7	8	9	10	11	12	13	14				



Upholstered Seat with Arms

 126201S	\$ 967	\$ 957	\$ 974	\$ 995	\$1020	\$1042	\$1066	\$1088	\$1094	\$1152	\$1025	\$1299	\$1381
COM/yds = 1, COL/sq ft = 12													

Upholstered Seat and Back with Arms

 126201	\$1015	\$1008	\$1022	\$1043	\$1068	\$1090	\$1114	\$1136	\$1142	\$1200	\$1078	\$1465	\$1572
COM/yds = 1, COL/sq ft = 19													



Upholstered Seat without Arms

 126200S	\$ 895	\$ 885	\$ 902	\$ 923	\$ 948	\$ 970	\$ 994	\$1016	\$1022	\$1080	\$ 951	\$1227	\$1309
COM/yds = 1, COL/sq ft = 12													

Upholstered Seat and Back without Arms

 126200	\$ 943	\$ 934	\$ 950	\$ 971	\$ 996	\$1018	\$1042	\$1064	\$1070	\$1128	\$1004	\$1264	\$1343
COM/yds = 1, COL/sq ft = 19													

Pouch and Leash for Use on Nesting Chairs



Standard Includes

- Leash to retain up to 10 nested chairs
- Pouch to store leash
- Pouch attaches to bottom of seat

Required to Specify

Style number

Specification Information

Style Number	U.S. Price
--------------	------------

 126900	\$62
--	------



For Canadian Pricing
Multiply U.S. Price by the Canadian price factor.
► See page 1 for details.

Kart Stools on Casters

DESIGN 5D STUDIO

 = Available in Rapid10.

Tip: COM must be approved for use. Call Customer Service at 1.800.627.6770.

Tip: Stools do not nest.

Tip: Fabrics and leathers will appear loose with comfort wrinkles when upholstered.

Tip: For Customer's Own Material or Leather, see necessary requirements, important processing instructions, and ordering information
 ► See *Coalesse Surface Materials Reference Guide*.

Standard Includes	Required to Specify
<ul style="list-style-type: none"> • Five-prong base with 25" span: one-piece die-cast aluminum with powder coat color • Telescoping hub cover: black plastic • Adjustable 19" diameter chrome foot ring • Hard, dual-wheel casters for use on carpet: black • Seat and back: black or gray textured contoured, injection-molded glass-filled polypropylene • Upholstered seat or upholstered seat and back, if selected: molded urethane foam over injection-molded polypropylene inner shell(s) • Back supports: one-piece die-cast aluminum • Arms, if selected: die-cast aluminum support bar with black, molded, self-skinning polyurethane arm cap • Pneumatic height adjustment • Tilt tension adjustment • Zero front rise • Forward back lock 	<ol style="list-style-type: none"> 1 Style number 2 Powder coat color number for base 3 Color number for seat and back: <ul style="list-style-type: none"> - 6052 Milk - 6248 Midnight Brown - 6400 Black - 6427 Grey 4 Fabric or leather color number for upholstery 5 Options, if selected (see below) ► See <i>Coalesse Surface Materials Reference Guide</i> .

Options	U.S. Price	Required to Specify
Surface Materials <ul style="list-style-type: none"> • Fire code seating • CAL 133 	+\$113	Specify with <i>CAL 133</i> . ► See <i>Coalesse Surface Materials Reference Guide</i> .
<ul style="list-style-type: none"> • Acrylic backer • Backer 	+\$ 8	Specify with <i>acrylic backer</i> . ► See <i>Coalesse Surface Materials Reference Guide</i> .
Casters <ul style="list-style-type: none"> • Soft, dual-wheel casters for use on hard floors 	+\$ 36	Specify with <i>soft casters</i> .
Extra Foam <ul style="list-style-type: none"> • Extra foam 	+\$ 62	Specify with <i>extra foam</i> .
Bell Glide <ul style="list-style-type: none"> • Bell glide 	+\$ 31	Specify with <i>bell glide</i> .

Specification Information

Style Number	U.S. Base Price
--------------	-----------------

Non-Upholstered with Arms

 126101ST	\$905
--	-------



Overall: 22½"D 24½"W 36½"-44"H
 Seat: 17¾"D 19"W 21"-28½"H
 Arm: 30½"-38"H
 Foot Ring: 8¼"-15½"

Non-Upholstered without Arms

 126100ST	\$836
--	-------

► Specification Information, continued on next page



For Canadian Pricing
 Multiply U.S. Price by the Canadian price factor.
 ► See page 1 for details.

Kart Stools on Casters

DESIGN 5D STUDIO

 = Available in Rapid10.

► Specification Information, continued from previous page

Specification Information

Style Number	U.S. Base Prices													
	Fabric Grades:											Leather Grades:		
	COM	6	7	8	9	10	11	12	13	14	COL	C	E	

Upholstered Seat with Arms

 126201SST	\$1105	\$1100	\$1112	\$1133	\$1158	\$1180	\$1204	\$1226	\$1232	\$1290	\$1170	\$1437	\$1519
COM/yds = 1, COL/sq ft = 12													

Upholstered Seat and Back with Arms

 126201ST	\$1153	\$1149	\$1160	\$1181	\$1206	\$1228	\$1252	\$1274	\$1280	\$1338	\$1220	\$1603	\$1710
COM/yds = 1, COL/sq ft = 19													

Upholstered Seat without Arms

 126200SST	\$1035	\$1028	\$1042	\$1063	\$1088	\$1110	\$1134	\$1156	\$1162	\$1220	\$1097	\$1367	\$1449
COM/yds = 1, COL/sq ft = 12													

Upholstered Seat and Back without Arms

 126200ST	\$1085	\$1080	\$1092	\$1113	\$1138	\$1160	\$1184	\$1206	\$1212	\$1270	\$1150	\$1535	\$1642
COM/yds = 1, COL/sq ft = 19													



For Canadian Pricing
 Multiply U.S. Price by the
 Canadian price factor.
 ► See page 1 for details.

Kart Café Four-Leg Stools with Arms

DESIGN 5D STUDIO

 = Available in Rapid10.



Overall: 25"D 22⁹/₂₅"W 46"H
 Seat: 18¹/₄"D 19⁷/₁₀"W 30"H
 Arm: 38⁴/₂₅"H
 Foot Rest: 13¹/₄" from floor

Tip: COM must be approved for use. Call Customer Service at 1.800.627.6770.

Tip: Chairs do not stack.

Tip: Fabrics and leathers will appear loose with comfort wrinkles when upholstered.

Tip: For Customer's Own Material or Leather, see necessary requirements, important processing instructions, and ordering information
 ▶ See *Coalesse Surface Materials Reference Guide*.

Tip: Arms, glides, and back-seat connection will always be black.

Standard Includes

- Frame: 16-gauge tubular steel with powder coat color
- Flex bars: two black resilient polypropylene flexible connectors in the back frame allow the back to tilt back approximately eight degrees for added comfort
- Glides: non-marring, black polypropylene
- Seat and back: black textured contoured, injection-molded glass-filled, high-impact polypropylene
- Upholstered seat or upholstered seat and back, if selected: resilient, flame-retardant, molded urethane foam over injection-molded polypropylene inner shell(s)

Required to Specify

- 1 Style number
 - 2 Powder coat color number for base
 - 3 Color number for seat and back:
 - 6052 Milk
 - 6248 Midnight Brown
 - 6400 Black
 - 4 Fabric or leather color number for upholstery
 - 5 Options, if selected (see below)
- ▶ See *Coalesse Surface Materials Reference Guide*.

Options

Surface Materials	Options	U.S. Price	Required to Specify
	Fire code seating		
	• CAL 133	+\$ 113	Specify with CAL 133. ▶ See <i>Coalesse Surface Materials Reference Guide</i> .
	Acrylic backer		
	• Backer	+\$ 8	Specify with acrylic backer. ▶ See <i>Coalesse Surface Materials Reference Guide</i> .

Specification Information

Style Number	U.S. Price
126111ST	\$526

Non-Upholstered

126111ST	\$526
----------	-------

Specification Information

Style Number	U.S. Base Prices														Leather Grades:		
	Fabric Grades:														COL	C	E
	COM	6	7	8	9	10	11	12	13	14							
126211SST	\$751	\$734	\$761	\$785	\$810	\$830	\$855	\$878	\$884	\$ 945	\$804	\$1104	\$1189				

Upholstered Seat

126211SST	\$751	\$734	\$761	\$785	\$810	\$830	\$855	\$878	\$884	\$ 945	\$804	\$1104	\$1189
-----------	-------	-------	-------	-------	-------	-------	-------	-------	-------	--------	-------	--------	--------

COM/yds = 1, COL/sq ft = 12

Upholstered Seat and Back

126211ST	\$831	\$817	\$841	\$865	\$890	\$910	\$935	\$958	\$964	\$1025	\$887	\$1308	\$1421
----------	-------	-------	-------	-------	-------	-------	-------	-------	-------	--------	-------	--------	--------

COM/yds = 1, COL/sq ft = 19



For Canadian Pricing
 Multiply U.S. Price by the Canadian price factor.
 ▶ See page 1 for details.

Kart Stack Stacking Chairs with Arms

DESIGN 5D STUDIO

 = Available in Rapid10.

Tip: COM must be approved for use. Call Customer Service at 1.800.627.6770.

Tip: Chairs stack six high on the floor.

Tip: Fabrics and leathers will appear loose with comfort wrinkles when upholstered.

Tip: For Customer's Own Material or Leather, see necessary requirements, important processing instructions, and ordering information
 ▶ See *Coalesse Surface Materials Reference Guide*.

Tip: Arms, glides, and back-seat connection will always be black.

Standard Includes	Required to Specify
-------------------	---------------------

<ul style="list-style-type: none"> Frame: 16-gauge tubular steel with powder coat color Flex bars: two black resilient polypropylene flexible connectors in the back frame allow the back to tilt back approximately eight degrees for added comfort Glides: non-marring, black polypropylene Seat and back: black textured contoured, injection-molded glass-filled, high-impact polypropylene Upholstered seat or upholstered seat and back, if selected: resilient, flame-retardant, molded urethane foam over injection-molded polypropylene inner shell(s) 	<ol style="list-style-type: none"> 1 Style number 2 Powder coat color number for base 3 Color number for seat and back: <ul style="list-style-type: none"> - 6052 Milk - 6248 Midnight Brown - 6400 Black 4 Fabric or leather color number for upholstery 5 Options, if selected (see below) <p>▶ See <i>Coalesse Surface Materials Reference Guide</i>.</p>
--	---

Options	U.S. Price	Required to Specify
---------	------------	---------------------

Surface Materials <ul style="list-style-type: none"> Fire code seating CAL 133 <hr/> <ul style="list-style-type: none"> Acrylic backer Backer 	+\$ 113 No cost	Specify with <i>CAL 133</i> . ▶ See <i>Coalesse Surface Materials Reference Guide</i> . Add suffix C to the style number. ▶ Page 272
Related Products <ul style="list-style-type: none"> Dolly 		

Specification Information

Style Number	U.S. Price
--------------	------------

Non-Upholstered

 126111	\$397
--	-------

Specification Information

Style Number	U.S. Base Prices										Leather Grades:		
	Fabric Grades:										COL	C	E
	COM	6	7	8	9	10	11	12	13	14			

Upholstered Seat

 126211S	\$652	\$633	\$665	\$691	\$718	\$743	\$767	\$793	\$801	\$865	\$705	\$1034	\$1126
COM/yds = 1, COL/sq ft = 12													

Upholstered Seat and Back

 126211	\$737	\$721	\$750	\$776	\$803	\$828	\$852	\$878	\$886	\$950	\$792	\$1253	\$1375
COM/yds = 1, COL/sq ft = 19													



Overall: 22¾"D 22¼"W 32⅞"H
 Seat: 18¼"D 19¾"W 17⅞"H
 Arm: 26"H

For Canadian Pricing
 Multiply U.S. Price by the Canadian price factor.
 ▶ See page 1 for details.

Kart Stack Accessory

DESIGN 5D STUDIO

Dolly

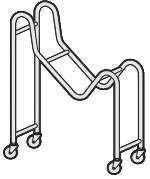

Tip: Holds 10 chairs (40"D x 25"W x 63"H non-upholstered or 68"H upholstered).

Standard Includes	Required to Specify
-------------------	---------------------

- 35"D x 14 1/2"W x 42 1/2"H four-wheel dolly: black

Style number

Specification Information	
---------------------------	--

Style Number	U.S. Price
793390	\$429



For Canadian Pricing
 Multiply U.S. Price by the
 Canadian price factor.
 ▶ See page 1 for details.

Coalesse

Kart Stack *Accessory*

DESIGN 5D STUDIO

Kart Jury Bases

Tip: Standard seat height range: 16 1/2"-20 1/2"H.

Tip: Tall seat height range: 19 1/4"-23 1/4"H.

Tip: Kart seat folds up.

Tip: COM must be approved for use. Call Customer Service at 1.800.627.6770.

Tip: Fabrics and leathers will appear loose with comfort wrinkles when upholstered.

Tip: For Customer's Own Material or Leather, see necessary requirements, important processing instructions, and ordering information
 ► See *Coalesse Surface Materials Reference Guide*.

Tip: Jury bases are standard with pneumatic swivel-tilt return mechanism.



Standard Includes	Required to Specify
-------------------	---------------------

- | | |
|---|--|
| <ul style="list-style-type: none"> • Pneumatic height adjustment • Jury base with memory return and 180 degree swivel • Standard jury base, if selected, is made up of 2 1/2" diameter column and 8" base plate: 4134 black only • Tall jury base, if selected, is made up of 2 1/2" diameter column and 8" base plate: 4134 black only • Hardware for floor attachment not included | 1 Style number
2 Options, if selected (see below) |
|---|--|

Options	U.S. Price	Required to Specify
---------	------------	---------------------

Surface Materials Fire code seating • CAL 133 (Upholstered seat and back only) Acrylic backer • Backer	+\$ 113 +\$ 8	Specify with <i>CAL 133</i> . ► See <i>Coalesse Surface Materials Reference Guide</i> . Specify with <i>acrylic backer</i> . ► See <i>Coalesse Surface Materials Reference Guide</i> .
Extra Foam	• Extra foam	+\$ 62 Specify with <i>extra foam</i> .
Related Products	• Kart	► Page 266

Specification Information													
---------------------------	--	--	--	--	--	--	--	--	--	--	--	--	--

Style Number	U.S. Base Prices												Leather Grades:	
	Fabric Grades:												COL	C
	COM	6	7	8	9	10	11	12	13	14				

Kart with Arms-Standard

127101J	\$ 989	N.A.	N.A.	N.A.	N.A.	N.A.	N.A.	N.A.	N.A.	N.A.	N.A.	N.A.	N.A.
127201SJ	\$1190	\$1186	\$1197	\$1218	\$1243	\$1265	\$1289	\$1311	\$1317	\$1375	\$1257	\$1522	\$1604
127201J	\$1238	\$1236	\$1245	\$1266	\$1291	\$1313	\$1337	\$1359	\$1365	\$1423	\$1306	\$1688	\$1795

Kart Armless-Standard

127100J	\$ 922	N.A.	N.A.	N.A.	N.A.	N.A.	N.A.	N.A.	N.A.	N.A.	N.A.	N.A.	N.A.
127200SJ	\$1118	\$1113	\$1125	\$1146	\$1171	\$1193	\$1217	\$1239	\$1245	\$1303	\$1182	\$1450	\$1532
127200J	\$1166	\$1162	\$1173	\$1194	\$1219	\$1241	\$1265	\$1287	\$1293	\$1351	\$1232	\$1487	\$1566

► Specification Information, continued on next page



For Canadian Pricing
 Multiply U.S. Price by the Canadian price factor.
 ► See page 1 for details.

Kart Jury Bases

► Specification Information, continued from previous page

Specification Information

Style Number	U.S. Base Prices												
	Fabric Grades:											Leather Grades:	
	COM	6	7	8	9	10	11	12	13	14	COL	C	E



Kart with Arms-Tall

128101J	\$ 989	N.A.	N.A.	N.A.	N.A.	N.A.	N.A.	N.A.	N.A.	N.A.	N.A.	N.A.	N.A.
128201SJ	\$1190	\$1186	\$1197	\$1218	\$1243	\$1265	\$1289	\$1311	\$1317	\$1375	\$1257	\$1522	\$1604
128201J	\$1238	\$1236	\$1245	\$1266	\$1291	\$1313	\$1337	\$1359	\$1365	\$1423	\$1306	\$1688	\$1795



Kart with Armless-Tall

128100J	\$ 922	N.A.	N.A.	N.A.	N.A.	N.A.	N.A.	N.A.	N.A.	N.A.	N.A.	N.A.	N.A.
128200SJ	\$1118	\$1113	\$1125	\$1146	\$1171	\$1193	\$1217	\$1239	\$1245	\$1303	\$1182	\$1450	\$1532
128200J	\$1166	\$1162	\$1173	\$1194	\$1219	\$1241	\$1265	\$1287	\$1293	\$1351	\$1232	\$1487	\$1566

Guest/ Side/ Stack Seating



For Canadian Pricing
 Multiply U.S. Price by the
 Canadian price factor.
 ► See page 1 for details.

Kathryn

DESIGN STUDIO B DESIGN ORIGIN: UNITED STATES

Tip: Fabrics and leathers will appear loose with comfort wrinkles when upholstered.

Tip: Recommended leathers are Elmosoft Grade C and Elmorustical Grade E.

Tip: Special color match, consult Customer Service.

Tip: For Customer's Own Material or Leather, see necessary requirements, important processing instructions, and ordering information
 ▶ See *Coalesse Surface Materials Reference Guide*.

Standard Includes	Required to Specify
-------------------	---------------------

- | | |
|--|--|
| <ul style="list-style-type: none"> • Frame: European beech hardwood • Mortise and tenon joinery • Upholstery: Multiple densities of laminated polyurethane foam and polyester fiber • Glides: non-adjustable | <ol style="list-style-type: none"> 1 Style number 2 Number of fabrics if contrasting fabric style number is selected 3 Fabric or leather color number for upholstery 4 Wood color number for frame <p>▶ See <i>Coalesse Surface Materials Reference Guide</i>.
 5 Options, if selected (see below)
 ▶ See <i>Coalesse Surface Materials Reference Guide</i>.</p> |
|--|--|

Options	U.S. Price	Required to Specify
---------	------------	---------------------

Surface Materials	<ul style="list-style-type: none"> • Contrasting fabric +\$ 113 per fabric • Contrasting welt +\$125 	Add suffix K to the style number and select fabric color number. Specify with <i>contrasting welt</i> and select fabric color number.
Fire code seating	<ul style="list-style-type: none"> • CAL 133 +\$113 	Specify with <i>CAL 133</i> . ▶ See <i>Coalesse Surface Materials Reference Guide</i> .
Acrylic backer	<ul style="list-style-type: none"> • Backer for chair with open back +\$ 8 • Backer for chair with upholstery +\$ 12 	Specify with <i>acrylic backer</i> . Specify with <i>acrylic backer</i> . ▶ See <i>Coalesse Surface Materials Reference Guide</i> .

Specification Information

Style Number	U.S. Base Prices														Leather Grades:		
	Fabric Grades:														COL	C	E
	COM	6	7	8	9	10	11	12	13	14							

Wood with Open Back

2540-1	\$853	\$846	\$857	\$863	\$874	\$886	\$ 922	\$ 947	\$ 981	\$1047	\$1088	\$1372	\$1436
--------	-------	-------	-------	-------	-------	-------	--------	--------	--------	--------	--------	--------	--------

COM/yds = 1, COL/sq ft = 18

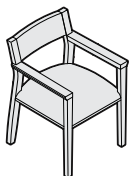

Overall: 22³/₄"D 22³/₂₀"W 32"H
 Inside: 19"D 18¹/₂"W 14"H
 Seat: 18"H
 Arm: 26"H

Wood/Upholstered with Panel Back

2542-1	\$883	\$893	\$904	\$916	\$934	\$952	\$1005	\$1063	\$1088	\$1144	\$1118	\$1560	\$1661
--------	-------	-------	-------	-------	-------	-------	--------	--------	--------	--------	--------	--------	--------

COM/yds = 1¹/₂, COL/sq ft = 27

▶ Specification Information, continued on next page

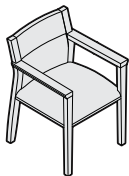

Overall: 22³/₄"D 22³/₂₀"W 32"H
 Inside: 19"D 18¹/₂"W 14"H
 Seat: 18"H
 Arm: 26"H



For Canadian Pricing
 Multiply U.S. Price by the Canadian price factor.
 ▶ See page 1 for details.

Kathryn

DESIGN STUDIO B DESIGN ORIGIN: UNITED STATES

► Specification Information, continued from previous page

Specification Information

Style Number	U.S. Base Prices											Leather Grades:		
	Fabric Grades:											COL	C	E
	COM	6	7	8	9	10	11	12	13	14				

Fully Upholstered Back

2547-1	\$ 996	\$1006	\$1022	\$1029	\$1047	\$1065	\$1118	\$1153	\$1208	\$1271	\$1231	\$1673	\$1774
--------	--------	--------	--------	--------	--------	--------	--------	--------	--------	--------	--------	--------	--------

COM/yds = 1½, COL/sq ft = 27

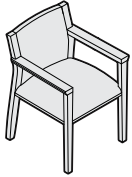

Overall: 22¾"D 22¾"W 32"H
 Inside: 19"D 18½"W 14"H
 Seat: 18"H
 Arm: 26"H

Fully Upholstered Back with Ribbed Upholstery

2547-1RIBD	\$1028	\$1038	\$1054	\$1061	\$1079	\$1097	\$1150	\$1185	\$1240	\$1303	\$1263	\$1705	\$1806
------------	--------	--------	--------	--------	--------	--------	--------	--------	--------	--------	--------	--------	--------



Guest/Side/Stack Seating



For Canadian Pricing
 Multiply U.S. Price by the
 Canadian price factor.
 ► See page 1 for details.

Last Minute Stool by Viccarbe

DESIGN PATRICIA URQUILOA DESIGN ORIGIN: 2003 SPAIN

Tip: Fabrics and leathers will appear loose with comfort wrinkles when upholstered.

Tip: For Customer's Own Material or Leather, see necessary requirements, important processing instructions, and ordering information
 ► See *Coalesse Surface Materials Reference Guide*.

Standard Includes	Required to Specify
-------------------	---------------------

- | | |
|---|--|
| <ul style="list-style-type: none"> Upholstery for stool: fabric or leather Frame: polished trivalent chrome | 1 Style number
2 Fabric or leather color number for upholstery
3 Options, if selected (see below)
► See <i>Coalesse Surface Materials Reference Guide</i> . |
|---|--|

Options	U.S. Price	Required to Specify
---------	------------	---------------------

Surface Materials <ul style="list-style-type: none"> Fire code seating <ul style="list-style-type: none"> CAL 133 	+\$218	Specify with CAL 133. ► See <i>Coalesse Surface Materials Reference Guide</i> .
<ul style="list-style-type: none"> Acrylic backer <ul style="list-style-type: none"> Backer 	+\$ 6	Specify with acrylic backer. ► See <i>Coalesse Surface Materials Reference Guide</i> .

Specification Information													
---------------------------	--	--	--	--	--	--	--	--	--	--	--	--	--

Style Number	U.S. Base Prices												Leather Grades:		
	Fabric Grades:												COL	C	E
	COM	6	7	8	9	10	11	12	13	14					

Medium Stool

COLMS25	\$ 995	\$ 976	\$ 984	\$ 989	\$ 999	\$1006	\$1030	\$1047	\$1081	\$1126	\$1211	\$1477	\$1530
---------	--------	--------	--------	--------	--------	--------	--------	--------	--------	--------	--------	--------	--------

COM/yds = ¾, COL/sq ft = 17

High Stool

COLMS30	\$1039	\$1020	\$1028	\$1033	\$1043	\$1050	\$1074	\$1091	\$1125	\$1170	\$1255	\$1521	\$1574
---------	--------	--------	--------	--------	--------	--------	--------	--------	--------	--------	--------	--------	--------

COM/yds = ¾, COL/sq ft = 17



Overall: 17"D 17¼"W 26½"H
 Seat: 25½"H



Overall: 17"D 17¼"W 31½"H
 Seat: 30½"H



For Canadian Pricing
 Multiply U.S. Price by the Canadian price factor.
 ► See page 1 for details.

Lox Chairs

DESIGN PEARSONLLOYD DESIGN ORIGIN: ENGLAND

Tip: For Customer's Own Material or Leather, see necessary requirements, important processing instructions, and ordering information
 ▶ See *Coalesse Surface Materials Reference Guide*.

Tip: Due to the design and construction techniques of the Lox chairs only certain textiles can be successfully applied, therefore all COM fabrics must be submitted to Coalesse for approval prior to order acceptance.

Tip: Textile patterns for chair with upholstered back will require seams on the inside back of the chair. Limited solid textiles or leathers may also require seams. For specific textile information, visit the fabric database at www.coalesse.com.

Standard Includes

- Shell: plastic
- Base: 8046 Polished Aluminum
- Seat: fixed upholstery with polyurethane foam base
- Back: fixed upholstery with polyurethane foam base, if selected
- Swivel mechanism
- Glides: plastic

Required to Specify

- 1 Style number
 - 2 Plastic color number for shell:
6345 Black
6346 White
 - 3 Fabric or leather color number for upholstery
 - 4 Options, if selected (see below)
- ▶ See *Coalesse Surface Materials Reference Guide*.

Options

Surface Materials	Options	U.S. Price	Required to Specify
	Fire code seating		
	• CAL 133	+\$ 113	Specify with CAL 133. ▶ See <i>Coalesse Surface Materials Reference Guide</i> .
	Acrylic backer		
	• Backer for chair with upholstered seat	+\$ 6	Specify with acrylic backer. ▶ See <i>Coalesse Surface Materials Reference Guide</i> .
	• Backer for chair with upholstered seat and back	+\$ 10	Specify with acrylic backer.
Felt Glides	• Glides	No cost	Specify with felt glides.
Related Products	• Stools		▶ Page 280

Specification Information

Style Number	U.S. Base Prices												Leather Grades:				
	Fabric Grades:												COL	C	E		
COM	6	7	8	9	10	11	12	13	14	15	16	17	18	19	20	21	22

Chair with Upholstered Seat

COLX100	\$1098	\$1078	\$1089	\$1097	\$1116	\$1130	\$1141	\$1148	\$1179	\$1223	\$1314	\$1179	\$1302
---------	--------	--------	--------	--------	--------	--------	--------	--------	--------	--------	--------	--------	--------

COM/yds = 3/4, COL/sq ft = 13



Overall: 27"D 27"W 31"H
 Seat: 19"H 18"D

Chair with Upholstered Seat and Back

COLX110	\$1310	\$1303	\$1319	\$1333	\$1365	\$1390	\$1407	\$1418	\$1471	\$1544	\$1526	\$1642	\$1681
---------	--------	--------	--------	--------	--------	--------	--------	--------	--------	--------	--------	--------	--------

COM/yds = 1 1/4, COL/sq ft = 22



Overall: 27"D 27"W 32"H
 Seat: 19"H 18"D

 **For Canadian Pricing**
 Multiply U.S. Price by the Canadian price factor.
 ▶ See page 1 for details.

Lox Stools

DESIGN PEARSONLLOYD DESIGN ORIGIN: ENGLAND

Tip: Due to the design and construction techniques of the Lox stools only certain textiles can be successfully applied, therefore all COM fabrics must be submitted to Coalesse for approval prior to order acceptance.

Tip: For Customer's Own Material or Leather, see necessary requirements, important processing instructions, and ordering information
 ▶ See *Coalesse Surface Materials Reference Guide*.

Standard Includes		Required to Specify	
	<ul style="list-style-type: none"> • Shell: plastic • Base: 9251 Brushed Chrome • Seat: upholstered foam • Swivel mechanism • Height-adjustable button under seat • Felt glides 		1 Style number 2 Plastic color number for shell: 6347 Black Gloss 6348 White Gloss 3 Fabric or leather color number for upholstery 4 Options, if selected (see below) ▶ See <i>Coalesse Surface Materials Reference Guide</i> .
Options		U.S. Price	Required to Specify
Surface Materials	Fire code seating <ul style="list-style-type: none"> • CAL 133 	+\$113	Specify with CAL 133. ▶ See <i>Coalesse Surface Materials Reference Guide</i> .
	Acrylic backer <ul style="list-style-type: none"> • Backer 	+\$ 6	Specify with acrylic backer. ▶ See <i>Coalesse Surface Materials Reference Guide</i> .
Related Products	• Chairs		▶ Page 279

Specification Information													
Style Number	U.S. Base Prices												
	Fabric Grades:												
	COM	6	7	8	9	10	11	12	13	14	Leather Grades:		
											COL	C	E

Counter-Height Stool

COLX200	\$1204	\$1184	\$1195	\$1203	\$1222	\$1236	\$1247	\$1254	\$1285	\$1329	\$1420	\$1385	\$1408
---------	--------	--------	--------	--------	--------	--------	--------	--------	--------	--------	--------	--------	--------

COM/yds = ¾, COL/sq ft = 13

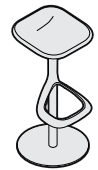

Overall: 17"D 17"W 28"-32"H
 Seat: 26"-30"H

Bar-Height Stool

COLX210	\$1257	\$1237	\$1248	\$1256	\$1275	\$1289	\$1300	\$1307	\$1338	\$1382	\$1473	\$1438	\$1461
---------	--------	--------	--------	--------	--------	--------	--------	--------	--------	--------	--------	--------	--------

COM/yds = ¾, COL/sq ft = 13

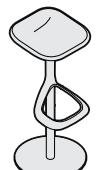

Overall: 17"D 17"W 31"-34"H
 Seat: 29"-33"H

For Canadian Pricing
 Multiply U.S. Price by the Canadian price factor.
 ▶ See page 1 for details.

Rocky Four-Star Nesting Chairs with Arms

DESIGN 5D STUDIO



Overall: 22¾"D 26"W 36"-41H
 Seat: 17¼"D 19½"W 16"-21"H
 Arms: 24½"-29½"H

Tip: COM must be approved for use. Call Customer Service at 1.800.627.6770.

Tip: Fabrics and leathers will appear loose with comfort wrinkles when upholstered.

Tip: For Customer's Own Material or Leather, see necessary requirements, important processing instructions, and ordering information
 ▶ See *Coalesse Surface Materials Reference Guide*.

Standard Includes	Required to Specify
<ul style="list-style-type: none"> • Four-prong Rocky nesting base: one piece, solid color glass-filled nylon in graphite only • Hip pivoting springs for lumbar support • Hard, dual-wheel casters for use on carpet: black plastic • Seat and back with molded-in arms: injection-molded solid color polypropylene with textured finish • Upholstered seat or upholstered seat and back, if selected: molded urethane foam over injection-molded polypropylene inner shell(s) • Folding seat with pneumatic self-aligning features • Pneumatic height adjustment • Zero front rise 	1 Style number 2 Color number for seat and back: - 6315 Graphite - 6316 White 3 Fabric or leather color number for upholstery 4 Options, if selected (see below) ▶ See <i>Coalesse Surface Materials Reference Guide</i> .

Options	U.S. Price	Required to Specify
Surface Materials <ul style="list-style-type: none"> • Fire code seating CAL 133 • Acrylic backer Backer 	+\$ 113 +\$ 7	Specify with CAL 133. ▶ See <i>Coalesse Surface Materials Reference Guide</i> . Specify with acrylic backer. ▶ See <i>Coalesse Surface Materials Reference Guide</i> .
Casters <ul style="list-style-type: none"> • Soft, dual-wheel casters 	+\$ 36 for use on hard floors	Specify with soft casters.

Specification Information	
Style Number	U.S. Base Price

Non-Upholstered

112101 \$631

Style Number	U.S. Base Prices											Leather Grades:			
	Fabric Grades:											COL	C	E	
COM	6	7	8	9	10	11	12	13	14	15	16	17	18	19	20

Upholstered Seat

112201S \$824 \$810 \$854 \$878 \$898 \$921 \$942 \$ 965 \$ 979 \$1007 \$904 \$1090 \$1157

COM/yds = .9, COL/sq ft = 10

Upholstered Seat and Back

112201 \$862 \$851 \$899 \$922 \$948 \$972 \$994 \$1020 \$1040 \$1071 \$946 \$1212 \$1298

COM/yds = .9, COL/sq ft = 14



For Canadian Pricing
 Multiply U.S. Price by the Canadian price factor.
 ▶ See page 1 for details.

Rocky Five-Star Base Chairs

DESIGN 5D STUDIO



Overall: 24½"D 26"W 36"-41"H
 Seat: 17¼"D 19½"W 16"-21"H
 Arms: 24½"-29½"H

Tip: COM must be approved for use. Call Customer Service at 1.800.627.6770.

Tip: Chairs do not nest.

Tip: Fabrics and leathers will appear loose with comfort wrinkles when upholstered.

Tip: For Customer's Own Material or Leather, see necessary requirements, important processing instructions, and ordering information
 ▶ See *Coalesse Surface Materials Reference Guide*.

Standard Includes	Required to Specify
<ul style="list-style-type: none"> • Five-prong base, 25" span: one-piece, solid color glass-filled nylon in black only • Hip pivoting springs for lumbar support • Hard, dual-wheel casters for use on carpet: black plastic • Seat and back with molded-in arms: injection-molded solid color polypropylene with textured finish • Upholstered seat or upholstered seat and back, if selected: molded urethane foam over injection-molded polypropylene inner shell(s) • Pneumatic height adjustment • Zero front rise 	1 Style number 2 Color number for seat and back: - 6315 Graphite - 6316 White 3 Fabric or leather color number for upholstery 4 Options, if selected (see below) ▶ See <i>Coalesse Surface Materials Reference Guide</i> .

	Options	U.S. Price	Required to Specify
Surface Materials	Fire code seating		
	• CAL 133	+\$ 113	Specify with CAL 133. ▶ See <i>Coalesse Surface Materials Reference Guide</i> .
	Acrylic backer		
	• Backer	+\$ 7	Specify with acrylic backer. ▶ See <i>Coalesse Surface Materials Reference Guide</i> .
Casters	• Soft, dual-wheel casters for use on hard floors	+\$ 36	Specify with soft casters.
Related Product	• Jury base		▶ Page 284

Specification Information	
Style Number	U.S. Base Price

Non-Upholstered

112301 \$607

Style Number	U.S. Base Prices										Leather Grades:		
	Fabric Grades:										COL	C	E
	COM	6	7	8	9	10	11	12	13	14			

Upholstered Seat

112401S \$798 \$783 \$828 \$849 \$872 \$895 \$916 \$939 \$953 \$ 981 \$877 \$1088 \$1162
 COM/yds = .9, COL/sq ft = 10

Upholstered Seat and Back

112401 \$837 \$823 \$867 \$888 \$911 \$934 \$955 \$978 \$992 \$1020 \$917 \$1187 \$1273
 COM/yds = .9, COL/sq ft = 14



For Canadian Pricing
 Multiply U.S. Price by the Canadian price factor.
 ▶ See page 1 for details.

Rocky Five-Star Base Stools

DESIGN 5D STUDIO



Overall: 24½"D 26"W 36½"-44H
 Seat: 17¼"D 19½"W 21"-28½"H
 Arms: 32-39½"H
 Footring: 10½"-15"H

Tip: COM must be approved for use. Call Customer Service at 1.800.627.6770.

Tip: Chairs do not nest.

Tip: Fabrics and leathers will appear loose with comfort wrinkles when upholstered.

Tip: For Customer's Own Material or Leather, see necessary requirements, important processing instructions, and ordering information
 ▶ See *Coalesse Surface Materials Reference Guide*.

Standard Includes	Required to Specify
<ul style="list-style-type: none"> • Five-prong base, 25" span: one-piece, solid color glass-filled nylon in black only • Adjustable 20" diameter chrome foot ring on die-cast aluminum hub • Hip pivoting springs for lumbar support • Hard, dual-wheel casters for use on carpet: black plastic • Seat and back with molded-in arms: injection-molded solid color polypropylene with textured finish • Upholstered seat or upholstered seat and back, if selected: molded urethane foam over injection-molded polypropylene inner shell(s) • Pneumatic height adjustment • Zero front rise 	1 Style number 2 Color number for seat and back: - 6315 Graphite - 6316 White 3 Fabric or leather color number for upholstery 4 Options, if selected (see below) ▶ See <i>Coalesse Surface Materials Reference Guide</i> .

Options	U.S. Price	Required to Specify
Surface Materials • Fire code seating • CAL 133	+\$ 113	Specify with CAL 133. ▶ See <i>Coalesse Surface Materials Reference Guide</i> .
• Acrylic backer • Backer	+\$ 7	Specify with acrylic backer. ▶ See <i>Coalesse Surface Materials Reference Guide</i> .
Casters • Soft, dual-wheel casters for use on hard floors	+\$ 36	Specify with soft casters.

Specification Information	
Style Number	U.S. Base Price
112301ST	\$760

Non-Upholstered

112301ST \$760

Style Number	U.S. Base Prices													
	Fabric Grades:										Leather Grades:			
	COM	6	7	8	9	10	11	12	13	14	COL	C	E	
112401SST	\$954	\$945	\$984	\$1005	\$1028	\$1051	\$1072	\$1095	\$1109	\$1137	\$1038	\$1189	\$1250	

Upholstered Seat

112401SST \$954 \$945 \$984 \$1005 \$1028 \$1051 \$1072 \$1095 \$1109 \$1137 \$1038 \$1189 \$1250

COM/yds = .9, COL/sq ft = 10

Upholstered Seat and Back

112401ST \$990 \$982 \$1020 \$1041 \$1064 \$1087 \$1108 \$1131 \$1145 \$1173 \$1075 \$1285 \$1359

COM/yds = .9, COL/sq ft = 14

Guest/Slider/Stack Seating



For Canadian Pricing
 Multiply U.S. Price by the Canadian price factor.
 ▶ See page 1 for details.

Rocky Jury Bases

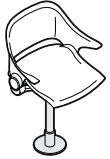

Tip: Rocky seat folds up.

Tip: COM must be approved for use. Call Customer Service at 1.800.627.6770.

Tip: Chairs do not nest.

Tip: Fabrics and leathers will appear loose with comfort wrinkles when upholstered.

Tip: For Customer's Own Material or Leather, see necessary requirements, important processing instructions, and ordering information
 ▶ See Coalesse Surface Materials Reference Guide.

Tip: Jury bases are standard with pneumatic swivel-tilt return mechanism.

Standard Includes	Required to Specify
<ul style="list-style-type: none"> • Seat height: 17½" (may vary slightly by product) • Jury base with memory return and 180 degree swivel • Base is made up of 2½"-diameter column and 8" base plate: 4134 black only • Hardware for floor attachment not included 	1 Style number 2 Options, if selected (see below)

Options	U.S. Price	Required to Specify
Surface Materials • Fire code seating • CAL 133	+\$113	Specify with CAL 133. ▶ See Coalesse Surface Materials Reference Guide.
• Acrylic backer • Backer	+\$ 7	Specify with acrylic backer. ▶ See Coalesse Surface Materials Reference Guide.
Related Products • Rocky		▶ Page 281

Specification Information													
Style Number	U.S. Base Prices											Leather Grades:	
	Fabric Grades:											COL	C
	COM	6	7	8	9	10	11	12	13	14			

Rocky

Non-Upholstered Seat

112301J	\$ 830	N.A.	N.A.	N.A.	N.A.	N.A.	N.A.	N.A.	N.A.	N.A.	N.A.	N.A.	N.A.
---------	--------	------	------	------	------	------	------	------	------	------	------	------	------

Upholstered Seat

112401SJ	\$1021	\$1006	\$1051	\$1072	\$1095	\$1118	\$1139	\$1162	\$1176	\$1204	\$1100	\$1311	\$1385
----------	--------	--------	--------	--------	--------	--------	--------	--------	--------	--------	--------	--------	--------

Upholstered Seat and Back

112401J	\$1060	\$1046	\$1090	\$1111	\$1134	\$1157	\$1178	\$1201	\$1215	\$1243	\$1140	\$1410	\$1496
---------	--------	--------	--------	--------	--------	--------	--------	--------	--------	--------	--------	--------	--------



For Canadian Pricing
 Multiply U.S. Price by the Canadian price factor.
 ▶ See page 1 for details.

SW_1 Guest Seating

DESIGN SCOTT WILSON & MINIMAL DESIGN ORIGIN: UNITED STATES

Tip: For Customer's Own Material or Leather, see necessary requirements, important processing instructions, and ordering information
 ▶ See *Coalesse Surface Materials Reference Guide*.

Standard Includes	Required to Specify
<ul style="list-style-type: none"> • Seat: fabric or leather • Back: 3D knit • Base: 8040 Aluminum Matte Polished • Frame: steel tube • Glides: aluminum with non marring plastic insert • Casters, if selected: dual wheel hard casters, black only • Swivel return mechanism on guest chair, if selected • Swivel mechanism on conference chair, if selected 	1 Style number 2 Upholstery color number for seat 3 3D Knit color number for back: 5K20 Stone 5K21 Grey 5K23 Brown 5K24 Black 5K25 Garnet 5K26 Golden 5K27 Royal 5K28 Ivory 5K29 Coal 4 Options, if selected (see below) ▶ See <i>Coalesse Surface Materials Reference Guide</i> .

	Options	U.S. Price	Required to Specify
Surface Materials	• Contrasting fabric	+\$113 per fabric	Add suffix K to the style number and select fabric color number.
	Fire code seating		
	• CAL 133 for chair	+\$218	Specify with CAL 133.
Mechanism	Acrylic backer		
	• Backer	+\$ 27	Specify with acrylic backer. ▶ See <i>Coalesse Surface Materials Reference Guide</i> .
Casters	• Swivel-only mechanism (omit return feature)	No cost	Specify with swivel-only mechanism.
	• Black soft casters	+\$ 20	Specify with soft casters.
	• Hard black casters with polished aluminum body	+\$ 61	Specify with hard polished aluminum casters.
Related Products	• Soft black casters with polished aluminum body	+\$ 92	Specify with soft polished aluminum casters.
	• Occasional and conference tables		▶ See <i>Coalesse Conferencing and Storage Specification Guide</i> .

Specification Information														
Style Number	U.S. Base Prices											Leather Grades:		
	Fabric Grades:											COL	C	E
	COM	6	7	8	9	10	11	12	13	14				

Guest Swivel Return Chairs with Glides

COW412	\$1719	\$1753	\$1794	\$1829	\$1906	\$1966	\$2005	\$2034	\$2163	\$2341	\$1935	\$2700	\$2808
COM/yds = 3, COL/sq ft = 60													



Overall: 25¼"D 28"W 31½"H
 Seat: 18"H
 Arm: 25¼"H

Conference Swivel Chairs, Height Adjustable with Casters

COW414	\$1719	\$1753	\$1794	\$1829	\$1906	\$1966	\$2005	\$2034	\$2163	\$2341	\$1935	\$2700	\$2808
COM/yds = 3, COL/sq ft = 60													



Overall: 25¼"D 28"W 29½"H-33"H
 Seat: 16¼"H-19¾"H
 Arm: 23½"H-27"H

Guest/Slider/Stack Seating

Switch Guest

DESIGN EOOS DESIGN ORIGIN: GERMANY

Tip: Fabrics and leathers will appear loose with comfort wrinkles when upholstered.

Tip: Recommended leathers are Elmosoft Grade C and Elmorustical Grade E.

Tip: Special color match, consult customer service.

Tip: For Customer's Own Material or Leather, see necessary requirements, important processing instructions, and ordering information
 ▶ See *Coalesse Surface Materials Reference Guide*.

Tip: Pricing based on highest grade textile specified.

Tip: Steel springs allow back to flex to match occupant's back shape.

Tip: Upholstered arm caps fit firmly on arms in coordinating textiles, COM yardage required 1/4 yards, COL square feet required 5/2 (1519 and 1529 only).

Tip: Glide on sled base chair has a felt pad made for hard floors. Movement on carpet is more difficult.

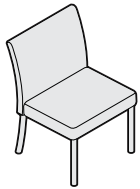

Overall: 22½"D 21½"W 33½"H
Inside: 18½"D 19¼"W 15½"H
Seat: 18½"H

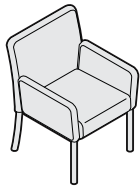

Overall: 22½"D 25¾"W 33½"H
Inside: 18½"D 19"W 15½"H
Seat: 18½"H
Arm: 26½"H



Overall: 23½"D 23¼"W 34¼"H
Inside: 18"D 17¾"W 15½"H
Seat: 18½"H
Arm: 26½"H

Standard Includes	Required to Specify
-------------------	---------------------

- Frame: Constructed of steel tubing and bar stock
- Arms: solid steel rod and bar stock
- Upholstery: Back and seat are molded foam and fiber
- Legs: trivalent matte chrome (M) or polished chrome (PC) leg finish

- 1 Style number
 - 2 Number of fabrics if contrasting fabric style number is selected
 - 3 Fabric or leather color number for upholstery on seat
 - 4 Options, if selected (see below)
- ▶ See *Coalesse Surface Materials Reference Guide*.

Options	U.S. Price	Required to Specify
---------	------------	---------------------

Surface Materials	• Contrasting fabric	+\$ 113 per fabric	Add suffix K to the style number and select fabric color number.
	Fire code seating		
	• CAL 133	+\$ 113	Specify with CAL 133. ▶ See <i>Coalesse Surface Materials Reference Guide</i> .
	Acrylic backer		
	• Backer for armless chair and lowback sledbase	+\$ 17	Specify with acrylic backer.
	• Backer for highback sledbase	+\$ 19	Specify with acrylic backer.
	• Backer for arm chair	+\$ 23	Specify with acrylic backer. ▶ See <i>Coalesse Surface Materials Reference Guide</i> .

Specification Information

Style Number	U.S. Base Prices													
	Fabric Grades:											Leather Grades:		
	COM	6	7	8	9	10	11	12	13	14	COL	C	E	

Armless Chair

1500M	\$1084	\$1092	\$1108	\$1114	\$1137	\$1159	\$1205	\$1240	\$1293	\$1403	\$1341	\$2041	\$2165
1500PC	\$1123	\$1125	\$1147	\$1153	\$1183	\$1204	\$1239	\$1279	\$1336	\$1452	\$1380	\$2080	\$2205

COM/yds = 1½, COL/sq ft = 33

Arm Chair

1510M	\$1209	\$1257	\$1279	\$1296	\$1336	\$1376	\$1433	\$1500	\$1591	\$1701	\$1471	\$2655	\$2865
1510PC	\$1254	\$1290	\$1319	\$1335	\$1381	\$1410	\$1478	\$1534	\$1627	\$1741	\$1516	\$2687	\$2910

COM/yds = 2½, COL/sq ft = 55

Lowback Sledbase

1519M	\$1254	\$1278	\$1297	\$1307	\$1341	\$1375	\$1421	\$1478	\$1550	\$1673	\$1516	\$2449	\$2625
1519PC	\$1282	\$1306	\$1330	\$1342	\$1381	\$1403	\$1460	\$1506	\$1578	\$1705	\$1544	\$2478	\$2653

COM/yds = 2, COL/sq ft = 44

▶ Specification Information, continued on next page

Coalesse

Switch Guest

DESIGN EOOS DESIGN ORIGIN: GERMANY

► Specification Information, continued from previous page

Specification Information

Style Number	U.S. Base Prices											Leather Grades:		
	Fabric Grades:											COL	C	E
	COM	6	7	8	9	10	11	12	13	14				

Highback Sledbase

1529M	\$1379	\$1415	\$1439	\$1460	\$1495	\$1517	\$1586	\$1637	\$1722	\$1857	\$1646	\$2704	\$2892
1529PC	\$1419	\$1449	\$1479	\$1489	\$1524	\$1546	\$1616	\$1672	\$1753	\$1894	\$1676	\$2739	\$2926

COM/yds = 2¼, COL/sq ft = 50



Overall: 23½"D 24"W 38½"H
 Inside: 17¾"D 17¾"W 15½"H
 Seat: 18½"H
 Arm: 26½"H

Guest/Side/Stack Seating



For Canadian Pricing
 Multiply U.S. Price by the
 Canadian price factor.
 ► See page 1 for details.

Switch Stools without Arms

DESIGN EOOS DESIGN ORIGIN: GERMANY

Tip: Fabrics and leathers will appear loose with comfort wrinkles when upholstered.

Tip: Recommended leathers are Elmosoft Grade C and Elmorustical Grade E.

Tip: Special color match, consult customer service.

Tip: Pricing based on highest grade textile specified.

Tip: For Customer's Own Material or Leather, see necessary requirements, important processing instructions, and ordering information
 ► See *Coalesse Surface Materials Reference Guide*.

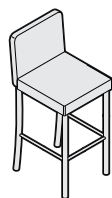

Overall: 19"D 16"W 38"H
 Inside: 15"D 15"W 11¾"H
 Seat: 27¾"H

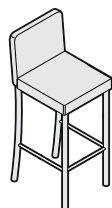

Overall: 19¾"D 16"W 41½"H
 Inside: 15"D 15"W 11¾"H
 Seat: 31¼"H

Standard Includes	Required to Specify
<ul style="list-style-type: none"> • Frame: Constructed of steel tubing and bar stock. • Upholstery: back foam are molded around the frame components. • Seat foam is molded with "comfort pockets" • Legs: Trivalent matte chrome (M) or polished chrome (PC) leg finish 	1 Style number 2 Number of fabrics if contrasting fabric style number is selected 3 Fabric or leather color number for upholstery 4 Options, if selected (see below) ► See <i>Coalesse Surface Materials Reference Guide</i> .

Options	U.S. Price	Required to Specify
Surface Materials <ul style="list-style-type: none"> • Contrasting fabric 	+\$ 113 per fabric	Add suffix K to the style number and select fabric color number.
Fire code seating <ul style="list-style-type: none"> • CAL 133 	+\$ 113	Specify with <i>CAL 133</i> . ► See <i>Coalesse Surface Materials Reference Guide</i> .
Acrylic backer <ul style="list-style-type: none"> • Acrylic backer 	+\$ 10	Specify with <i>acrylic backer</i> . ► See <i>Coalesse Surface Materials Reference Guide</i> .

Specification Information													
Style Number	U.S. Base Prices											Leather Grades:	
	Fabric Grades:											COL	C
COM	6	7	8	9	10	11	12	13	14				

Counter-Height Stool

1404M	\$1186	\$1194	\$1205	\$1216	\$1234	\$1246	\$1280	\$1307	\$1360	\$1489	\$1448	\$2018	\$2125
1404PC	\$1209	\$1217	\$1228	\$1239	\$1262	\$1274	\$1303	\$1336	\$1383	\$1514	\$1471	\$2041	\$2154

COM/yds = 1¼, COL/sq ft = 28

Bar-Height Stool

1405M	\$1220	\$1222	\$1234	\$1244	\$1263	\$1280	\$1307	\$1341	\$1390	\$1523	\$1477	\$2052	\$2159
1405PC	\$1254	\$1256	\$1268	\$1278	\$1290	\$1307	\$1341	\$1381	\$1428	\$1564	\$1516	\$2086	\$2193

COM/yds = 1¼, COL/sq ft = 28



For Canadian Pricing
 Multiply U.S. Price by the Canadian price factor.
 ► See page 1 for details.

Wrapp Side by Viccarbe

DESIGN MARK KRUSIN DESIGN ORIGIN: 2007 SPAIN

Tip: Fabrics and leathers will appear loose with comfort wrinkles when upholstered.

Tip: Stacking is not recommended as the frame will dent the foam on the seat on which it is being stacked.

Tip: For Customer's Own Material or Leather, see necessary requirements, important processing instructions, and ordering information
 ▶ See *Coalesse Surface Materials Reference Guide*.

Standard Includes	Required to Specify
-------------------	---------------------

- Upholstery for chair: fabric or leather
- Frame: polished trivalent chrome

- 1 Style number
 - 2 Number of fabrics if contrasting fabric style number is selected
 - 3 Fabric or leather color number for upholstery
 - 4 Options, if selected (see below)
- ▶ See *Coalesse Surface Materials Reference Guide*.

Options	U.S. Price	Required to Specify
---------	------------	---------------------

Surface Materials

- Contrasting fabric

+\$ 113 per fabric

Add suffix K to the style number and select fabric color number.

Fire code seating

- CAL 133

+\$ 113

Specify with CAL 133.
 ▶ See *Coalesse Surface Materials Reference Guide*.

Acrylic backer

- Backer

+\$ 12

Specify with acrylic backer.
 ▶ See *Coalesse Surface Materials Reference Guide*.

Specification Information

Style Number	U.S. Base Prices										Leather Grades:		
	Fabric Grades:										COL	C	E
	COM	6	7	8	9	10	11	12	13	14			

Four Leg Chair

COWRP4LEG	\$1071	\$1072	\$1085	\$1094	\$1115	\$1131	\$1179	\$1212	\$1282	\$1370	\$1287	\$1856	\$1963
-----------	--------	--------	--------	--------	--------	--------	--------	--------	--------	--------	--------	--------	--------

COM/yds = 1½, COL/sq ft = 33



Overall: 21"D 25¼"W 29½"H
 Inside: 16"D 19½"W 17½"H
 Seat: 17½"H

Sled Base Chair

COWRPSLD	\$1110	\$1111	\$1124	\$1133	\$1154	\$1170	\$1218	\$1251	\$1321	\$1409	\$1326	\$1895	\$2002
----------	--------	--------	--------	--------	--------	--------	--------	--------	--------	--------	--------	--------	--------

COM/yds = 1½, COL/sq ft = 33



Overall: 20¼"D 24½"W 28¾"H
 Inside: 16"D 19½"W 17½"H
 Seat: 17½"H



For Canadian Pricing
 Multiply U.S. Price by the Canadian price factor.
 ▶ See page 1 for details.

X-Stack Four-Leg Stacking Chairs

DESIGN JOHN KALOUSTIAN

 = Available in Rapid10.

Tip: Stacks four chairs with arms on the floor.

Tip: Stacks five chairs without arms on the floor.

Tip: Stacks three chairs with tablets on the floor.

Tip: Chairs stack with cup holder.

Tip: Add 2 2/5" to overall depth and height for each additional chair that is stacked.

Tip: All tablets are specified from the seated position.

Tip: Please contact customer service for soft caster option.

Standard Includes	Required to Specify
-------------------	---------------------

- Frame: tubular 14-gauge steel front legs and shell supports and tubular 17-gauge double lined steel back legs
- Glides, if selected: black glass-filled nylon
- Casters, if selected: hard, dual-wheel for use on carpet: black
- Shell: patented co-molded black glass-filled nylon and pliable thermoplastic polyurethane (TPU) with textured finishes
- Arms, if selected: tubular steel with arm caps in black glass-filled nylon
- Stacking bumpers under shell, a cushion and spacer for stacking: black TPU
- Cal 133 compliant: no upcharge.
- Tablet: black phenolic

- 1 Style number
- 2 Powder coat color number for frame:
 - 4142 Platinum Gloss
 - 4144 Black Gloss
- 3 TPU color number for seat and back:
 - 6328 Cloud (light grey)
 - 6329 Shadow (dark grey)
 - 6330 Sea (blue)
 - 6331 Surf (green)
- 4 Options, if selected (see below)

Options	U.S. Price	Required to Specify
---------	------------	---------------------

Cup Holder	<ul style="list-style-type: none"> • 2 3/4"W x 2"D, rotates around arm support to accommodate user preference: black glass-filled nylon 	+\$ 16 Specify with cup holder.
Storage Rack	<ul style="list-style-type: none"> • Storage rack 	+\$141 Specify with storage rack.
Casters	<ul style="list-style-type: none"> • Soft, dual-wheel casters for use on hard floors 	+\$ 36 Specify with soft casters.

Specification Information

Style Number	U.S. Base Price
--------------	-----------------



Overall: 24"D x 21"W x 33"H
 Inside: 17 3/4"D x 18 1/2"W x 16 1/2"H
 Seat: 17 1/4"H

Non-Upholstered without Arms

On Glides

 X1000 \$346

On Casters

 X1000C \$346



Overall: 24"D x 26"W x 33"H
 Inside: 17 3/4"D x 18 1/2"W x 16 1/2"H
 Seat: 17 1/4"H
 Arms: 26 3/4"H

Non-Upholstered with Arms

On Glides

X2200 \$462

On Casters

X2200C \$462

► Specification Information, continued on next page



For Canadian Pricing
 Multiply U.S. Price by the Canadian price factor.
 ► See page 1 for details.

X-Stack Four-Leg Stacking Chairs

DESIGN JOHN KALOUSTIAN

► Specification Information, continued from previous page

Specification Information

Style U.S.
Number Base
Price



Overall: 28¾"D x 25"W x 33"H
Inside: 17¾"D x 18½"W x 16½"H
Tablet: 12"D x 16"W x 29½"H
Seat: 17¼"H

Non-Upholstered without Arm, Right Tablet

On Glides

X1010 \$531

On Casters

X1010C \$531



Overall: 28¾"D x 29"W x 33"H
Inside: 17¾"D x 18½"W x 16½"H
Tablet: 12"D x 16"W x 29½"H
Seat: 17¼"H

Non-Upholstered with Arm, Right Tablet

On Glides

X2210 \$587

On Casters

X2210C \$587



Overall: 28¾"D x 25"W x 33"H
Inside: 17¾"D x 18½"W x 16½"H
Tablet: 12"D x 16"W x 29½"H
Seat: 17¼"H

Non-Upholstered without Arm, Left Tablet

On Glides

X1010L \$531

On Casters

X1010CL \$531



Overall: 28¾"D x 29"W x 33"H
Inside: 17¾"D x 18½"W x 16½"H
Tablet: 12"D x 16"W x 29½"H
Seat: 17¼"H

Non-Upholstered with Arm, Left Tablet

On Glides

X2210L \$587

On Casters

X2210CL \$587



For Canadian Pricing
Multiply U.S. Price by the
Canadian price factor.

► See page 1 for details.

Executive Seating

Bindu	294
Chord	296
La Costa Couture	298
La Costa Sport	300
Maestro	302
Executive Chair Bases	304
Adjustment Feature Definitions	305
Jury Bases	
Kart	274
Rocky	284

Bindu

DESIGN BRIAN KANE DESIGN ORIGIN: 2009 UNITED STATES

Tip: Fabrics and leathers will appear loose with comfort wrinkles when upholstered.

Tip: For Customer's Own Material or Leather, see necessary requirements, important processing instructions, and ordering information
 ▶ See *Coalesse Surface Materials Reference Guide*.

Tip: Craft in upholstery cautions the use of stripes and patterns on Bindu. Please use fabric database when specifying.

Tip: For fabric with a large pattern and a specific pattern location is desired, contact Customer Service.

Standard Includes	Required to Specify
-------------------	---------------------

- Bent plywood frame
- Chair: fabric
- Molded polypropylene foam
- Frame (Guest/Side): 4144 Black Gloss
- Base (Executive): 6205 Black Resin
- Dual wheel hard casters, executive
- Glides: non-marring polymer, guest
- Back tilt lock

- 1 Style number
 - 2 Fabric or leather color number for upholstery
 - 3 Options, if selected (see below)
- ▶ See *Coalesse Surface Materials Reference Guide*.

Options	U.S. Price	Required to Specify
---------	------------	---------------------

Surface Materials	Acrylic backer		
	• Backer for low back and mid back chair	+\$ 27	Specify with acrylic backer.
	• Backer for high back chair	+\$ 29	Specify with acrylic backer. ▶ See <i>Coalesse Surface Materials Reference Guide</i> .
	Fire code seating		
	• CAL 133	+\$245	Specify with CAL 133 ▶ See <i>Coalesse Surface Materials Reference Guide</i> .
Base	• Polished aluminum (available on CO300 & CO400)	+\$136	Specify with polished aluminum.
	• Polished trivalent chrome (available on CO200G & CO300G)	+\$136	Specify with trivalent chrome.
Casters	• Soft casters (available on CO300 & CO400)	+\$ 21	Specify with soft casters.

Specification Information

Style Number	U.S. Base Prices												Leather Grades:		
	Fabric Grades:												COL	C	E
	COM	6	7	8	9	10	11	12	13	14					

Mid Back Executive/Conference Chair

CO300	\$1285	\$1326	\$1351	\$1370	\$1409	\$1442	\$1540	\$1604	\$1818	\$1930	\$1501	\$2678	\$2892
-------	--------	--------	--------	--------	--------	--------	--------	--------	--------	--------	--------	--------	--------

COM/yds = 3, COL/sq ft = 66



Overall: 25"D 25"W 35½"-40¼"H
 Inside: 18¾"D 18½"-19½"W 21"H
 Seat: 16"-20½"H
 Arm: 24¼"-29"H

High Back Executive/Conference Chair

CO400	\$1501	\$1548	\$1575	\$1598	\$1639	\$1674	\$1780	\$1850	\$2082	\$2188	\$1717	\$2995	\$3227
-------	--------	--------	--------	--------	--------	--------	--------	--------	--------	--------	--------	--------	--------

COM/yds = 3.25, COL/sq ft = 72



Overall: 25"D 25"W 45½"-50¼"H
 Inside: 18¾"D 18½"-19½"W 31"H
 Seat: 16"-20½"H
 Arm: 24¼"-29"H

▶ Specification Information, continued on next page



For Canadian Pricing
 Multiply U.S. Price by the Canadian price factor.
 ▶ See page 1 for details.

Bindu

DESIGN BRIAN KANE DESIGN ORIGIN: 2009 UNITED STATES

► Specification Information, continued from previous page

Specification Information

Style Number	U.S. Base Prices											Leather Grades:		
	Fabric Grades:											COL	C	E
	COM	6	7	8	9	10	11	12	13	14				

Low Back Guest/Side Chair

CO200G	\$1065	\$1106	\$1131	\$1150	\$1189	\$1222	\$1320	\$1384	\$1455	\$1710	\$1281	\$2458	\$2672
--------	--------	--------	--------	--------	--------	--------	--------	--------	--------	--------	--------	--------	--------

COM/yds = 3, COL/sq ft = 66



Overall: 25"D 25"W 33¼"H
 Inside: 18¾"D 18½"-19½"W 15"H
 Seat: 17¾"H
 Arm: 26¼"H

Mid Back Guest/Side Chair

CO300G	\$1230	\$1271	\$1296	\$1315	\$1354	\$1387	\$1485	\$1549	\$1620	\$1875	\$1446	\$2623	\$2837
--------	--------	--------	--------	--------	--------	--------	--------	--------	--------	--------	--------	--------	--------

COM/yds = 3, COL/sq ft = 66



Overall: 25"D 25"W 37¾"H
 Inside: 18¾"D 18½"-19½"W 21"H
 Seat: 17¾"H
 Arm: 26¼"H



For Canadian Pricing
 Multiply U.S. Price by the
 Canadian price factor.
 ► See page 1 for details.

Chord

DESIGN MICHAEL SHIELDS DESIGN ORIGIN: UNITED STATES

Tip: Fabrics and leathers will appear loose with comfort wrinkles when upholstered.

Tip: For Customer's Own Material or Leather, see necessary requirements, important processing instructions, and ordering information
 ▶ See *Coalesse Surface Materials Reference Guide*.

Tip: Arm is cast from 100% recycled material then hand buffed to a mirror finish. Arm caps are molded in black.

Tip: List price based on highest fabric grade usage.

Tip: Contrasting option available only on 798-P and 796-P.

Tip: Chord does not pass CAL 133 with urethane arms. To choose the CAL 133 option polished aluminum arms must be selected.

Standard Includes	Required to Specify
<ul style="list-style-type: none"> • Frame: hardwood plywood assembled into unibody structures utilizing interlocking finger joinery • Cushioning: <ul style="list-style-type: none"> - back: multiple laminations of high-density polyurethane foam over an elastic sheet suspension system for lumbar support - seat: closed cell, contour molded urethane foam • Upholstery: <ul style="list-style-type: none"> - seams are double needle stitched with seam binding for extended durability - unique wrap around welt detail and is cut from the same fabric as specified on chair • Arms: resilient self-skinned urethane molded around carbon steel armature, black or aluminum arm with urethane cap, if selected • Chair controls: tilt-swivel with tilt tension, pneumatic height adjustment, and tilt lockout • Bases: five star black resin • Casters: black hooded dual wheel 	<ol style="list-style-type: none"> 1 Style number 2 Number of fabrics if contrasting fabric style number is selected 3 Fabric or leather color number for upholstery on seat and back 4 Options, if selected (see below) ▶ See <i>Coalesse Surface Materials Reference Guide</i> .

Options	U.S. Price	Required to Specify
Surface Materials <ul style="list-style-type: none"> • Welt detail • Contrasting fabric welt +\$ 57 • Contrasting leather welt +\$ 89 • Contrasting fabric +\$113 per fabric 		Specify with <i>contrasting fabric welt</i> and select fabric color number. Specify with <i>contrasting leather welt</i> and select fabric color number. Add suffix K to the style number and select fabric color number.
<ul style="list-style-type: none"> • Fire code seating • CAL 133 +\$218 		Specify with <i>CAL 133</i> . ▶ See <i>Coalesse Surface Materials Reference Guide</i> .
<ul style="list-style-type: none"> • Acrylic backer • Backer for conference, midback, and high back large chairs +\$ 19 • Backer for high back large chair +\$ 21 • Backer for midback with pillow chairs +\$ 27 • Backer for high back with pillow chairs +\$ 29 		Specify with <i>acrylic backer</i> . Specify with <i>acrylic backer</i> . Specify with <i>acrylic backer</i> . Specify with <i>acrylic backer</i> . ▶ See <i>Coalesse Surface Materials Reference Guide</i> .
Base <ul style="list-style-type: none"> • Polished aluminum with black, hooded dual wheel casters +\$ 57 		Specify with <i>polished aluminum base</i> .
Casters <ul style="list-style-type: none"> • Soft wheel casters +\$ 46 		Specify with <i>soft casters</i> .
Control <ul style="list-style-type: none"> • Knee-tilt with pneumatic height adjustment and tilt lockout +\$143 		Specify with <i>knee-tilt</i> .

Specification Information

Style Number	U.S. Base Prices												Leather Grades:		
	Fabric Grades:												COL	C	E
	COM	6	7	8	9	10	11	12	13	14					

Conference Narrow/Narrow with Urethane Arms													
795	\$1007	\$1033	\$1053	\$1071	\$1093	\$1119	\$1188	\$1241	\$1301	\$1421	\$1250	\$1961	\$2093
COM/yds = 2, COL/sq ft = 40													

Conference Narrow/Narrow with Aluminum Arms													
795AU	\$1349	\$1375	\$1395	\$1413	\$1435	\$1461	\$1530	\$1583	\$1643	\$1763	\$1592	\$2303	\$2435
▶ Specification Information, continued on next page													



Overall: 26½"D 26½"W 36"-39"H
 Inside: 18"D 20"W 18½"H
 Seat: 18½"-21½"H
 Arm: 25¾"-28¾"H

Chord

DESIGN MICHAEL SHIELDS DESIGN ORIGIN: UNITED STATES

► Specification Information, continued from previous page

Specification Information

Style Number	U.S. Base Prices											Leather Grades:		
	Fabric Grades:											COL	C	E
	COM	6	7	8	9	10	11	12	13	14				



Overall: 26½"D 26½"W 38"-41"H
 Inside: 19"D 21½"W 21½"H
 Seat: 21½"H
 Arm: 25¾"-28¾"H

Midback with Urethane Arms

796	\$1131	\$1152	\$1172	\$1187	\$1210	\$1241	\$1312	\$1359	\$1425	\$1562	\$1374	\$2085	\$2210
-----	--------	--------	--------	--------	--------	--------	--------	--------	--------	--------	--------	--------	--------

COM/yds = 2, COL/sq ft = 40

Midback with Aluminum Arms

796AU	\$1473	\$1494	\$1514	\$1529	\$1552	\$1583	\$1654	\$1701	\$1767	\$1904	\$1716	\$2427	\$2552
-------	--------	--------	--------	--------	--------	--------	--------	--------	--------	--------	--------	--------	--------



Overall: 26½"D 26½"W 38"-41"H
 Inside: 18½"D 21½"W 19"H
 Seat: 19"-22"H
 Arm: 25¾"-28¾"H

Midback/Pillow Upholstery with Urethane Arms

796-P	\$1373	\$1429	\$1452	\$1472	\$1520	\$1554	\$1665	\$1737	\$1833	\$1994	\$1616	\$2700	\$2895
-------	--------	--------	--------	--------	--------	--------	--------	--------	--------	--------	--------	--------	--------

COM/yds = 3, COL/sq ft = 60

Midback/Pillow Upholstery with Aluminum Arms

796-PAU	\$1715	\$1771	\$1794	\$1814	\$1862	\$1896	\$2007	\$2079	\$2175	\$2336	\$1958	\$3042	\$3237
---------	--------	--------	--------	--------	--------	--------	--------	--------	--------	--------	--------	--------	--------



Overall: 26½"D 26½"W 44½"-47½"H
 Inside: 18"D 20"W 18½"H
 Seat: 18½"-21½"H
 Arm: 25¾"-28¾"H

High Back Narrow/Narrow with Urethane Arms

797	\$1409	\$1435	\$1460	\$1473	\$1495	\$1519	\$1590	\$1643	\$1703	\$1884	\$1652	\$2210	\$2340
-----	--------	--------	--------	--------	--------	--------	--------	--------	--------	--------	--------	--------	--------

COM/yds = 2, COL/sq ft = 44

High Back Narrow/Narrow with Aluminum Arms

797AU	\$1751	\$1777	\$1802	\$1815	\$1837	\$1861	\$1932	\$1985	\$2045	\$2226	\$1994	\$2552	\$2682
-------	--------	--------	--------	--------	--------	--------	--------	--------	--------	--------	--------	--------	--------



Overall: 26½"D 26½"W 47"-50"H
 Inside: 19"D 21½"W 18½"H
 Seat: 18½"-21½"H
 Arm: 25¾"-28¾"H

High Back/Large Scale with Urethane Arms

798	\$1421	\$1447	\$1467	\$1485	\$1507	\$1531	\$1602	\$1655	\$1715	\$1898	\$1670	\$2217	\$2347
-----	--------	--------	--------	--------	--------	--------	--------	--------	--------	--------	--------	--------	--------

COM/yds = 2¼, COL/sq ft = 44

High Back/Large Scale with Aluminum Arms

798AU	\$1763	\$1789	\$1809	\$1827	\$1849	\$1873	\$1944	\$1997	\$2057	\$2240	\$2012	\$2559	\$2689
-------	--------	--------	--------	--------	--------	--------	--------	--------	--------	--------	--------	--------	--------



Overall: 26½"D 26½"W 47"-50"H
 Inside: 19"D 21½"W 19"H
 Seat: 19"-22"H
 Arm: 26¾"-28¾"H

High Back/Large Scale with Pillow Upholstery with Urethane Arms

798-P	\$1498	\$1549	\$1572	\$1597	\$1645	\$1679	\$1785	\$1862	\$1958	\$2137	\$1741	\$2819	\$3013
-------	--------	--------	--------	--------	--------	--------	--------	--------	--------	--------	--------	--------	--------

COM/yds = 3, COL/sq ft = 66

High Back/Large Scale with Pillow Upholstery with Aluminum Arms

798-PAU	\$1840	\$1891	\$1914	\$1939	\$1987	\$2021	\$2127	\$2204	\$2300	\$2479	\$2083	\$3161	\$3355
---------	--------	--------	--------	--------	--------	--------	--------	--------	--------	--------	--------	--------	--------



Tip: Closed arm version is not available.

Tip: Due to the design and construction techniques of the La Costa Couture, only certain textiles can be successfully applied. Therefore all COM fabrics must be submitted to Coalesse for approval prior to order acceptance. A pre-approved fabric list is available, contact Customer Service.

Tip: Your specification is not complete until suffixes have been chosen.

Tip: Fabrics and leathers will appear loose with comfort wrinkles when upholstered.

Tip: For Customer's Own Material or Leather, see necessary requirements, important processing instructions, and ordering information
 ▶ See Coalesse Surface Materials Reference Guide.

Standard Includes	Required to Specify
<ul style="list-style-type: none"> Frame: internal frame is constructed of a contour molded hardwood veneer shell which provides proper support of the lumbar region of the back Upholstery: multiple laminations of high density polyurethane and polyester fiber Arms: <ul style="list-style-type: none"> - wood: laminated maple hardwood veneers with black self-skinned urethane arm caps - self-skinned urethane arms are molded with high carbon steel substructures - arms and arm caps: black Chair control: tilt swivel control with tilt tension adjustment available with: <ul style="list-style-type: none"> S = Standard - mechanical height adjustment, if selected P = Pneumatic - gas assisted height adjustment, if selected Bases: <ul style="list-style-type: none"> S = S base - five arm polished aluminum with black column, black hood dual wheel casters standard W = Wood base - five arm solid maple with aluminum understructure, black column, black hood dual wheel casters, if selected 	<ol style="list-style-type: none"> Style number Fabric or leather color number for upholstery on seat and back Powder coat or wood color number for base, if selected <p>▶ See Coalesse Surface Materials Reference Guide.</p> <ol style="list-style-type: none"> Options, if selected (see below) <p>▶ See Coalesse Surface Materials Reference Guide.</p>

Options	U.S. Price	Required to Specify
Surface Materials <ul style="list-style-type: none"> Fire code seating <ul style="list-style-type: none"> CAL 133 +\$218 Acrylic backer <ul style="list-style-type: none"> Backer for conference and mid back chairs +\$ 29 Backer for high back chairs +\$ 33 		Specify with CAL 133. ▶ See Coalesse Surface Materials Reference Guide. Specify with acrylic backer. Specify with acrylic backer. ▶ See Coalesse Surface Materials Reference Guide.
Arms <ul style="list-style-type: none"> Wood arms with black urethane caps +\$170 Upholstered arm caps on wood, polished aluminum, or self-skinned urethane arms (5 sq. ft. or 1/2 yard) +\$ 57 Polished aluminum open arms with black urethane caps +\$450 		Specify with wood arms with black urethane caps. Specify with upholstered arm caps. Specify with polished aluminum open arms black urethane caps.
Base <ul style="list-style-type: none"> Polished aluminum base No cost Black powder coat with black column and casters No cost Resin base -\$ 28 		Specify with polished aluminum base. Specify with black powder coat. Specify with resin base.
Control <ul style="list-style-type: none"> Knee-tilt with pneumatic height adjustment (available on P version style number only) +\$125 		Specify with knee-tilt.
Caster <ul style="list-style-type: none"> Soft wheel casters +\$ 46 		Specify with soft casters.



For Canadian Pricing
 Multiply U.S. Price by the Canadian price factor.
 ▶ See page 1 for details.

Specification Information

Style Number	U.S. Base Prices											Leather Grades:	
	Fabric Grades:											COL	C
	COM	6	7	8	9	10	11	12	13	14			



Overall: 24¼"D 23¾"W 33"H
 Inside: 18½"D 19"W 14½"H
 Seat: 18½"-22"H
 Arm: 24¼"-27¾"H

Conference with Open Urethane Arm

996SS	\$1581	\$1714	\$1739	\$1756	\$1862	\$1987	\$2094	\$2272	\$2387	\$2545	\$1859	\$2808
996PS	\$1645	\$1792	\$1808	\$1826	\$1932	\$2068	\$2164	\$2341	\$2521	\$2698	\$1934	\$2877
996SW	\$1787	\$1926	\$1950	\$1968	\$2074	\$2199	\$2300	\$2480	\$2575	\$2750	\$2065	\$3009
996PW	\$1858	\$1997	\$2016	\$2039	\$2139	\$2276	\$2377	\$2551	\$2646	\$2821	\$2147	\$3080

COM/yds = 3, COL/sq ft = 54



Overall: 24¼"D 25¾"W 36"H
 Inside: 18½"D 21"W 17½"H
 Seat: 18½"-22"H
 Arm: 24¼"-27¾"H

Mid Back with Open Urethane Arm

997SS	\$1610	\$1749	\$1768	\$1791	\$1891	\$2016	\$2123	\$2291	\$2466	\$2642	\$1899	\$2832
997PS	\$1692	\$1819	\$1850	\$1867	\$1968	\$2098	\$2197	\$2373	\$2548	\$2724	\$1970	\$2900
997SW	\$1822	\$1961	\$1980	\$1997	\$2103	\$2228	\$2335	\$2503	\$2678	\$2854	\$2111	\$3007
997PW	\$1900	\$2027	\$2063	\$2081	\$2176	\$2306	\$2405	\$2581	\$2756	\$2932	\$2178	\$3115

COM/yds = 3¼, COL/sq ft = 59



Overall: 24¼"D 25¾"W 41"H
 Inside: 18½"D 21"W 22½"H
 Seat: 18½"-22"H
 Arm: 24¼"-27¾"H

High Back with Open Urethane Arm

998SS	\$2060	\$2207	\$2218	\$2241	\$2352	\$2478	\$2565	\$2741	\$2916	\$3092	\$2349	\$3275
998PS	\$2141	\$2280	\$2293	\$2310	\$2422	\$2547	\$2646	\$2822	\$2997	\$3173	\$2424	\$3332
998SW	\$2278	\$2411	\$2425	\$2447	\$2559	\$2684	\$2778	\$2952	\$3126	\$3300	\$2561	\$3476
998PW	\$2347	\$2494	\$2505	\$2522	\$2634	\$2759	\$2852	\$3028	\$3203	\$3379	\$2636	\$3538

COM/yds = 3¾, COL/sq ft = 68



For Canadian Pricing
 Multiply U.S. Price by the
 Canadian price factor.
 ▶ See page 1 for details.

La Costa Sport

DESIGN PAMELA LIGHT, IIDA DESIGN ORIGIN: UNITED STATES



Tip: Recommended leathers are Elmosoft Grade C and Elmorustical Grade E.

Tip: Special color match, consult customer service.

Tip: For Customer's Own Material or Leather, see necessary requirements, important processing instructions, and ordering information
 ▶ See *Coalesse Surface Materials Reference Guide*.

Tip: The first alpha character in the style number indicates the chair control and the second indicates the type of base.

Tip: Your specification is not complete until suffixes have been chosen.

Tip: Fabrics and leathers will appear loose with comfort wrinkles when upholstered.

Standard Includes	Required to Specify
-------------------	---------------------

- **Frame:** Internal frame is constructed of a contour molded hardwood veneer shell which provides proper support of the lumbar region of the back
- **Sled base models** utilize the same molded veneer shell and are attached to a powder coated steel tubular base: black
- **Upholstery:** multiple laminations of high density polyurethane and polyester fiber
- **Arms:** open arms are constructed of resilient self-skinned urethane molded around a high carbon steel substructure: black
- **Chair control:** tilt swivel control with tilt tension adjustment available with:
 S = Standard - mechanical height adjustment, if selected
 P = Pneumatic - gas assisted height adjustment, if selected
- **Bases:**
 S = S base - five arm polished aluminum with black column, black hood dual wheel casters standard
 W = Wood base - five arm solid maple with aluminum understructure, black column, black hood dual wheel casters, if selected

- 1 Style number
- 2 Fabric or leather color number for upholstery on seat and back
- 3 Powder coat or wood color number for base, if selected
 ▶ See *Coalesse Surface Materials Reference Guide*.
- 4 Options, if selected (see below)
 ▶ See *Coalesse Surface Materials Reference Guide*.

Options	U.S. Price	Required to Specify
---------	------------	---------------------

Surface Materials	Fire code seating		
	• CAL 133	+\$218	Specify with CAL 133. ▶ See <i>Coalesse Surface Materials Reference Guide</i> .
	Acrylic backer		
	• Backer for sled base and conference chairs	+\$ 12	Specify with acrylic backer.
	• Backer for mid back chairs	+\$ 15	Specify with acrylic backer.
	• Backer for high back chairs	+\$ 19	Specify with acrylic backer. ▶ See <i>Coalesse Surface Materials Reference Guide</i> .
Arms	• Wood arms with black urethane caps	+\$170	Specify with wood arms with black urethane caps.
	• Upholstered arm caps on wood, polished aluminum, or self-skinned urethane arms (5 sq. ft. or 1/2 yard)	+\$ 57	Specify with upholstered arm caps.
	• Polished aluminum open arms with black urethane caps	+\$450	Specify with polished aluminum open arms black urethane caps.
Base	• Polished aluminum base	No cost	Specify with polished aluminum base.
	• Black powder coat with black column and casters	No cost	Specify with black powder coat.
	• Resin base	-\$ 28	Specify with resin base.
Control	• Knee-tilt with pneumatic height adjustment (available on P version style number only)	+\$125	Specify with knee-tilt.
Caster	• Soft wheel casters	+\$ 46	Specify with soft casters.



For Canadian Pricing
 Multiply U.S. Price by the Canadian price factor.
 ▶ See page 1 for details.

La Costa Sport

DESIGN PAMELA LIGHT, IIDA DESIGN ORIGIN: UNITED STATES

Specification Information

Style Number	U.S. Base Prices											Leather Grades:		
	Fabric Grades:											COL	C	E
	COM	6	7	8	9	10	11	12	13	14				



Overall: 24¼"D 23¾"W 35½"H
 Inside: 17¼"D 19"W 16"H
 Seat: 19½"H
 Arm: 26¾"H

Sled Base with Open Urethane Arm

990	\$1238	\$1231	\$1259	\$1284	\$1413	\$1466	\$1491	\$1572	\$1589	\$1616	\$1521	\$2016	\$2346
-----	--------	--------	--------	--------	--------	--------	--------	--------	--------	--------	--------	--------	--------

COM/yds = 1½, COL/sq ft = 27



Overall: 24¼"D 23¾"W 33"H
 Inside: 17¼"D 19"W 16"H
 Seat: 17"-20½"H
 Arm: 24¼"-27¾"H

Conference with Open Urethane Arm

991SS	\$1255	\$1253	\$1276	\$1311	\$1436	\$1483	\$1524	\$1589	\$1611	\$1639	\$1544	\$2038	\$2363
991PS	\$1332	\$1325	\$1348	\$1383	\$1507	\$1560	\$1591	\$1671	\$1688	\$1722	\$1615	\$2110	\$2428
991SW	\$1474	\$1459	\$1484	\$1525	\$1649	\$1696	\$1733	\$1803	\$1821	\$1873	\$1752	\$2247	\$2565
991PW	\$1546	\$1539	\$1562	\$1592	\$1715	\$1768	\$1805	\$1880	\$1902	\$1960	\$1829	\$2312	\$2637

COM/yds = 1½, COL/sq ft = 27



Overall: 24¼"D 25¾"W 36"H
 Inside: 17¼"D 21"W 19"H
 Seat: 17"-20½"H
 Arm: 24¼"-27¾"H

Mid Back with Open Urethane Arm

992SS	\$1298	\$1283	\$1319	\$1344	\$1467	\$1532	\$1557	\$1632	\$1649	\$1682	\$1581	\$2081	\$2401
992PS	\$1368	\$1353	\$1389	\$1419	\$1543	\$1596	\$1632	\$1702	\$1724	\$1762	\$1646	\$2141	\$2471
992SW	\$1503	\$1488	\$1529	\$1554	\$1678	\$1737	\$1762	\$1842	\$1854	\$1910	\$1786	\$2281	\$2606
992PW	\$1581	\$1566	\$1597	\$1632	\$1750	\$1809	\$1845	\$1915	\$1937	\$1998	\$1859	\$2347	\$2672

COM/yds = 1¾, COL/sq ft = 32



Overall: 24¼"D 25¾"W 41"H
 Inside: 17¼"D 21"W 24"H
 Seat: 17"-20½"H
 Arm: 24¼"-27¾"H

High Back with Open Urethane Arm

993SS	\$1591	\$1584	\$1607	\$1647	\$1760	\$1819	\$1855	\$1925	\$1966	\$2024	\$2006	\$2357	\$2682
993PS	\$1668	\$1666	\$1689	\$1714	\$1843	\$1896	\$1927	\$1997	\$2043	\$2110	\$2078	\$2422	\$2754
993SW	\$1800	\$1798	\$1821	\$1856	\$1975	\$2028	\$2069	\$2134	\$2179	\$2259	\$2215	\$2559	\$2891
993PW	\$1881	\$1874	\$1897	\$1927	\$2056	\$2109	\$2134	\$2210	\$2253	\$2342	\$2291	\$2629	\$2953

COM/yds = 2, COL/sq ft = 36

Executive Seating



For Canadian Pricing
 Multiply U.S. Price by the
 Canadian price factor.
 ▶ See page 1 for details.

Maestro **X4/14**

DESIGN ROLF GRUNOW DESIGN ORIGIN: GERMANY

Tip: Fabrics and leathers will appear loose with comfort wrinkles when upholstered.

Tip: Recommended leathers are Elmosoft Grade C and Elmorustical Grade E.

Tip: Special color match, consult customer service.

Tip: For Customer's Own Material or Leather, see necessary requirements, important processing instructions, and ordering information
 ▶ See *Coalesse Surface Materials Reference Guide*.

Standard Includes	Required to Specify
<ul style="list-style-type: none"> • Frame: Selected hardwood and veneer frame • Upholstery: <ul style="list-style-type: none"> - Foam and polyester fiber wrapped frame - High density polyurethane foam-filled cushions • Chair control: tilt swivel control with tilt tension stop back mechanism adjustment available with: <ul style="list-style-type: none"> S = Standard - mechanical height adjustment, if selected P = Pneumatic - gas assisted height adjustment, if selected • Bases: <ul style="list-style-type: none"> S = S base - five arm polished aluminum with black column, black hood dual wheel casters standard. Optional at no upcharge: black powder coat with black column and casters, if selected W = Wood base - five arm solid maple with aluminum understructure, black column, black hood dual wheel casters, if selected 	<ol style="list-style-type: none"> 1 Style number 2 Fabric or leather color number for upholstery on seat and back 3 Powder coat or wood finish color number for base 4 Wood color number for base, if selected ▶ See <i>Coalesse Surface Materials Reference Guide</i> . 5 Options, if selected (see below) ▶ See <i>Coalesse Surface Materials Reference Guide</i> .

Options	U.S. Price	Required to Specify
Surface Materials <ul style="list-style-type: none"> • Fire code seating <ul style="list-style-type: none"> • CAL 133 	+\$218	Specify with CAL 133. ▶ See <i>Coalesse Surface Materials Reference Guide</i> .
<ul style="list-style-type: none"> • Acrylic backer <ul style="list-style-type: none"> • Backer for low back chairs • Backer for medium back chairs • Backer for high back chairs 	+\$ 29 +\$ 33 +\$ 37	Specify with acrylic backer. Specify with acrylic backer. Specify with acrylic backer. ▶ See <i>Coalesse Surface Materials Reference Guide</i> .
Base <ul style="list-style-type: none"> • Polished aluminum base • Black powder coat with black column and casters • Resin base 	No cost No cost -\$ 28	Specify with polished aluminum base. Specify with black powder coat. Specify with resin base.
Casters <ul style="list-style-type: none"> • Soft wheel casters 	+\$ 46	Specify with soft casters.

Specification Information															
Style Number	U.S. Base Prices												Leather Grades:		
	Fabric Grades:												COL	C	E
	COM	6	7	8	9	10	11	12	13	14					

Low Back Chair with Tilt Swivel

852SS X4/14	\$2072	\$2146	\$2194	\$2265	\$2359	\$2443	\$2490	\$2548	\$2576	\$2795	\$2338	\$3168	\$3587
852PS X4/14	\$2135	\$2209	\$2268	\$2334	\$2427	\$2511	\$2569	\$2616	\$2642	\$2870	\$2413	\$3243	\$3664
852SW X4/14	\$2274	\$2348	\$2407	\$2473	\$2573	\$2650	\$2703	\$2755	\$2786	\$3031	\$2546	\$3382	\$3803
852PW X4/14	\$2347	\$2421	\$2474	\$2546	\$2634	\$2723	\$2770	\$2828	\$2851	\$3105	\$2625	\$3450	\$3869

COM/yds = 3¼, COL/sq ft = 59

Medium Back Chair with Tilt Swivel

853SS X4/14	\$2116	\$2226	\$2291	\$2380	\$2498	\$2621	\$2681	\$2790	\$2964	\$3138	\$2394	\$3538	\$4010
853PS X4/14	\$2195	\$2299	\$2364	\$2448	\$2577	\$2695	\$2748	\$2869	\$3043	\$3217	\$2461	\$3598	\$4083
853SW X4/14	\$2330	\$2440	\$2499	\$2594	\$2712	\$2835	\$2883	\$3004	\$3178	\$3352	\$2602	\$3733	\$4224
853PW X4/14	\$2403	\$2507	\$2578	\$2656	\$2779	\$2903	\$2962	\$3077	\$3251	\$3425	\$2669	\$3813	\$4286

COM/yds = 3¾, COL/sq ft = 68

▶ Specification Information, continued on next page



Overall: 30¼"D 27¾"W 31¼"-36"H
 Inside: 20"D 20½"W 16¾"H
 Seat: 18½"-23½"H
 Arm: 24"-29"H



Overall: 30¼"D 27¾"W 33¼"-38"H
 Inside: 20"D 20½"W 20¾"H
 Seat: 18½"-23½"H
 Arm: 24"-29"H

X4/14 = Last order entry
 April 20, 2014

Maestro **X4/14**

DESIGN ROLF GRUNOW DESIGN ORIGIN: GERMANY

► Specification Information, continued from previous page

Specification Information

Style Number	U.S. Base Prices											Leather Grades:		
	Fabric Grades:											COL	C	E
	COM	6	7	8	9	10	11	12	13	14				

High Back Chair with Tilt Swivel

859SS X4/14	\$2323	\$2439	\$2504	\$2604	\$2735	\$2858	\$2924	\$2983	\$2986	\$3226	\$2595	\$3833	\$4335
859PS X4/14	\$2391	\$2507	\$2584	\$2667	\$2803	\$2926	\$2998	\$3051	\$3058	\$3307	\$2663	\$3906	\$4409
859SW X4/14	\$2533	\$2649	\$2719	\$2814	\$2945	\$3068	\$3140	\$3193	\$3196	\$3464	\$2805	\$4048	\$4545
859PW X4/14	\$2606	\$2722	\$2787	\$2882	\$3018	\$3141	\$3207	\$3266	\$3273	\$3549	\$2878	\$4116	\$4618

COM/yds = 4 1/4, COL/sq ft = 77



Overall: 32 3/4"D 27 3/4"W 39"-43 3/4"H
 Inside: 20"D 20 1/2"W 26"H
 Seat: 18 1/2"-23 1/2"H
 Arm: 24"-29"H



For Canadian Pricing
 Multiply U.S. Price by the
 Canadian price factor.
 ► See page 1 for details.

X4/14 = Last order entry
 April 20, 2014

Executive Chair Bases

Refer to chair style to determine available base options, wood or metal finishes.



S-Base (Polished Aluminum)



S-Base (Black Powder coat)



Wood Base



Swivel Base with Glides



Resin (Black only) Optional on most models



Chord Base: Five-arm black resin base standard.



Chord optional polished aluminum base.

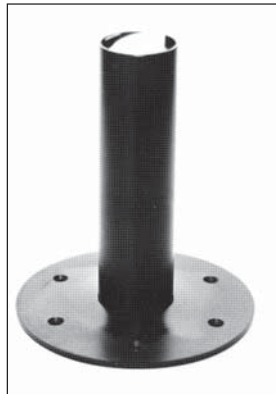

*Jury bases are available for Kart and Rocky. All other requests should be submitted through Specials.

Adjustment Feature Definitions

Active mechanism (AM+) allows the seat and back angle to be adjusted independently of each other. The seat can be locked at various angles, and the back can free tilt with adjustable tension or lock in four positions.

Arms, height adjustable allow the user to independently move each arm up and down.

Arms, width-adjustable allows the arm rests to be adjusted in and out.

Arms, folding allows the user to independently fold each arm up or down for total freedom of leg movement and posture accommodation.

Back, height adjustable allows the user to raise or lower the chair back within a given range.

Back lock, forward allows the user to lock the backrest in a full upright position or release it to recline.

Back stop, selective allows the user to lock and unlock the backrest in any position within the tilt range.

Back tilt tension adjustment regulates the ease of tilt movement of the back only.

Back and seat tilt (Your Power mechanism) automatically responds to the weight and seating position of the user with an individual back resistance.

Base, free swivel allows chair to swivel 360°.

Base, memory-return swivel allows a chair to swivel 360°, but return to the forward-facing position when released.

Base, nesting four-star has two front legs that are lower than the two rear legs, allowing chairs to nest for storage. A nylon tooth on the base engages a notch in the seat when folded. This engagement properly aligns the seat and base for nesting.

Folding seat allows the seat to flip up, while the chair automatically rises for nesting and storage.

Knee tilt control (low front rise) minimizes the rise of the front of the seat when the chair is in a reclined position, allowing the users' feet to remain on the floor. This feature reduces pressure under the thighs, allowing for continuous blood circulation.

Lumbar support, adjustable provides additional lower back comfort by allowing the user to move the lumbar support up or down, as well as increase or decrease the amount of support.

Passive mechanism (PM) allows the seat and back to move in synchronization without manual adjustment.

Pneumatic height allows the user to change the seat height assisted by a pneumatic gas cylinder.

Seat angle adjustment allows the user to change and lock the seat angle in various positions.

Seat depth, adjustable allows the user to slide the seat forward or back within a set range.

Seat tilt control allows the seat and back to rotate as a unit backward one position and forward two positions.

Seat, zero front rise allows the user to tilt back in the chair while feet remain on the floor because the seat front remains level.

Swivel-tilt mechanism control allows the chair to swivel 360° and the fixed seat and back to tilt in unison when the user leans back.

Synchro-tilt mechanism synchronizes the tilting movement of the seat and back in a set ratio.

Tilt tension adjustment allows the user to vary the amount of recline resistance. Your Power mechanism allows the back and seat tilt to adjust automatically to the weight and seating position of the user.

Your Preference control allows the user to adjust the back tilt by selecting one of four settings: weight activated, weight activated with 20% resistance boost, mid-stop recline, and upright back lock.

Occasional Tables

Avon	308
Await	310
Bix	311
Bob	314
Calm Tables Square	316
Calm Tables Oval	317
Calm Tables Rectangle	318
CG_1	320
CH008 Sofa Table	324
CH100 Occasional Table	325
CH327 Dining Table	326
Circa Freestanding Tables	327
Denizen Tablet Table	329
Denizen Console Table	330
Diekman	331
Donovan	332
Enea Tables with Single Base	334
Enea Tables with Twin Base	336
Enea Lottus Occasional Tables	339
Enea Lottus Conference Tables	340
Enea Lottus Café Counter Height Tables	341
Enea Lottus Café Bar Height Tables	342
Enea Lottus Rectangular Tables	343
Free Stand	344
Ginger	346
Holy Day Tables	348
Millbrae	349
Passerelle	350
Sebastopol	351
Sidewalk Occasional Tables	354
Sidewalk Storage	357
Soft Leaf	358
SW_1 Occasional Tables	360
Swathmore Plus	362
Switch	364
TeamWork Satellite Table	365
Trees	368
Interport Power Module	370

Avon

DESIGN JIM BAREFOOT DESIGN ORIGIN: UNITED STATES

Tip: No frame sold separately.

Tip: Interport not available on 192448.

► See Interport power/data module, page 370.

Tip: Specify position of module, centered or off-centered, and provide a sketch.

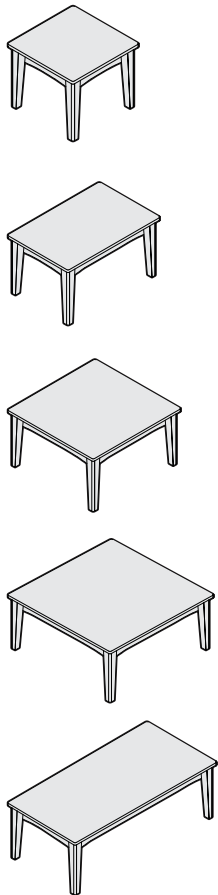

Standard Includes	Required to Specify
<ul style="list-style-type: none"> • Frame: solid maple with dowels and corner braces for structural integrity • Glides: polyethylene • Top: <ul style="list-style-type: none"> - Finesse: ¾" thick, double radius edge with Finesse applied - Wood: ¾" thick, double radius on solid maple edge with selected maple veneer applied 	1 Style number 2 Finesse or wood color number for top ► See <i>Coalesse Surface Materials Reference Guide</i> . 3 Frame finish 4 Options, if selected (see below) ► See <i>Coalesse Surface Materials Reference Guide</i> .

Options	U.S. Price	Required to Specify
Surface Materials <ul style="list-style-type: none"> • Contrasting wood top 	+\$174	Specify with <i>contrasting wood top</i> .
Interport Power/Data Module <ul style="list-style-type: none"> • Available on wood or Finesse tops 	+\$306	Specify with <i>Interport</i> and select finish color number.

Specification Information

Dimensions D W H	Style Number	U.S. Base Prices	
		Top Surface:	
		Finesse	Wood
20" 20" 16½"	192020F	\$1007	N.A.
20" 20" 16½"	192020W	N.A.	\$1239
20" 30" 16½"	192030F	\$1064	N.A.
20" 30" 16½"	192030W	N.A.	\$1392
30" 30" 16½"	193030F	\$1199	N.A.
30" 30" 16½"	193030W	N.A.	\$1526
36" 36" 16½"	193636F	\$1456	N.A.
36" 36" 16½"	193636W	N.A.	\$1948
24" 48" 16½"	192448F	\$1295	N.A.
24" 48" 16½"	192448W	N.A.	\$1891

► Specification Information, continued on next page

► Specification Information, continued from previous page

Specification Information

Dimensions			Style Number	U.S. Base Prices	
D	W	H		Top Surface:	
				Finesse	Wood

20"	20"	21"	212020F	\$1020	N.A.
20"	20"	21"	212020W	N.A.	\$1244

30"	30"	21"	213030F	\$1218	N.A.
30"	30"	21"	213030W	N.A.	\$1559

36"	36"	21"	213636F	\$1507	N.A.
36"	36"	21"	213636W	N.A.	\$2007

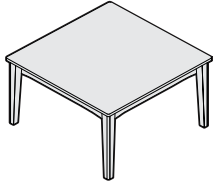
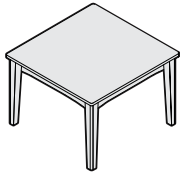
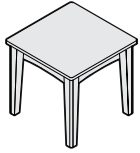

 **For Canadian Pricing**
 Multiply U.S. Price by the
 Canadian price factor.
 ► See page 1 for details.

Await Tables

DESIGN EOOS DESIGN ORIGIN: GERMANY

 = Available in Rapid10.

Tip: Await connector tables are not recommended to be used in end-of-run applications.

Tip: Await connector tables are not made for ganging to Await mobile ottoman.

Standard Includes	Required to Specify
<ul style="list-style-type: none"> Freestanding table frame: silver Connector table frame: panels are black, white, or gray Top: High-Pressure Laminate top with matching 3 mm edge band Glass top (tablet): <ul style="list-style-type: none"> - 1/2" thick - Radiused edges Ganging plate: 1/4" thick ganging plates attach to the bottom of units to the seating unit plates 	1 Style number 2 Laminate top and tablets, if selected: 2595 Black 2730 Arctic White 2906 North Sea 3 Glass color number for top, if selected ▶ See <i>Coalesse Surface Materials Reference Guide</i> .

Specification Information				
Style Number	U.S. Prices			
	Top Surface:			
	Laminate	Clear Green/ Clear Green Frosted Glass Top	Absolute Clear/ Clear Frosted Glass Top	Colored Glass Top

Freestanding Low Round Table

 46-T1	\$ 969	\$1159	\$1180	\$1337
---	--------	--------	--------	--------

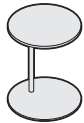

Overall: 15 3/4" Dia. 19"H

Freestanding High Round Table

 46-T2	\$1265	\$1455	\$1476	\$1633
--	--------	--------	--------	--------



Overall: 15 3/4" Dia. 25"H

Specification Information									
Style Number	U.S. Prices								
	Laminate Top:			Glass Tablet:			Absolute Clear/		Colored
	No Tablet	Tablet	Tablet and Power/Data	Clear Green/ Clear Green Frosted Glass Tablet	Clear Green / Clear Green Frosted Tablet and Power/Data	Absolute Clear/ Clear Frosted Glass Tablet	Absolute Clear/ Clear Frosted Tablet and Power/Data	Colored Glass Tablet	Colored Tablet and Power/Data

Connector Tables

460-SE22	\$ 597	\$1371	N.A.	\$1471	N.A.	\$1493	N.A.	\$1650	N.A.
460-SE22PD	N.A.	N.A.	\$1630	N.A.	\$1731	N.A.	\$1752	N.A.	\$1908

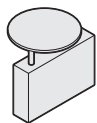

Overall: 20"D 4 1/2"W 15 3/8"H
With Tablet: 15 3/4" Dia. and 25 3/8"H

460-SE30	\$ 684	\$1458	N.A.	\$1558	N.A.	\$1584	N.A.	\$1737	N.A.
460-SE30PD	N.A.	N.A.	\$1720	N.A.	\$1821	N.A.	\$1842	N.A.	\$1998

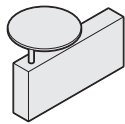

Overall: 28"D 4 1/2"W 15 3/4"H
With Tablet: 15 3/4" Dia. and 25 3/8"H

460-SE44	\$ 839	\$2387	N.A.	\$2515	N.A.	\$2559	N.A.	\$2867	N.A.
460-SE44PD	N.A.	N.A.	\$2642	N.A.	\$2777	N.A.	\$2819	N.A.	\$3133

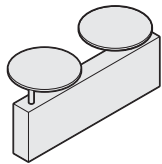

Overall: 42"D 4 1/2"W 25 3/8"H
With Tablets: 15 3/4" Dia. and 25 3/8"H

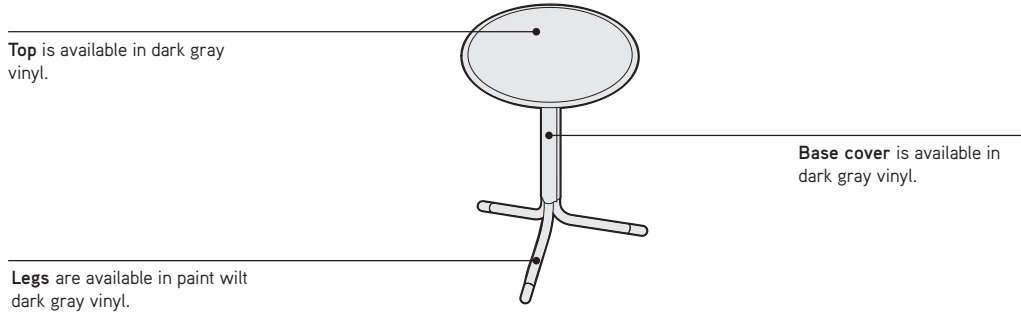

Top is available in dark gray vinyl.

Base cover is available in dark gray vinyl.

Legs are available in paint with dark gray vinyl.

Product Details



Side table offers a freestanding, mobile tablet surface. The tripod base allows it to be positioned close to a seating unit. The top is available in vinyl.

Surface Materials

Side table surface and base cover

- Dark gray vinyl

Side table base

- Paint (vinyl)

Actual Dimension

	Overall	
	Depth	Height
Side table	17" Dia.	23"

Side Table–Vinyl Version



Standard Includes	Required to Specify
-------------------	---------------------

- | | | |
|---|---|---|
| <ul style="list-style-type: none"> ▶ Need help? Product details, page 72 | <ul style="list-style-type: none"> • Base: paint • Table surface and base cover: dark gray vinyl only | <ul style="list-style-type: none"> 1 Style number 2 Paint color number for base ▶ See <i>Coalesse Surface Materials Reference Guide</i>. |
|---|---|---|

Related Products

- | | |
|--|---|
| <ul style="list-style-type: none"> Lounge chairs Sectional seating Podium | <ul style="list-style-type: none"> ▶ Page 82 ▶ Page 84 ▶ Page 92 |
|--|---|

Specification Information			
---------------------------	--	--	--

Dimensions	H	Style Number	U.S. Price
------------	---	--------------	------------

Side Table with Vinyl Surface

17"	23"	BTS1700	\$478
-----	-----	---------	-------

For Canadian Pricing
 Multiply U.S. Price by the Canadian price factor.
 ▶ See page 1 for details.

Bix 18"H Occasional Tables

DESIGN METRO DESIGN GROUP

Standard Includes		Required to Specify
<p>► Need help? Product details, page 72</p>	<ul style="list-style-type: none"> • Top: <ul style="list-style-type: none"> - Laminate top (Grade 1 laminates) with matching plastic edge - Laminate top (Grade 1 Steelcase) with contrasting plastic edge - Wood top with matching flat wood edge • Base: textured paints only • Grommet, if selected: black plastic only 	<p>1 Style number 2 Laminate or wood color number for top ► See <i>Coalesse Surface Materials Reference Guide</i>. 3 Plastic edge color number for top with Grade 1 Steelcase or Grade 2 laminate, if selected 4 Textured paint color number for base 5 Options, if selected (see below) ► See <i>Coalesse Surface Materials Reference Guide</i>.</p>

Options	U.S. Price	Required to Specify
<p>Surface Materials</p> <ul style="list-style-type: none"> • Wood • Custom wood finish 		► See <i>Coalesse Surface Materials Reference Guide</i> .
<p>Cable Management</p> <ul style="list-style-type: none"> • PDV module: black plastic 	+\$347 each	Specify with PDV module.
<p>Related Products</p> <ul style="list-style-type: none"> • Lounge chair • Sectional seating 		► Page 82 ► Page 84

Tip: One or two power, data, and voice modules are available on rectangular occasional tables.

Specification Information

Dimensions			Diameter	Style Number	U.S. Base Prices			
D	W	H			Lam 1	Lam 2	Wood 1	Wood 2

Round Occasional Tables

N.A.	N.A.	18"	20"	BTC20001	\$ 960	\$1009	\$1062	\$1111
N.A.	N.A.	18"	28"	BTC28001	\$1000	\$1051	\$1110	\$1216

Round Occasional Table with Grommet

N.A.	N.A.	18"	28"	BTC28001U	\$1065	\$1119	\$1175	\$1281
------	------	-----	-----	-----------	--------	--------	--------	--------

Square Occasional Table

24"	24"	18"	N.A.	BTC24241	\$ 986	\$1036	\$1094	\$1160
-----	-----	-----	------	----------	--------	--------	--------	--------

Square Occasional Table with Grommet

24"	24"	18"	N.A.	BTC24241U	\$1052	\$1106	\$1160	\$1226
-----	-----	-----	------	-----------	--------	--------	--------	--------

Rectangular Table

24"	48"	18"	N.A.	BTC24481	\$1595	\$1677	\$1763	\$1899
24"	72"	18"	N.A.	BTC24721	\$1635	\$1719	\$1822	\$2023

Rectangular Occasional Tables with Grommets

24"	48"	18"	N.A.	BTC24481U	\$1726	\$1814	\$1894	\$2030
24"	72"	18"	N.A.	BTC24721U	\$1766	\$1856	\$1953	\$2154

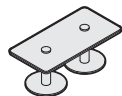
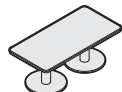

For Canadian Pricing
Multiply U.S. Price by the Canadian price factor.
► See page 1 for details.

Edge Profiles

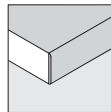

Plastic edge

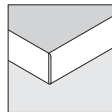

Wood edge

Bob Tables

DESIGN PEARSON LLOYD DESIGN ORIGIN: 2007 GERMANY

Tip: Glass tops are 1/2" thick, except for the absolute clear frosted glass, which is 11/16" thick. 1/32" chamfers are applied to top and bottom edges.

Standard Includes	Required to Specify
<ul style="list-style-type: none"> • Base: 8040 Aluminum Matte Polished • Top: glass • Glides 	1 Style number 2 Glass color number for top 3 Options, if selected (see below) ▶ See <i>Coalesse Surface Materials Reference Guide</i> .

Options	U.S. Price	Required to Specify
Glides <ul style="list-style-type: none"> • Felted glides 	+\$16	Specify with felted glides.

Specification Information					
Dimensions Dia H	Style Number	U.S. Base Prices			
		Top Surface: Clear Green	Clear Green Laminated/ Frosted Appearance	Absolute Clear Frosted	Absolute Clear

Round Occasional Tables

24"	15 3/4"	100-T1	\$1475	\$1611	\$1728	\$1737	\$2038
30"	15 3/4"	100-T2	\$1691	\$1826	\$2035	\$2113	\$2621
36"	15 3/4"	100-T3	\$2057	\$2220	\$2529	\$2654	\$3544
42"	15 3/4"	100-T4	\$2279	\$2510	\$2921	\$3088	\$4036

▶ Specification Information, continued on next page

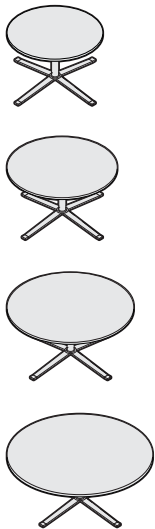

For Canadian Pricing
 Multiply U.S. Price by the
 Canadian price factor.
 ▶ See page 1 for details.

Bob Tables

DESIGN PEARSON LLOYD DESIGN ORIGIN: 2007 GERMANY

► Specification Information, continued from previous page

Specification Information

Dimensions		Style Number	U.S. Base Prices					
Dia	H		Top Surface:					
			Clear	Clear Green	Absolute Clear	Absolute Frosted	Absolute Clear	Colored Glass
			Green	Laminated/ Frosted Appearance				

Round Conference Dining Tables



24"	29"	105-T1	\$1571	\$1700	\$1819	\$1826	\$2146
-----	-----	--------	--------	--------	--------	--------	--------



30"	29"	105-T2	\$1786	\$1917	\$2123	\$2202	\$2706
-----	-----	--------	--------	--------	--------	--------	--------



36"	29"	105-T3	\$2124	\$2287	\$2596	\$2721	\$3574
-----	-----	--------	--------	--------	--------	--------	--------



42"	29"	105-T4	\$2346	\$2570	\$2982	\$3149	\$4067
-----	-----	--------	--------	--------	--------	--------	--------

 **For Canadian Pricing**
 Multiply U.S. Price by the
 Canadian price factor.
 ► See page 1 for details.

Calm Tables Square

DESIGN PAMELA LIGHT, FIIDA DESIGN ORIGIN: UNITED STATES

Tip: The Interport power/data module is not available on Calm tables.

Tip: Powder coat colors are different than other Coalesse powder coats.

Standard Includes	Required to Specify
<ul style="list-style-type: none"> • Base/frame: steel tubing and rods with decorative stainless steel cables • Cables: uncoated and located on two sides • Stretcher is located on all 4 sides • Tops: <ul style="list-style-type: none"> - Glass: 3/4" thick, green tinted with white enamel bottom surface. Translucent glass treatment does not match any existing Coalesse glass tops - Granite: 3/4" thick, available in two finishes: Black Absolute and Ubatuba (Green) • Available in Maple or Walnut veneer top with knife edge detail • Square edge detail 	1 Style number 2 Top color number 3 Frame finish Powder coat colors: - Black Gloss - Graphite Gloss - Platinum Gloss - Arctic White Gloss ▶ See <i>Coalesse Surface Materials Reference Guide</i> .

Specification Information

Dimensions			Style Number	U.S. Prices				
D	W	H		Top Surface:				
				Maple	Walnut	Glass	Black Absolute Granite	Ubatuba Granite
20"	20"	17"	72-2020L	\$1359	\$1490	\$1642	\$1748	\$2003
20"	20"	22"	72-2020H	\$1388	\$1525	\$1701	\$1808	\$2072
24"	24"	17"	72-2424L	\$1455	\$1578	\$1778	\$1933	\$2192
24"	24"	22"	72-2424H	\$1519	\$1650	\$1848	\$1932	\$2192
36"	36"	17"	72-3636L	\$2103	\$2227	\$2744	\$3227	\$3491
42"	42"	17"	72-4242L	\$2192	\$2324	\$3225	\$4649	\$4909

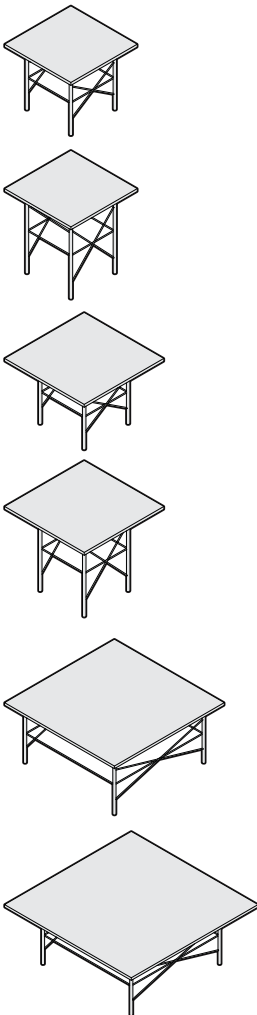

Calm Tables Oval

DESIGN PAMELA LIGHT, FIIDA DESIGN ORIGIN: UNITED STATES

Tip: The Interport power/data module is not available on Calm tables.

Tip: Powder coat colors are different than other Coalesse powder coats.

Standard Includes	Required to Specify
-------------------	---------------------

- | | |
|--|--|
| <ul style="list-style-type: none"> Base/frame: steel tubing and rods with decorative stainless steel cables Cables: uncoated and located on two sides Stretcher is located on all 4 sides Tops: <ul style="list-style-type: none"> - Glass: 3/4" thick, green tinted with white enamel bottom surface. Translucent glass treatment does not match any existing Coalesse glass tops - Granite: 3/4" thick, available in two finishes: Black Absolute and Ubatuba (Green) Available in Maple or Walnut veneer top with knife edge detail Square edge detail | <ol style="list-style-type: none"> 1 Style number 2 Top color number 3 Frame finish <ul style="list-style-type: none"> - Powder coat colors: <ul style="list-style-type: none"> - Black Gloss - Graphite Gloss - Platinum Gloss - Arctic White Gloss <p>▶ See <i>Coalesse Surface Materials Reference Guide</i>.</p> |
|--|--|

Specification Information									
---------------------------	--	--	--	--	--	--	--	--	--

Dimensions			Style Number	U.S. Prices				
D	W	H		Top Surface:				
				Maple	Walnut	Glass	Black Absolute Granite	Ubatuba Granite
20"	26"	17"	72-2026LV	\$1607	\$1744	\$1854	\$2599	\$2860
20"	26"	22"	72-2026HV	\$1678	\$1802	\$1988	\$2664	\$2924
22"	42"	17"	72-2242LV	\$1956	\$2088	\$2461	\$3269	\$3522



For Canadian Pricing
 Multiply U.S. Price by the Canadian price factor.
 ▶ See page 1 for details.

Calm Tables Rectangle

DESIGN PAMELA LIGHT, FIIDA DESIGN ORIGIN: UNITED STATES

Tip: The Interport power/data module is not available on Calm tables.

Tip: Powder coat colors are different than other Coalesse powder coats.

Standard Includes	Required to Specify
-------------------	---------------------

- | | |
|--|---|
| <ul style="list-style-type: none"> • Base/frame: steel tubing and rods with decorative stainless steel cables • Cables: uncoated and located on two sides • Stretcher is located on all 4 sides • Tops: <ul style="list-style-type: none"> - Glass: 3/4" thick, green tinted with white enamel bottom surface. Translucent glass treatment does not match any existing Coalesse glass tops - Granite: 3/4" thick, available in two finishes: Black Absolute and Ubatuba (Green) • Available in Maple or Walnut veneer top with knife edge detail • Square edge detail | <ol style="list-style-type: none"> 1 Style number 2 Top color number 3 Frame finish <ul style="list-style-type: none"> - Black Gloss - Graphite Gloss - Platinum Gloss - Arctic White Gloss <p>▶ See <i>Coalesse Surface Materials Reference Guide</i>.</p> |
|--|---|

Specification Information									
---------------------------	--	--	--	--	--	--	--	--	--

Dimensions			Style Number	U.S. Prices					
D	W	H		Top Surface:					
				Maple	Walnut	Glass	Black Absolute Granite	Ubatuba Granite	
20"	26"	17"	72-2026LR	\$1436	\$1559	\$1769	\$1803		\$2067
20"	26"	22"	72-2026HR	\$1465	\$1589	\$1840	\$1879		\$2134
20"	38"	17"	72-2038LR	\$1732	\$1863	\$2051	\$2464		\$2724
21"	42"	17"	72-2142LR	\$1932	\$2069	\$2275	\$2777		\$3037

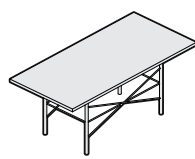
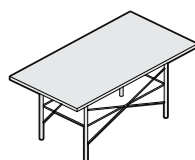
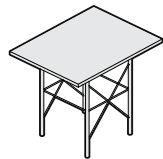
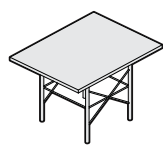

For Canadian Pricing
 Multiply U.S. Price by the Canadian price factor.
 ▶ See page 1 for details.

Coalesse

Calm Tables Rectangle

DESIGN PAMELA LIGHT, FIIDA DESIGN ORIGIN: UNITED STATES

Standard Includes	Required to Specify
<ul style="list-style-type: none"> • Frame/legs: painted aluminum • Tops <ul style="list-style-type: none"> - Laminate: 1/2" thick top - Wood: veneer, oak, or walnut 1/2" thick top - Solid surface: 1/2" thick top: Glacier White only - Back painted glass: 1/2" thick top • Leg inserts: <ul style="list-style-type: none"> - Solid surface, 1/4" thick - Hardwood, 1/4" thick • Glides: non-adjustable, ships with felt option 	<ol style="list-style-type: none"> 1 Style number 2 Metal color number for frame/leg <ul style="list-style-type: none"> 4141 Platinum Matte 4180 Graphite Matte 4193 Midnight Brown Matte 4242 Milk Matte 4710 Black Matte 3 Color or finish number for top selection 4 Leg insert finish in solid surface or hardwood oak or walnut 5 Options, if selected (see below) <ul style="list-style-type: none"> ▶ See <i>Coalesse Surface Materials Reference Guide</i>.

Specification Information

Dimensions			Style Number	U.S. Prices				
D	W	H		Top Surface:				
				Laminate	Veneer Grade 1	Veneer Grade 2	White Solid Surface	Back Painted Glass

Low Square Tables

36"	36"	14"	COCGM3636L	\$1561	\$1853	\$2068	\$2376	\$2558
42"	42"	14"	COCGM4242L	\$1769	\$2102	\$2348	\$2714	\$2906
60"	60"	14"	COCGM6060L	\$2341	\$2913	\$3121	N.A.	N.A.

Low Rectangular Tables

18"	36"	14"	COCGM1836L	\$1332	\$1598	\$1798	\$2070	\$2237
18"	42"	14"	COCGM1842L	\$1405	\$1686	\$1890	\$2204	\$2360

▶ Specification Information, continued on next page

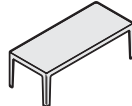
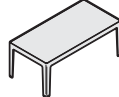
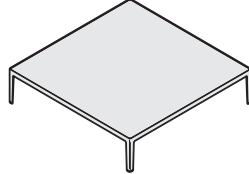
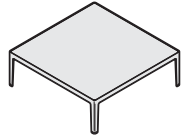
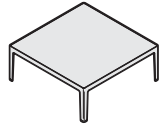

 **For Canadian Pricing**
 Multiply U.S. Price by the Canadian price factor.
 ▶ See page 1 for details.

► Specification Information, continued from previous page

Specification Information

Dimensions			Style Number	U.S. Prices				
D	W	H		Top Surface:				
				Laminate	Veneer Grade 1	Veneer Grade 2	White Solid Surface	Back Painted Glass

High Square Tables

20"	20"	19"	COCGM2020H	\$1248	\$1498	\$1685	\$1966	\$2132
-----	-----	-----	------------	--------	--------	--------	--------	--------



24"	24"	19"	COCGM2424H	\$1363	\$1635	\$1839	\$2135	\$2291
-----	-----	-----	------------	--------	--------	--------	--------	--------



High Rectangular Table

24"	36"	19"	COCGM2436H	\$1446	\$1736	\$1950	\$2295	\$2430
-----	-----	-----	------------	--------	--------	--------	--------	--------

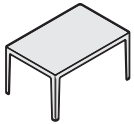

For Canadian Pricing
 Multiply U.S. Price by the
 Canadian price factor.
 ► See page 1 for details.

Standard Includes	Required to Specify
<ul style="list-style-type: none"> • Frame/legs: hardwood oak • Tops <ul style="list-style-type: none"> - Laminate: 1/2" thick top - Wood: veneer, oak, or walnut 1/2" thick top - Solid surface: 1/2" thick top: Glacier White only - Back painted glass: 1/2" thick top • Leg inserts: solid surface, 1/4" thick • Glides: non-adjustable, ships with felt option 	<ol style="list-style-type: none"> 1 Style number 2 Wood color number for frame/legs ▶ See <i>Coalesse Surface Materials Reference Guide</i>. 3 Color or finish number for top selection 4 Leg insert finish: <ul style="list-style-type: none"> 2801 Glacier White 2010 Black 2011 Midnight Brown 2012 Blue 2013 Red 5 Options, if selected (see below) ▶ See <i>Coalesse Surface Materials Reference Guide</i>.

Options	U.S. Price	Required to Specify
Surface Materials Frame/legs <ul style="list-style-type: none"> • Walnut 	+\$156	Specify with <i>frame/leg</i> in <i>walnut</i> and select finish number.

Specification Information								
Dimensions			Style Number	U.S. Base Prices				
D	W	H		Top Surface:				
				Laminate	Veneer Grade 1	Veneer Grade 2	White Solid Surface	Back Painted Glass

Low Square Tables

36"	36"	14"	COCGW3636L	\$1717	\$2061	\$2225	\$2653	\$2757
-----	-----	-----	------------	--------	--------	--------	--------	--------

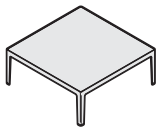

42"	42"	14"	COCGW4242L	\$1831	\$2195	\$2371	\$2861	\$2975
-----	-----	-----	------------	--------	--------	--------	--------	--------

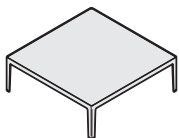

Low Rectangular Tables

18"	36"	14"	COCGW1836L	\$1509	\$1811	\$1956	\$2352	\$2425
-----	-----	-----	------------	--------	--------	--------	--------	--------

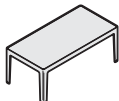

18"	42"	14"	COCGW1842L	\$1665	\$1998	\$2158	\$2601	\$2705
-----	-----	-----	------------	--------	--------	--------	--------	--------

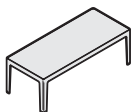

▶ Specification Information, continued on next page



For Canadian Pricing
 Multiply U.S. Price by the Canadian price factor.
 ▶ See page 1 for details.

► Specification Information, continued from previous page

Specification Information

Dimensions			Style Number	U.S. Base Prices				
D	W	H		Top Surface:				
				Laminate	Veneer Grade 1	Veneer Grade 2	White Solid Surface	Back Painted Glass

High Square Tables

20"	20"	19"	COCGW2020H	\$1353	\$1623	\$1754	\$2009	\$2154
-----	-----	-----	------------	--------	--------	--------	--------	--------

24"	24"	19"	COCGW2424H	\$1457	\$1749	\$1887	\$2160	\$2316
-----	-----	-----	------------	--------	--------	--------	--------	--------

High Rectangular Table

24"	36"	19"	COCGW2436H	\$1613	\$1935	\$2090	\$2502	\$2700
-----	-----	-----	------------	--------	--------	--------	--------	--------

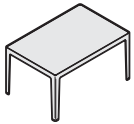
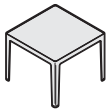

For Canadian Pricing
 Multiply U.S. Price by the Canadian price factor.
 ► See page 1 for details.

CH008 Sofa Table

DESIGN HANS WEGNER DESIGN ORIGIN: DENMARK, 1954

Tip: Your specification is not complete until you add the height suffix.



Overall: 30"Dia. 17½"H or 20⅝"H



Overall: 34½"Dia. 17½"H or 20⅝"H



Overall: 39¼"Dia. 17½"H or 20⅝"H

Standard Includes	Required to Specify
-------------------	---------------------

- Table: wood

- 1 Style number
- 2 Wood species/finish number, (See matrix below)
- 3 Table height:
 - 17½"H
 - 20⅝"H

Specification Information	
Style Number	U.S. Price

30" Round Sofa Table

CH008078OAK	\$3741
CH008078ASH	\$3357
CH008078WAL	\$4088

34½" Round Sofa Table

CH008088OAK	\$3998
CH008088ASH	\$3555
CH008088WAL	\$4383

39¼" Round Sofa Table

CH0080100OAK	\$4484
CH0080100ASH	\$3969
CH0080100WAL	\$4957

Wood Species/Finish Number Matrix			
Finish	Wood Species Number:		
	Oak	Ash	Walnut

Lacquer	3255	3615	3325
White Oil	3265	3645	N.A.
Oil	N.A.	N.A.	3335



For Canadian Pricing
 Multiply U.S. Price by the Canadian price factor.
 ▶ See page 1 for details.

Coalesse

CH100 Series Glass Coffee Table

DESIGN HANS WEGNER DESIGN ORIGIN: DENMARK, 1970

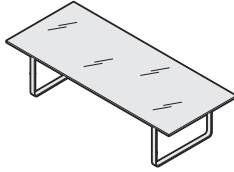

Overall: 27½"D 67"W 16½"H

Standard Includes

- Stainless steel frame and hardware
- 9208 Chrome, etched finish
- 6513 Clear glass

Required to Specify

Style number

Specification Information

Style Number	U.S. Price
CH108	\$6572



For Canadian Pricing
Multiply U.S. Price by the
Canadian price factor.
▶ See page 1 for details.

Coalesse

CH327 Dining Table

DESIGN HANS WEGNER DESIGN ORIGIN: DENMARK, 1954

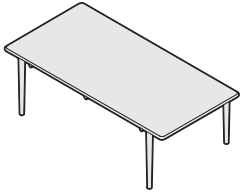

Overall: 75"L 37½"W 28½"H

Standard Includes

- Table: wood

Required to Specify

- 1 Style number
- 2 Wood species/finish number,
(See matrix below)

Specification Information

Style Number	U.S. Price
--------------	------------

CH327OAK	\$8925
----------	--------

CH327ASH	\$8008
----------	--------

CH327WALNUT	\$9478
-------------	--------

Wood Species/Finish Number Matrix

Finish	Wood Species Number:		
	Oak	Ash	Walnut
Lacquer	3255	3615	3325
White Oil	3265	3645	N.A.
Oil	N.A.	N.A.	3335



For Canadian Pricing
Multiply U.S. Price by the
Canadian price factor.
▶ See page 1 for details.

Circa Freestanding Tables

DESIGN ALISON SPEAR, AIA DESIGN ORIGIN: UNITED STATES

Tip: Optional steel leg has a 90° corner tapered shape.

Tip: Galvanized aluminum liner is not water tight, plastic liner recommended.

Tip: Please submit sketch for modular applications.

Tip: These colors are different than other Coalesse powder coats.

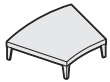

Overall: 29½"D 36⅝"W 8½"H

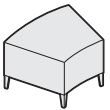

Overall: 29"D 36⅞"W 22½"H

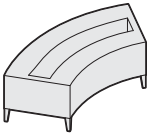

Overall: 33¼"D 70¾"W 22½"H

Standard Includes	Required to Specify
<ul style="list-style-type: none"> • Frame: hardwood veneered panels • Top and legs: hardwood maple or walnut • Planter: galvanized aluminum 	1 Style number 2 Wood color number for legs and frame 3 Options, if selected (see below) ▶ See <i>Coalesse Surface Materials Reference Guide</i> .

Options	U.S. Price	Required to Specify
Metal Legs <ul style="list-style-type: none"> • Powder coat steel legs 	+\$124 per leg	Specify with <i>powder coat steel legs</i> and specify color number: Graphite Gloss, Arctic White Gloss, Platinum Gloss, Black Gloss, Midnight Brown Gloss.

Specification Information

Style Number	U.S. Base Price
--------------	-----------------

30° Freestanding Low Table with Four Legs

45-T3730L	\$1787
-----------	--------

30° Freestanding High Table with Four Legs

45-T3730H	\$2395
-----------	--------

60° Freestanding Table-Planter with Five Legs

45-T7460HP	\$4767
------------	--------



For Canadian Pricing
 Multiply U.S. Price by the Canadian price factor.
 ▶ See page 1 for details.

Circa Freestanding Tables

DESIGN ALISON SPEAR, AIA DESIGN ORIGIN: UNITED STATES

Tip: Optional steel leg has a 90° corner tapered shape.

Tip: Please submit sketch for modular applications.

Tip: These colors are different than other Coalesse powder coats.

Standard Includes		Required to Specify	
	<ul style="list-style-type: none"> • Frame: hardwood veneered panels • Top and legs: hardwood maple or walnut 		1 Style number 2 Wood color number for legs and frame ▶ See <i>Coalesse Surface Materials Reference Guide</i> . 3 Options, if selected (see below) ▶ See <i>Coalesse Surface Materials Reference Guide</i> .
Options		U.S. Price	Required to Specify
Glass Insert	<ul style="list-style-type: none"> • Green tinted glass insert for round table 3/4" thick with white enamel bottom square edge detail 	+\$232	Specify with <i>glass insert</i> .
Metal Legs	<ul style="list-style-type: none"> • Powder coat steel legs 	+\$124 per leg	Specify with <i>powder coat steel legs</i> and specify color number: Graphite Gloss, Arctic White Gloss, Platinum Gloss, Black Gloss, Midnight Brown Gloss.
Power/Data Module (45-T42RD only)	<ul style="list-style-type: none"> • Two power/two data ports for round table only matte black or silver mica 	+\$343	Specify finish color number.

Specification Information		
Style Number	U.S. Base Prices	
	Walnut or Maple	Sunburst Top

Freestanding Round Table

45-T42RD	\$3234	\$3484
----------	--------	--------

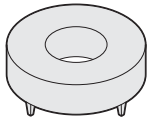

Overall: 42" dia. 15 3/4"H

Freestanding High Wedge Table

45-T1815H	\$1936	N.A.
-----------	--------	------

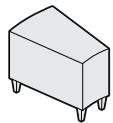

Overall: 28"D 18 1/2"W 22 1/2"H
Angle Degree: 15°

Freestanding High Straight Table

45-T1300H	\$2283	N.A.
-----------	--------	------

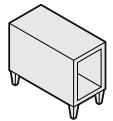

Overall: 27 1/2"D 13 1/2"W 22 1/2"H
Angle Degree: 0°

Freestanding Low Straight Table

45-T1300L	\$1495	N.A.
-----------	--------	------

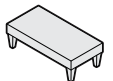

Overall: 27 1/2"D 13 1/2"W 8 1/2"H
Angle Degree: 0°

Freestanding Low Wedge Table

45-T1815L	\$1495	N.A.
-----------	--------	------

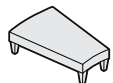

Overall: 28"D 18 1/2"W 8 1/2"H
Angle Degree: 15°



For Canadian Pricing
 Multiply U.S. Price by the Canadian price factor.
 ▶ See page 1 for details.

Denizen Collection Tablet Table

DESIGN WILLIAMS SOREL DESIGN ORIGIN: 2008 UNITED STATES



Tip: Ships assembled.

Standard Includes	Required to Specify
<ul style="list-style-type: none"> • Top: V3AK Rift Cut Oak veneer • Column with default painted base: paint (see below) • Glides: nylon non-marring 	<ol style="list-style-type: none"> 1 Style number 2 Wood finish for top <p>► See <i>Coalesse Surface Materials Reference Guide</i>.</p> <ol style="list-style-type: none"> 3 Paint finish for column 4 Options, if selected (see below)

Options	U.S. Price	Required to Specify
Surface Materials Top <ul style="list-style-type: none"> • V2AA Quarter Cut Grey Ash • V2AT Quarter Cut Teak 	Prices below Prices below	Specify <i>with grey ash</i> . Specify <i>with teak</i> .
Column <ul style="list-style-type: none"> • Brushed nickel 	+\$108	Specify <i>with brushed nickel column</i> .

Specification Information

Dimensions			Style Number	U.S. Base Prices		
D	W	H		Finishes:		
				Oak	Ash	Teak

Tablet Table

16"	35"	26"	CODT163526	\$1766	\$1818	\$2026
-----	-----	-----	------------	--------	--------	--------

Base Default

Column Paint	Base Default
4138 Graphite Gloss	Graphite Metallic
4142 Platinum Gloss	Graphite Metallic
4144 Black Gloss	Graphite Metallic
4145 Milk Gloss	Gun Metal Matte
4147 Champagne Gloss	Gun Metal Matte
9238 Brushed Nickel	Gun Metal Matte



For Canadian Pricing
 Multiply U.S. Price by the Canadian price factor.
 ► See page 1 for details.

Denizen Collection Console Table

DESIGN WILLIAMS SOREL DESIGN ORIGIN: 2009 UNITED STATES

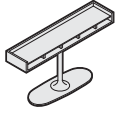

Tip: Ships assembled.

Tip: Bento box may be ordered separately.

Standard Includes	Required to Specify
<ul style="list-style-type: none"> • Top: V3AK Rift Cut Oak veneer • Column with default painted base: paint (see below) • Glides: non-marring 	<ol style="list-style-type: none"> 1 Style number 2 Wood finish for top ▶ See <i>Coalesse Surface Materials Reference Guide</i>. 3 Paint finish for column 4 Options, if selected (see below) ▶ See <i>Coalesse Surface Materials Reference Guide</i>.

	Options	U.S. Price	Required to Specify
Surface Materials	Top		
	<ul style="list-style-type: none"> • V2AA Quarter Cut Grey Ash • V2AT Quarter Cut Teak 	Prices below Prices below	Specify <i>with grey ash</i> . Specify <i>with teak</i> .
	Column		
	<ul style="list-style-type: none"> • Brushed nickel 	+\$108	Specify <i>with brushed nickel column</i> .
Storage	<ul style="list-style-type: none"> • Bento box 	+\$215	Specify <i>with bento box</i> .

Specification Information						
Dimensions			Style Number	U.S. Base Prices		
D	W	H		Finishes:		
				Oak	Ash	Teak

Console Table

14"	52"	32 1/4"	CODC145231	\$3201	\$3295	\$3671
-----	-----	---------	------------	--------	--------	--------

Base Default	
Column Paint	Base Default
4138 Graphite Gloss	Graphite Metallic
4142 Platinum Gloss	Graphite Metallic
4144 Black Gloss	Graphite Metallic
4145 Milk Gloss	Gun Metal Matte
4147 Champagne Gloss	Gun Metal Matte
9238 Brushed Nickel	Gun Metal Matte



For Canadian Pricing
 Multiply U.S. Price by the Canadian price factor.
 ▶ See page 1 for details.

Diekman

DESIGN NORMAN DIEKMAN DESIGN ORIGIN: UNITED STATES

Tip: Interport power/data module is not available on Diekman.

Standard Includes	Required to Specify
<ul style="list-style-type: none"> • Frame/top: hard maple veneer • Glass top models: <ul style="list-style-type: none"> - 47-T17ELG and 47-T17RG1 models consist of two Diekman wood bases (47-T2617D and 47T2217E) with elliptical or rectangular glass tops - 1/2" thick clear glass top with radiused corners • Glides: polyethylene, non-adjustable 	1 Style number 2 Top color number 3 Frame finish ▶ See <i>Coalesse Surface Materials Reference Guide</i> .

Specification Information

Dimensions			Style Number	U.S. Prices		
D	W	H		Top Surface:		
					Glass	Wood

Wood

9 1/4"	13"	26"	47-T1326C	N.A.	\$1389
10"	16"	23"	47-T1623A	N.A.	\$1322
10"	16"	23"	47-T1623B	N.A.	\$1322
13 1/2"	15 3/4"	23"	47-T23EL	N.A.	\$1347
16"	25 3/4"	17"	47-T2617D	N.A.	\$1492
14 1/2"	22 1/4"	17"	47-T2217E	N.A.	\$1467

Wood Base, Elliptical Top

32"	40"	17 3/4"	47-T17ELG	\$3371	N.A.
-----	-----	---------	-----------	--------	------

Wood Base, Rectangle Top

32"	40"	17 3/4"	47-T17RG1	\$3386	N.A.
-----	-----	---------	-----------	--------	------

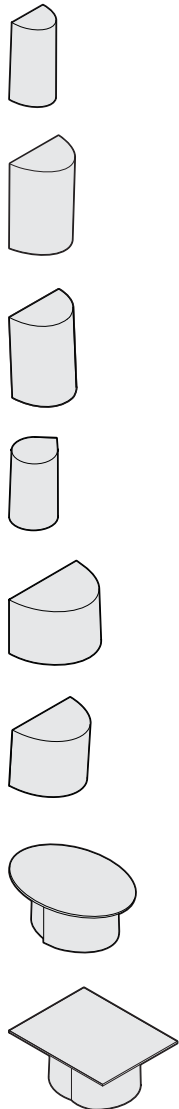

Donovan

DESIGN GEORGE SIMONS, IDSA DESIGN ORIGIN: UNITED STATES

Tip: Granite is a natural material, and fissures, color, and vein patterns will be inherent.

Tip: Granite tops are crated separately for maximum protection and shipped vertically.

Tip: Bases are not sold separately.

Tip: Contrasting wood top option is available on wood models only.

Tip: Interport not available on 36-1943EL.

► See *Interport power/data module*, page 370.

Tip: Specify position of module; centered or off-centered, and provide a sketch.

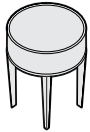

Overall: 18" Dia. 22"H

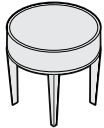

Overall: 24" Dia. 22"H



Overall: 24" Dia. 17"H



Overall: 31" Dia. 17"H



For Canadian Pricing
Multiply U.S. Price by the Canadian price factor.

► See page 1 for details.

Standard Includes	Required to Specify
<ul style="list-style-type: none"> • Frame: solid maple and maple veneered frame • Tops: <ul style="list-style-type: none"> - Glass: 3/4" thick, green tinted with white enamel bottom - Finesse: 3/4" thick, with Finesse applied - Wood: 3/4" thick, selected maple veneer - Granite: 3/4" thick, available in two finishes: Black Absolute or Ubatuba (Green) • Glides: Polyethylene 	1 Style number 2 Wood color number for frame ► See <i>Coalesse Surface Materials Reference Guide</i> . 3 Frame finish 4 Options, if selected (see below) ► See <i>Coalesse Surface Materials Reference Guide</i> .

Options	U.S. Price	Required to Specify
Surface Materials <ul style="list-style-type: none"> • Contrasting wood top 	+\$174	Specify with <i>contrasting wood top</i> .
Interport Power/Data Module <ul style="list-style-type: none"> • Available on wood or Finesse tops 	+\$306	Specify with <i>Interport</i> and select finish color number.

Specification Information					
Style Number	U.S. Base Prices				
	Top Surface:				
	Finesse	Glass	Wood	Black Absolute Granite	Ubatuba Granite

Round					
36-18RDHF	\$1354	N.A.	N.A.	N.A.	N.A.
36-18RDHGL	N.A.	\$1748	N.A.	N.A.	N.A.
36-18RDHW	N.A.	N.A.	\$1465	N.A.	N.A.
36-18RDHGR	N.A.	N.A.	N.A.	\$1732	\$1743
36-24RDHF	\$1607	N.A.	N.A.	N.A.	N.A.
36-24RDHGL	N.A.	\$2099	N.A.	N.A.	N.A.
36-24RDHW	N.A.	N.A.	\$1684	N.A.	N.A.
36-24RDHGR	N.A.	N.A.	N.A.	\$2393	\$2455
36-24RDLF	\$1572	N.A.	N.A.	N.A.	N.A.
36-24RDLGL	N.A.	\$2056	N.A.	N.A.	N.A.
36-24RDLW	N.A.	N.A.	\$1649	N.A.	N.A.
36-24RDLGR	N.A.	N.A.	N.A.	\$2352	\$2409
36-31RDLF	\$1992	N.A.	N.A.	N.A.	N.A.
36-31RDLGL	N.A.	\$2651	N.A.	N.A.	N.A.
36-31RDLW	N.A.	N.A.	\$2110	N.A.	N.A.
36-31RDLGR	N.A.	N.A.	N.A.	\$3976	\$4141

► Specification Information, continued on next page

Donovan

DESIGN GEORGE SIMONS, IDSA DESIGN ORIGIN: UNITED STATES

► Specification Information, continued from previous page

Specification Information

Style Number	U.S. Base Prices				
	Top Surface:				
	Finesse	Glass	Wood	Black Absolute Granite	Ubatuba Granite

Elliptical

36-1943ELF	\$2134	N.A.	N.A.	N.A.	N.A.
36-1943ELGL	N.A.	\$2965	N.A.	N.A.	N.A.
36-1943ELW	N.A.	N.A.	\$2346	N.A.	N.A.
36-1943ELGR	N.A.	N.A.	N.A.	\$4006	\$4143

Square

36-1818HF	\$1354	N.A.	N.A.	N.A.	N.A.
36-1818HGL	N.A.	\$1748	N.A.	N.A.	N.A.
36-1818HW	N.A.	N.A.	\$1465	N.A.	N.A.
36-1818HGR	N.A.	N.A.	N.A.	\$1732	\$1743
36-2424HF	\$1607	N.A.	N.A.	N.A.	N.A.
36-2424HGL	N.A.	\$2099	N.A.	N.A.	N.A.
36-2424HW	N.A.	N.A.	\$1684	N.A.	N.A.
36-2424HGR	N.A.	N.A.	N.A.	\$2393	\$2455
36-2424LF	\$1572	N.A.	N.A.	N.A.	N.A.
36-2424LGL	N.A.	\$2056	N.A.	N.A.	N.A.
36-2424LW	N.A.	N.A.	\$1649	N.A.	N.A.
36-2424LGR	N.A.	N.A.	N.A.	\$2352	\$2409



Overall: 19½"D 43"W 17"H

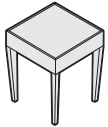

Overall: 18"D 18"W 22"H

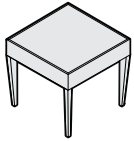

Overall: 24"D 24"W 22"H

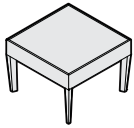

Overall: 24"D 24"W 17"H



For Canadian Pricing
 Multiply U.S. Price by the
 Canadian price factor.
 ► See page 1 for details.

Enea Tables Single Base

DESIGN JOSEP LLUSCA DESIGN ORIGIN: SPAIN

 = Available in Rapid10.

Tip: Shipped knocked down.

Tip: Disc bases are 24" diameter for 30", 36", and 42" diameter tables. Disc bases are 31 1/2" diameter for 54" and 60" diameter tables.

Tip: White laminate tops may exhibit slightly visible black specks inherent to the top manufacturing process.

Standard Includes Required to Specify

- Laminate top: 3/4" thick with T-molding color matched to base (silver metallic, black, or white)
- Wood top: 3/4" thick with maple edge and maple veneer
- Base/frame: steel tubing and base
- Glides: non-skid

- 1 Style number
- 2 Laminate or wood top color number:
For laminate:
2730 Arctic White
2746 Black
2884 Milk
2890 Folkstone
2891 Ingot
2892 Ash
For wood:
▶ See *Coalesse Surface Materials Reference Guide*.
- 3 Base/frame finish: black gloss, white gloss or silver metallic
▶ See *Coalesse Surface Materials Reference Guide*.

Specification Information

Dimensions Diameter H	Style Number	U.S. Prices	
		Top Surface: Laminate	Wood

Occasional

36"	18"	H35-T3618L	\$ 880	N.A.
36"	18"	H35-T3618W	N.A.	\$1217
42"	18"	H35-T4218L	\$1059	N.A.
42"	18"	H35-T4218W	N.A.	\$1740

Conference

30"	30"	H35-T3030L	\$1035	N.A.
30"	30"	H35-T3030W	N.A.	\$1614
36"	30"	H35-T3630L	\$1090	N.A.
36"	30"	H35-T3630W	N.A.	\$1795
 42"	30"	H35-T4230L	\$1253	N.A.
42"	30"	H35-T4230W	N.A.	\$1939
54"	30"	H35-T5430L	\$1993	N.A.
54"	30"	H35-T5430W	N.A.	\$3143
60"	30"	H35-T6030L	\$1996	N.A.
60"	30"	H35-T6030W	N.A.	\$3406

▶ Specification Information, continued on next page

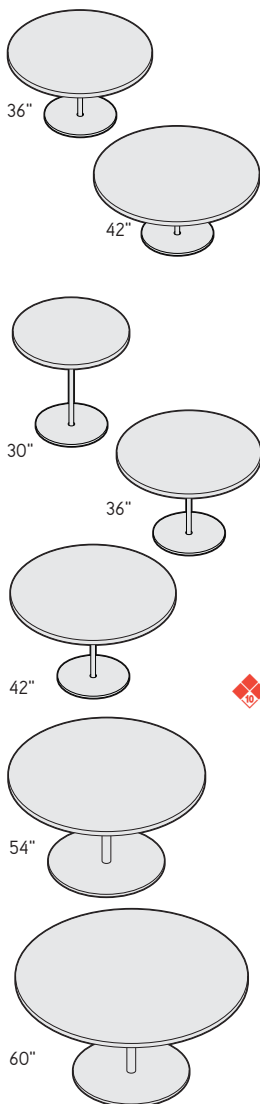

Enea Tables Single Base

DESIGN JOSEP LLUSCA DESIGN ORIGIN: SPAIN

 = Available in Rapid10.

► Specification Information, continued from previous page

Specification Information

Dimensions		Style Number	U.S. Prices	
Diameter	H		Top Surface: Laminate	Wood

Café/Counter Height

24"	36"	H35-T2436L	\$1000	N.A.
24"	36"	H35-T2436W	N.A.	\$1626

30"	36"	H35-T3036L	\$1093	N.A.
30"	36"	H35-T3036W	N.A.	\$1819

36"	36"	H35-T3636L	\$1132	N.A.
36"	36"	H35-T3636W	N.A.	\$1982

42"	36"	H35-T4236L	\$1307	N.A.
42"	36"	H35-T4236W	N.A.	\$2644

Café/Bar Height

24"	42"	H35-T2442L	\$1030	N.A.
24"	42"	H35-T2442W	N.A.	\$1669

 30"	42"	H35-T3042L	\$1104	N.A.
30"	42"	H35-T3042W	N.A.	\$1868

 36"	42"	H35-T3642L	\$1139	N.A.
36"	42"	H35-T3642W	N.A.	\$2030

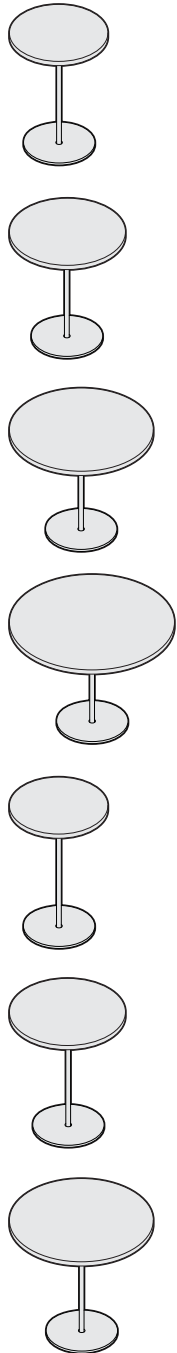

Enea Tables Twin Base

DESIGN JOSEP LLUSCA DESIGN ORIGIN: SPAIN

Tip: Shipped knocked down.

Tip: Due to weight of steel bases, please lift or move tables by bases only (do not lift by tops) with at least two people.

Tip: White laminate tops may exhibit slightly visible black specks inherent to the top manufacturing process.

Standard Includes	Required to Specify
<ul style="list-style-type: none"> • Base/frame: steel tubing and base • Glides: non-skid • Disc bases are 24" diameter • Laminate top: 3/4" thick with T-molding color matched to base (silver metallic, black, or white) • Wood top: 3/4" thick with maple edge and maple veneer 	<ol style="list-style-type: none"> 1 Style number 2 Base/frame finish: black gloss, white gloss or silver metallic 3 Laminate or wood top color number: For laminate: 2730 Arctic White 2746 Black 2884 Milk 2890 Folkstone 2891 Ingot 2892 Ash For wood: ▶ See <i>Coalesse Surface Materials Reference Guide</i>. 4 Options, if selected (see below) ▶ See <i>Coalesse Surface Materials Reference Guide</i>.

Options	U.S. Price	Required to Specify
Interport Power/Data Module <ul style="list-style-type: none"> • Mho power/data module (available in clear anodized aluminum) 	+\$306	Specify with <i>Mho power/data module</i> .

Specification Information						
Dimensions			Style Number	U.S. Base Prices		
D	W	H		Top Surface:		
				Laminate	Wood	

Rectangular						
30"	72"	30"	H35-T307230GL	\$2571	N.A.	
30"	72"	30"	H35-T307230GW	N.A.	\$3631	
30"	72"	36"	H35-T307236GL	\$2698	N.A.	
30"	72"	36"	H35-T307236GW	N.A.	\$3752	
30"	72"	42"	H35-T307242GL	\$2980	N.A.	
30"	72"	42"	H35-T307242GW	N.A.	\$3885	

▶ Specification Information, continued on next page

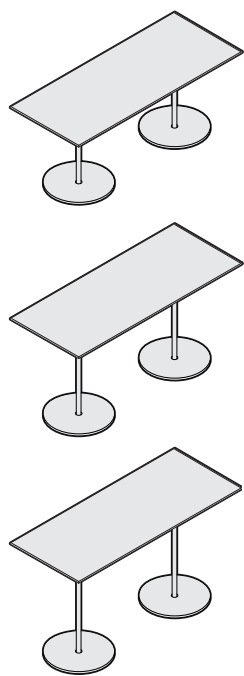

 **For Canadian Pricing**
 Multiply U.S. Price by the Canadian price factor.
 ▶ See page 1 for details.

Enea Tables Twin Base

DESIGN JOSEP LLUSCA DESIGN ORIGIN: SPAIN

► Specification Information, continued from previous page

Specification Information

Dimensions			Style Number	U.S. Base Prices	
D	W	H		Top Surface:	Wood

Oval

30"	72"	30"	H35-T307230VL	\$2565	N.A.
30"	72"	30"	H35-T307230VW	N.A.	\$3740

30"	72"	36"	H35-T307236VL	\$2585	N.A.
30"	72"	36"	H35-T307236VW	N.A.	\$3854

30"	72"	42"	H35-T307242VL	\$2824	N.A.
30"	72"	42"	H35-T307242VW	N.A.	\$3957

Conference/Racetrack

30"	72"	30"	H35-T307230KL	\$2590	N.A.
30"	72"	30"	H35-T307230KW	N.A.	\$3782

Counter/Racetrack

30"	72"	36"	H35-T307236KL	\$2704	N.A.
30"	72"	36"	H35-T307236KW	N.A.	\$3878

Café/Racetrack

30"	72"	42"	H35-T307242KL	\$2861	N.A.
30"	72"	42"	H35-T307242KW	N.A.	\$4011

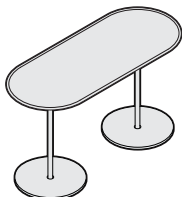
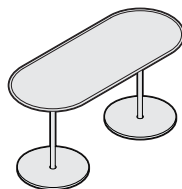
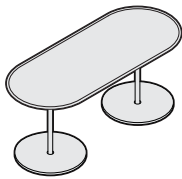
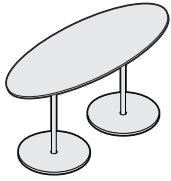
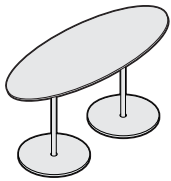
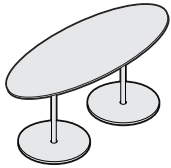

Mho Power Module for Enea Twin Base Tables

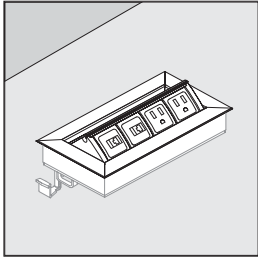
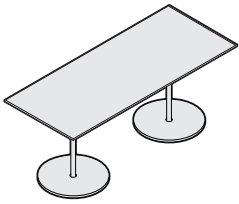

Available Models: **Options:** Available on wood, laminate and finesse covered tops only. Available in centered position only. Mho not available on Coalesse and CoalesseSpaces.models. Check grid for model availability.

Table	Model	Centered	Off Center
Enea	H35-T307230GL	Yes	No
	H35-T307230GW	Yes	No
	H35-T307236GL	Yes	No
	H35-T307236GW	Yes	No
	H35-T307242GL	Yes	No
	H35-T307242GW	Yes	No
	H35-T307230VL	Yes	No
	H35-T307230VW	Yes	No
	H35-T307236VL	Yes	No
	H35-T307236VW	Yes	No
	H35-T307242VL	Yes	No
	H35-T307242VW	Yes	No
	H35-T307230KL	Yes	No
	H35-T307230KW	Yes	No
	H35-T307236KL	Yes	No
	H35-T307236KW	Yes	No
	H35-T307242KL	Yes	No
	H35-T307242KW	Yes	No

Color:
Anodized Aluminum

Enea Lottus Occasional Tables

DESIGN LIEVORE ALTHERR MOLINA DESIGN ORIGIN: SPAIN

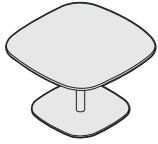

Standard Includes

- Top: laminate or wood veneer with 1/2" thick phenolic core
- Base and frame: steel tubing and base
- Glides: non-skid

Required to Specify

- 1 Style number
- 2 Laminate or wood veneer color number for top
▶ See *Coalesse Surface Materials Reference Guide*.
- 3 Base/frame finish:
4016 White Gloss
4017 Black Gloss
4217 Brown
4218 Platinum Silver
▶ See *Coalesse Surface Materials Reference Guide*.

Specification Information

Dimensions			Style Number	U.S. Prices		
D	W	H		Top Surface:		
				Laminate	Wood 1	Wood 2
30"	30"	18"	COEL1830	\$1169	\$1307	\$1411
36"	36"	18"	COEL1836	\$1357	\$1524	\$1648
42"	42"	18"	COEL1842	\$1654	\$1807	\$1952



For Canadian Pricing
 Multiply U.S. Price by the
 Canadian price factor.
 ▶ See page 1 for details.

Enea Lottus Conference Tables

DESIGN LIEVORE ALTHERR MOLINA DESIGN ORIGIN: SPAIN



Standard Includes	Required to Specify
-------------------	---------------------

- Top: laminate or wood veneer with 1/2" thick phenolic core
- Base and frame: steel tubing and base
- Glides: non-skid

- 1 Style number
- 2 Laminate or wood veneer color number for top
▶ See *Coalesse Surface Materials Reference Guide*.
- 3 Base/frame finish:
4016 White Gloss
4017 Black Gloss
4217 Brown
4218 Platinum Silver
▶ See *Coalesse Surface Materials Reference Guide*.

Specification Information						
Dimensions			Style Number	U.S. Prices		
D	W	H		Top Surface:		
				Laminate	Wood 1	Wood 2
30"	30"	30"	COEL3030	\$1220	\$1358	\$1466
36"	36"	30"	COEL3036	\$1408	\$1575	\$1703
42"	42"	30"	COEL3042	\$1701	\$1858	\$2006



For Canadian Pricing
 Multiply U.S. Price by the Canadian price factor.
 ▶ See page 1 for details.

Enea Lottus Café Counter Height Tables

DESIGN LIEVORE ALTHERR MOLINA DESIGN ORIGIN: SPAIN

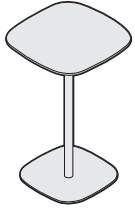

Standard Includes

- Top: laminate or wood veneer with 1/2" thick phenolic core
- Base and frame: steel tubing and base
- Glides: non-skid

Required to Specify

- 1 Style number
- 2 Laminate or wood veneer color number for top
▶ See *Coalesse Surface Materials Reference Guide*.
- 3 Base/frame finish:
4016 White Gloss
4017 Black Gloss
4217 Brown
4218 Platinum Silver
▶ See *Coalesse Surface Materials Reference Guide*.

Specification Information

Dimensions			Style Number	U.S. Prices		
D	W	H		Top Surface:		
				Laminate	Wood 1	Wood 2
24"	24"	36"	COEL3624	\$1012	\$1099	\$1185
30"	30"	36"	COEL3630	\$1252	\$1393	\$1504
36"	36"	36"	COEL3636	\$1443	\$1610	\$1741
42"	42"	36"	COEL3642	\$1732	\$1889	\$2040



For Canadian Pricing
Multiply U.S. Price by the Canadian price factor.
▶ See page 1 for details.

Enea Lottus Café Bar Height Tables

DESIGN LIEVORE ALTHERR MOLINA DESIGN ORIGIN: SPAIN

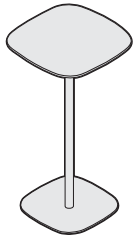

Standard Includes

- Top: laminate or wood veneer with 1/2" thick phenolic core
- Base and frame: steel tubing and base
- Glides: non-skid

Required to Specify

- 1 Style number
- 2 Laminate or wood veneer color number for top
▶ See *Coalesse Surface Materials Reference Guide*.
- 3 Base/frame finish:
4016 White Gloss
4017 Black Gloss
4217 Brown
4218 Platinum Silver
▶ See *Coalesse Surface Materials Reference Guide*.

Specification Information

Dimensions			Style Number	U.S. Prices		
D	W	H		Top Surface:		
				Laminate	Wood 1	Wood 2
24"	24"	42"	COEL4224	\$1040	\$1130	\$1221
30"	30"	42"	COEL4230	\$1283	\$1421	\$1533
36"	36"	42"	COEL4236	\$1470	\$1637	\$1770
42"	42"	42"	COEL4242	\$1822	\$1979	\$2137



For Canadian Pricing
Multiply U.S. Price by the
Canadian price factor.
▶ See page 1 for details.

Enea Lottus Rectangular Tables

DESIGN LIEVORE ALTHERR MOLINA DESIGN ORIGIN: SPAIN

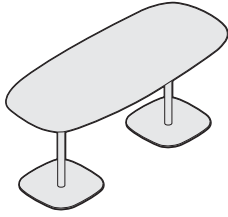

Standard Includes

- Top: laminate or wood veneer with 1/2" thick phenolic core
- Base and frame: steel tubing and base
- Glides: non-skid

Required to Specify

- 1 Style number
- 2 Laminate or wood veneer color number for top
▶ See *Coalesse Surface Materials Reference Guide*.
- 3 Base/frame finish:
4016 White Gloss
4017 Black Gloss
4217 Brown
4218 Platinum Silver
▶ See *Coalesse Surface Materials Reference Guide*.

Specification Information

Dimensions			Style Number	U.S. Prices		
D	W	H		Top Surface:		
				Laminate	Wood 1	Wood 2
30"	72"	30"	COEL303072	\$2747	\$3092	\$3339
30"	72"	36"	COEL363072	\$2808	\$3153	\$3404
30"	72"	42"	COEL423072	\$2867	\$3212	\$3469



For Canadian Pricing
 Multiply U.S. Price by the Canadian price factor.
 ▶ See page 1 for details.

Free Stand

DESIGN STEPHEN COPELAND DESIGN ORIGIN: UNITED STATES



Tip: Worksurface height adjusts from 20"–27" and rotates 360°.

Tip: Free stand is 5" tall when folded/collapsed and weighs 11 pounds.

Tip: Free stand can nest. In nested position each additional unit extends 5 1/4" beyond the previous unit.

Standard Includes	Required to Specify
-------------------	---------------------

- Height-adjustable, soft-touch: 4433 Black
- Foldable/collapsible column: 4144 Black Gloss paint
- Base: 6205 Black plastic

Style number

Specification Information			
Dimensions		Style Number	U.S. Price
D	W		

22 1/4"	21 1/4"	COCFS	\$600
---------	---------	-------	-------



For Canadian Pricing
 Multiply U.S. Price by the
 Canadian price factor.

▶ See page 1 for details.

Coalesse

Free Stand

DESIGN STEPHEN COPELAND DESIGN ORIGIN: UNITED STATES

Ginger

DESIGN GEORGE SIMONS, IDSA DESIGN ORIGIN: UNITED STATES

Tip: Granite is a natural material, and fissures, color, and vein patterns will be inherent.

Tip: Granite tops are crated separately for maximum protection and shipped vertically.

Tip: Bases are not sold separately.

Tip: Contrasting wood top option is available on wood models only.

Tip: Interport not available on 37-1943EL.

Tip: Specify position of module; centered or off-centered, and provide a sketch.

► See *Interport power/data module, page 370.*

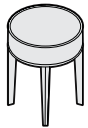

Overall: 18" Dia. 22"H



Overall: 24" Dia. 22"H

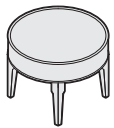

Overall: 24" Dia. 17"H

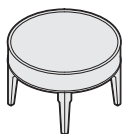

Overall: 31" Dia. 17"H



For Canadian Pricing
Multiply U.S. Price by the Canadian price factor.

► See page 1 for details.

Standard Includes	Required to Specify
<ul style="list-style-type: none"> • Frame: Solid maple and maple veneered frame • Top: <ul style="list-style-type: none"> - Glass: 3/4" thick, green tinted with white enamel bottom - Finesse: 3/4" thick, with Finesse applied - Wood: 3/4" thick, selected maple veneer - Granite: 3/4" thick, available in two finishes: Black Absolute or Ubatuba (Green) • Glides: Polyethylene 	1 Style number 2 Top color number 3 Frame finish 4 Options, if selected (see below) ► See <i>Coalesse Surface Materials Reference Guide.</i>

Options	U.S. Price	Required to Specify
Surface Materials <ul style="list-style-type: none"> • Contrasting wood top 	+\$174	Specify with <i>contrasting wood top.</i>
Interport Power/Data Module <ul style="list-style-type: none"> • Available on wood or Finesse tops only 	+\$306	Specify with <i>Interport</i> and select finish color number.

Specification Information					
Style Number	U.S. Base Prices				
	Top Surface:				
	Finesse	Glass	Wood	Black Absolute Granite	Ubatuba Granite

Round					
37-18RDHF	\$1395	N.A.	N.A.	N.A.	N.A.
37-18RDHGL	N.A.	\$1748	N.A.	N.A.	N.A.
37-18RDHW	N.A.	N.A.	\$1510	N.A.	N.A.
37-18RDHGR	N.A.	N.A.	N.A.	\$1784	\$1795
37-24RDHF	\$1655	N.A.	N.A.	N.A.	N.A.
37-24RDHGL	N.A.	\$2088	N.A.	N.A.	N.A.
37-24RDHW	N.A.	N.A.	\$1735	N.A.	N.A.
37-24RDHGR	N.A.	N.A.	N.A.	\$2464	\$2528
37-24RDLF	\$1620	N.A.	N.A.	N.A.	N.A.
37-24RDLGL	N.A.	\$2045	N.A.	N.A.	N.A.
37-24RDLW	N.A.	N.A.	\$1699	N.A.	N.A.
37-24RDLGR	N.A.	N.A.	N.A.	\$2424	\$2483
37-31RDLF	\$2051	N.A.	N.A.	N.A.	N.A.
37-31RDLGL	N.A.	\$2641	N.A.	N.A.	N.A.
37-31RDLW	N.A.	N.A.	\$2174	N.A.	N.A.
37-31RDLGR	N.A.	N.A.	N.A.	\$4095	\$4266

► Specification Information, continued on next page

Ginger

DESIGN GEORGE SIMONS, IDSA DESIGN ORIGIN: UNITED STATES

► Specification Information, continued from previous page

Specification Information

Style Number	U.S. Base Prices				
	Top Surface:				
	Finesse	Glass	Wood	Black Absolute Granite	Ubatuba Granite



Overall: 19½" Dia. 43"W 17"H

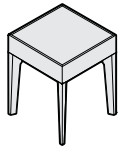

Overall: 18"D 18"W 22"H

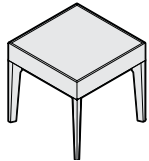

Overall: 24"D 24"W 22"H

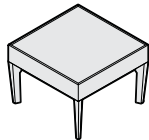

Overall: 24"D 24"W 17"H

Elliptical

37-1943ELF	\$2197	N.A.	N.A.	N.A.	N.A.
37-1943ELGL	N.A.	\$2954	N.A.	N.A.	N.A.
37-1943ELW	N.A.	N.A.	\$2415	N.A.	N.A.
37-1943ELGR	N.A.	N.A.	N.A.	\$4126	\$4268

Square

37-1818HF	\$1395	N.A.	N.A.	N.A.	N.A.
37-1818HGL	N.A.	\$1741	N.A.	N.A.	N.A.
37-1818HW	N.A.	N.A.	\$1510	N.A.	N.A.
37-1818HGR	N.A.	N.A.	N.A.	\$1784	\$1795

37-2424HF	\$1655	N.A.	N.A.	N.A.	N.A.
37-2424HGL	N.A.	\$2088	N.A.	N.A.	N.A.
37-2424HW	N.A.	N.A.	\$1735	N.A.	N.A.
37-2424HGR	N.A.	N.A.	N.A.	\$2464	\$2528

37-2424LF	\$1620	N.A.	N.A.	N.A.	N.A.
37-2424LGL	N.A.	\$2045	N.A.	N.A.	N.A.
37-2424LW	N.A.	N.A.	\$1699	N.A.	N.A.
37-2424LGR	N.A.	N.A.	N.A.	\$2424	\$2483



For Canadian Pricing
 Multiply U.S. Price by the
 Canadian price factor.
 ► See page 1 for details.

Holy Day Tables

DESIGN JEAN-MARIE MASSAUD DESIGN ORIGIN: 2003 SPAIN

*Tip: Glass tops are 1/2" thick.
1/32" chamfers are applied to top
and bottom edges.*

Standard Includes	Required to Specify
-------------------	---------------------

- Top: wood, leather, or glass
- Frame: polished trivalent chrome

- 1 Style number
- 2 Wood color number for top, if selected
▶ See *Coalesse Surface Materials Reference Guide*.
- 3 Leather color number for top, if selected
- 4 Glass color number for top, if selected
- 5 Options, if selected (see below)
▶ See *Coalesse Surface Materials Reference Guide*.

Options	U.S. Price	Required to Specify
---------	------------	---------------------

Contrasting Saddle Stitching	• Available on leather only	No cost Specify with <i>saddle stitching</i> and select thread color.
-------------------------------------	-----------------------------	--

Specification Information

Style Number	U.S. Prices						Leather Grades:	
	Top Surface:						COL	C
	Clear	Clear Green	Absolute	Absolute	Colored	Oak	Walnut	
	Green	Laminated/ Frosted Appearance	Clear Frosted	Clear	Glass			



Overall: 35½"D 10½"H

Round Table with Wood Top

COHD35RDW	N.A.	N.A.	N.A.	N.A.	N.A.	\$2461	\$2489	N.A.	N.A.
-----------	------	------	------	------	------	--------	--------	------	------

Round Table with Leather Top

COHD35RDL	N.A.	N.A.	N.A.	N.A.	N.A.	N.A.	N.A.	\$2094	\$2651
-----------	------	------	------	------	------	------	------	--------	--------

COL/sq ft = 22

Round Table with Glass Top

COHD35RDG	\$3029	\$3408	\$3273	\$3142	\$4112	N.A.	N.A.	N.A.	N.A.
-----------	--------	--------	--------	--------	--------	------	------	------	------

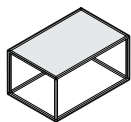

Overall: 27½"D 18"W 14"H

Rectangular Table with Wood Top

COHD30RCW	N.A.	N.A.	N.A.	N.A.	N.A.	\$2061	\$2082	N.A.	N.A.
-----------	------	------	------	------	------	--------	--------	------	------

Rectangular Table with Leather Top

COHD30RCL	N.A.	N.A.	N.A.	N.A.	N.A.	N.A.	N.A.	\$2018	\$2182
-----------	------	------	------	------	------	------	------	--------	--------

COL/sq ft = 11

Rectangular Table with Glass Top

COHD30RCG	\$2597	\$2721	\$2841	\$2976	\$3430	N.A.	N.A.	N.A.	N.A.
-----------	--------	--------	--------	--------	--------	------	------	------	------

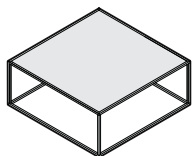

Overall: 35½"D 35½"W 10½"H

Square Table with Wood Top

COHD35SQW	N.A.	N.A.	N.A.	N.A.	N.A.	\$2386	\$2414	N.A.	N.A.
-----------	------	------	------	------	------	--------	--------	------	------

Square Table with Leather Top

COHD35SQL	N.A.	N.A.	N.A.	N.A.	N.A.	N.A.	N.A.	\$2245	\$2612
-----------	------	------	------	------	------	------	------	--------	--------

COL/sq ft = 22

Square Table with Glass Top

COHD35SQG	\$3354	\$3657	\$3960	\$3923	\$4783	N.A.	N.A.	N.A.	N.A.
-----------	--------	--------	--------	--------	--------	------	------	------	------



For Canadian Pricing
Multiply U.S. Price by the
Canadian price factor.
▶ See page 1 for details.

Millbrae

DESIGN COALESSE DESIGN STUDIO DESIGN ORIGIN: USA

Tip: Interport power/data module is not available on Millbrae.

Standard Includes	Required to Specify
<ul style="list-style-type: none"> • Base: cold rolled steel, painted black gloss • Glass top: 3/4" thick glass • Legs: 1/2" x 1 3/4": black gloss • Glides 	1 Style number 2 Glass color number for top 3 Options, if selected (see below) ▶ See <i>Coalesse Surface Materials Reference Guide</i> .

	Options	U.S. Price	Required to Specify
Surface Materials	Base		
	<ul style="list-style-type: none"> • Brushed nickel for side table, 30" x 30" and 36" x 36" square tables, and 20" x 54" and 30" x 60" rectangular tables 	+\$448	Specify with <i>plated metal</i> .
	<ul style="list-style-type: none"> • Brushed nickel for 48" x 48" square table and 30" x 72" rectangular table 	+\$515	Specify with <i>plated metal</i> .

Specification Information								
Dimensions			Style Number	U.S. Base Prices				
D	W	H		Top Surface:				
				Clear	Clear Green	Absolute Clear/ Clear Frosted	Absolute Clear	Colored Glass
				Green	Laminated/ Clear Green Frosted Appearance			

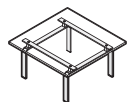

Square Tables

Dimensions	Style Number	U.S. Base Price	U.S. Price	U.S. Price	U.S. Price	U.S. Price
30" x 30" x 15"	COMOTL3030	\$1665	\$1702	\$1774	\$1816	\$1905
36" x 36" x 15"	COMOTL3636	\$1977	\$2024	\$2128	\$2190	\$2321
48" x 48" x 15"	COMOTL4848	\$2705	\$2784	\$2955	\$3084	\$3309

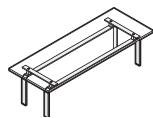

Rectangular Tables

Dimensions	Style Number	U.S. Base Price	U.S. Price	U.S. Price	U.S. Price	U.S. Price
20" x 54" x 15"	COMOTL2054	\$2185	\$2247	\$2316	\$2368	\$2472
30" x 60" x 15"	COMOTL3060	\$2393	\$2455	\$2596	\$2695	\$2866



Side Table

Dimensions	Style Number	U.S. Base Price	U.S. Price	U.S. Price	U.S. Price	U.S. Price
20" x 20" x 20"	COMOTL2020	\$1353	\$1380	\$1410	\$1420	\$1462



For Canadian Pricing
 Multiply U.S. Price by the Canadian price factor.
 ▶ See page 1 for details.

Passerelle

DESIGN STUDIO B DESIGN ORIGIN: UNITED STATES

Tip: Bases are not sold separately.

Tip: Interport not available on 44-T164830.

► See *Interport power/data module*, page 370.

Tip: Specify position of module; centered or off-centered, and provide a sketch.

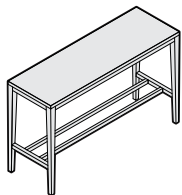
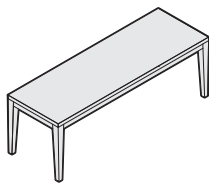
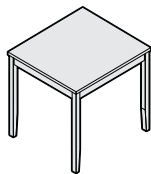
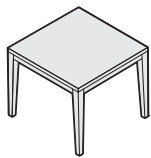

Standard Includes	Required to Specify
<ul style="list-style-type: none"> • Frame: Solid maple with mortise and tenon joinery for structural integrity • Glides: Polyethylene • Wood top: 1" thick, selected maple veneer • Ships ready-to-assemble 	1 Style number 2 Top and frame finish 3 Options, if selected (see below) ► See <i>Coalesse Surface Materials Reference Guide</i> .

Options	U.S. Price	Required to Specify
Surface Materials • Contrasting wood top	+\$174	Specify with <i>contrasting wood top</i> .
Interport Power/Data Module • Interport Power/Data Module	+\$306	Specify with <i>Interport</i> and select finish color number.

Specification Information

Dimensions			Style	U.S. Base Price
D	W	H	Number	Top Surface: Wood
24"	24"	17"	44-T242417	\$ 846
24"	24"	21"	44-T242421	\$ 920
16"	48"	17"	44-T164817	\$1060
16"	48"	30"	44-T164830	\$1266



For Canadian Pricing
 Multiply U.S. Price by the Canadian price factor.
 ► See page 1 for details.

Sebastopol Thought Starters

DESIGN EMILIA BORGTHORSDDOTTIR DESIGN ORIGIN: UNITED STATES

Sebastopol is a unique collection of tables with endless configuration possibilities. It comprises of 2 shapes, each shape being offered in a 16" high and 22" high version. The following are just a few thought starters.

To create these table configurations use the following pieces labeled either A or B in any combination of the two heights, or use them on their own as a stand alone piece.

Shape A:
COEB2723 L or H



Shape B:
COEB4118 L or H

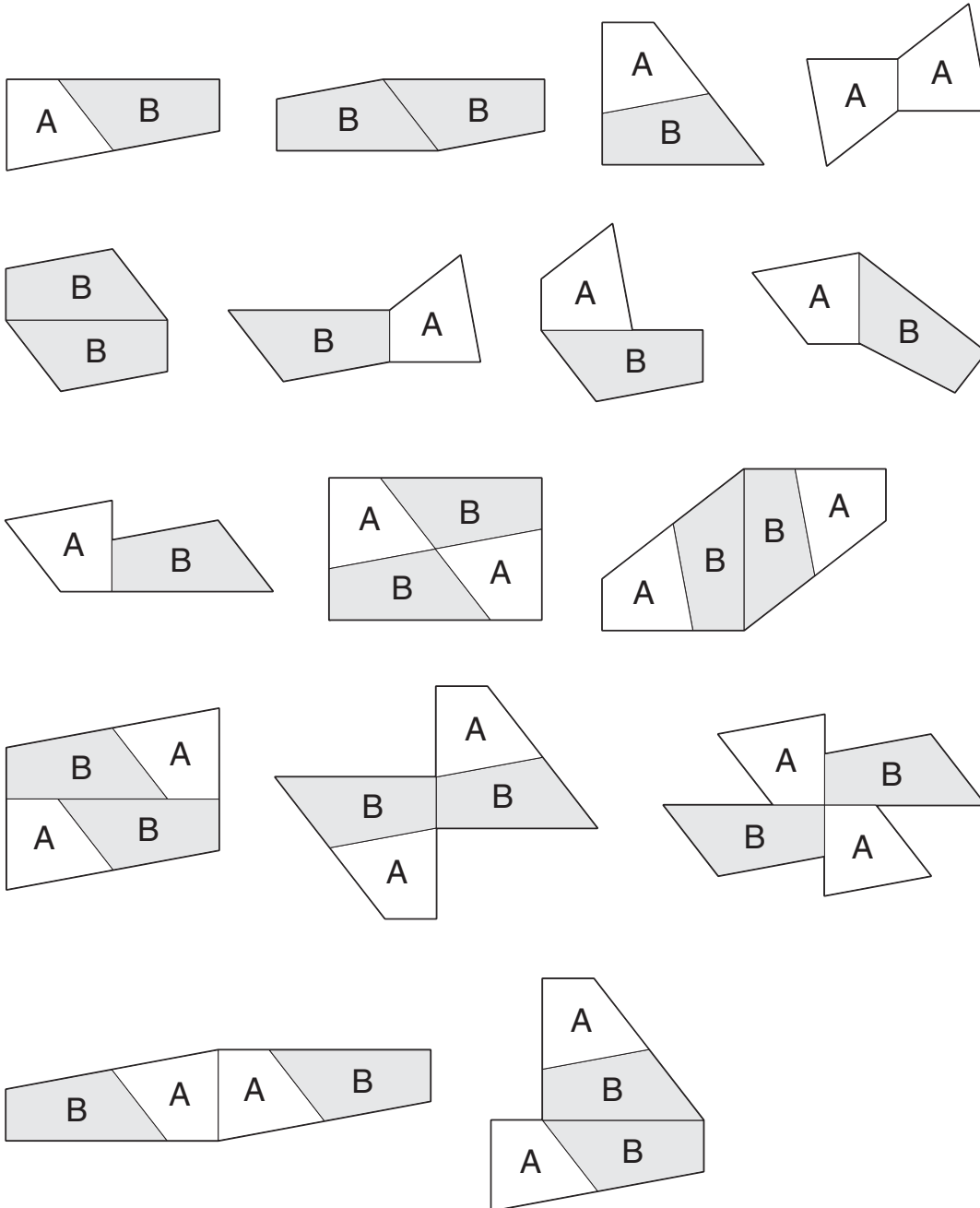
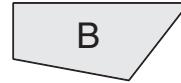

Sebastopol

DESIGN EMILIA BORGTHORSDDOTTIR DESIGN ORIGIN: UNITED STATES

Tables

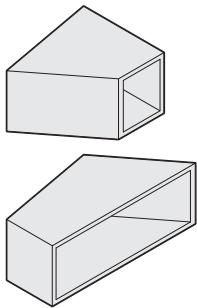

Tip: Optional grommet to accept power pod can be specified in milk white or black plastic.

Standard Includes	Required to Specify
<ul style="list-style-type: none"> Exterior surface: veneer grade 1, oak, or walnut Interior surface: glossy laminate Glides: concealed adjustable glide with non-marking nylon pad 	<ol style="list-style-type: none"> Style number Exterior surface wood finish number Interior surface glossy laminate: <ul style="list-style-type: none"> 2001 Smoky White 2002 Studio Gray 2003 Wrought Iron 2004 Black Pearl 2005 Liberty Red Options, if selected (see below) <p>► See <i>Coalesse Surface Materials Reference Guide</i>.</p>

Options	U.S. Price	Required to Specify
Grommet <ul style="list-style-type: none"> Grommet to accept power pod 	+\$104	Specify <i>with grommet</i> and select finish color number either in milk white or black plastic.

Specification Information					
Dimensions			Style Number	U.S. Base Prices	
D	W	H		Top Surface:	
				Wood Grade 1	Wood Grade 2

16" High Tables

23"	27"	16"	COEB2723L	\$1144	\$1236
18"	41"	16"	COEB4118L	\$1353	\$1461

22" High Tables

23"	27"	22"	COEB2723H	\$1248	\$1348
18"	41"	22"	COEB4118H	\$1457	\$1573



For Canadian Pricing
 Multiply U.S. Price by the Canadian price factor.
 ► See page 1 for details.

Sebastopol

DESIGN EMILIA BORGTHORSDDOTTIR DESIGN ORIGIN: UNITED STATES

Power Pod

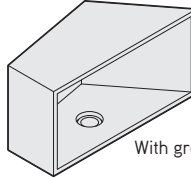
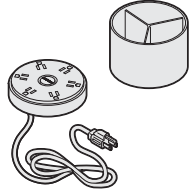

With grommet

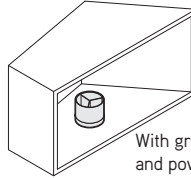

With grommet and power pod

Tip: Leveling glides can be adjusted so that the bottom surface of the table can be anywhere from 5/8" to 1" off of the floor.

Tip: The Power Pod cord will exit out the bottom of the table.

Standard Includes

- Power Pod with 6' and three prong plug: silver bottom cradle and milk face
- Accessory tray: milk
- Six 15-amp power outlets
- Illuminated on/off button
- Surge suppressor

Required to Specify

Style number

Specification Information

Dimensions		Style	U.S.
Dia	H	Number	Price
6"	6"	COPP01	\$162



For Canadian Pricing
 Multiply U.S. Price by the Canadian price factor.
 ▶ See page 1 for details.

Sidewalk Occasional Tables

DESIGN STUDIO B DESIGN ORIGIN: UNITED STATES

Standard Includes	Required to Specify
<ul style="list-style-type: none"> • Frames constructed of finger jointed select hard maple, reinforced with wood substrate • Legs: silver powder coat steel with "Go" glides • Tops: <ul style="list-style-type: none"> - Wood: 1/2" thick veneered tops and quarter cut book-matched hard maple veneer - Glass: 3/16" thick glass sandblasted with white on back surface - Laminate: 1/2" laminate tops available • Ships ready-to assemble 	1 Style number 2 Wood color number for frame ▶ See <i>Coalesse Surface Materials Reference Guide</i> . 3 Laminate color number for top, if selected: ▶ See <i>Coalesse Surface Materials Reference Guide</i> . 4 Options, if selected (see below) ▶ See <i>Coalesse Surface Materials Reference Guide</i> .

Options	U.S. Price	Required to Specify
Glides <ul style="list-style-type: none"> • "No Go" 1/2" polyethylene glides 	No cost	Specify with "No Go" glides.

Specification Information

Dimensions D W H	Style Number	U.S. Prices		
		Top Surface:		
		Wood	Laminate 1	Glass
17" 17" 17"	43-T171717	\$1416	\$1416	\$1659
36" 36" 17"	43-T363617	\$2007	\$2007	\$2244
17" 24" 17"	43-T172417	\$1519	\$1519	\$1763
17" 36" 17"	43-T173617	\$1663	\$1663	\$1900
17" 48" 17"	43-T174817	\$1797	\$1797	\$2034
22" 22" 22"	43-T222222	\$1663	\$1663	\$1900

▶ Specification Information, continued on next page

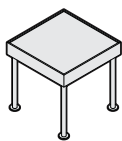
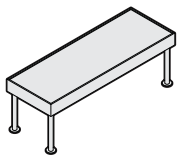
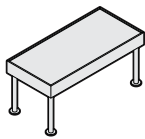
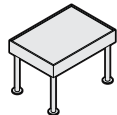
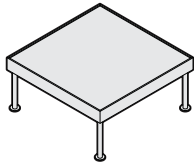
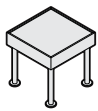

For Canadian Pricing
 Multiply U.S. Price by the
 Canadian price factor.
 ▶ See page 1 for details.

Sidewalk Occasional Tables

DESIGN STUDIO B DESIGN ORIGIN: UNITED STATES

► Specification Information, continued from previous page

Specification Information

Dimensions			Style Number	U.S. Prices		
D	W	H		Top Surface:		
				Wood	Laminate 1	Glass

36"	36"	22"	43-T363622	\$2067	\$2067	\$2316
-----	-----	-----	------------	--------	--------	--------

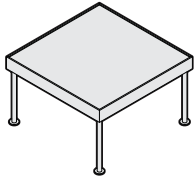

17"	24"	22"	43-T172422	\$1591	\$1591	\$1828
-----	-----	-----	------------	--------	--------	--------

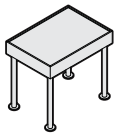

17"	36"	22"	43-T173622	\$1729	\$1729	\$1966
-----	-----	-----	------------	--------	--------	--------

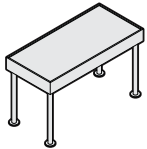

17"	48"	22"	43-T174822	\$1864	\$1864	\$2113
-----	-----	-----	------------	--------	--------	--------

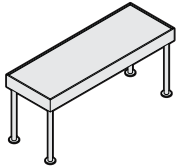

17"	17"	30"	43-T171730	\$1663	\$1663	\$1900
-----	-----	-----	------------	--------	--------	--------

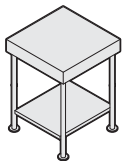

17"	48"	30"	43-T174830	\$2284	\$2284	\$2521
-----	-----	-----	------------	--------	--------	--------

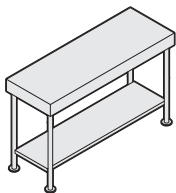

17"	48"	12"	43-T174812	\$1729	\$1729	\$1966
-----	-----	-----	------------	--------	--------	--------

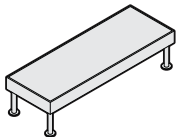

► Specification Information, continued on next page



For Canadian Pricing
 Multiply U.S. Price by the
 Canadian price factor.
 ► See page 1 for details.

Sidewalk Occasional Tables *continued*

DESIGN STUDIO B DESIGN ORIGIN: UNITED STATES

► Specification Information, continued from previous page

Specification Information

Dimensions			Style Number	U.S. Prices		
D	W	H		Top Surface:		
				Wood	Laminate 1	Glass

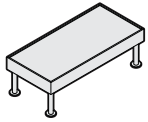

17"	36"	12"	43-T173612	\$1591	\$1591	\$1828
-----	-----	-----	------------	--------	--------	--------

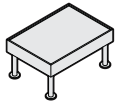

17"	24"	12"	43-T172412	\$1459	\$1459	\$1696
-----	-----	-----	------------	--------	--------	--------

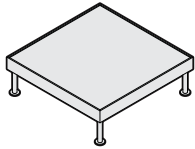

36"	36"	12"	43-T363612	\$2007	\$2007	\$2244
-----	-----	-----	------------	--------	--------	--------



For Canadian Pricing
 Multiply U.S. Price by the
 Canadian price factor.
 ► See page 1 for details.

Sidewalk Storage

DESIGN STUDIO B DESIGN ORIGIN: UNITED STATES

Tip: Credenza Interior dimensions:
 Open Area - 16"D x 28 1/4"W x 13"H
 Closed Area - 14 1/2"D x 15 3/4"W x 13"H

Standard Includes	Required to Specify
<ul style="list-style-type: none"> Storage table/credenza: Hard maple veneer panels Legs: silver powder coat steel with "Go" glide Tops: wood 1/2" thick veneered tops and quarter cut book-matched hard maple veneer Hinges: European on credenza door 	1 Style number 2 Wood color number for storage ▶ See <i>Coalesse Surface Materials Reference Guide</i> . 3 Options, if selected (see below) ▶ See <i>Coalesse Surface Materials Reference Guide</i> .

	Options	U.S. Price	Required to Specify
Glides	<ul style="list-style-type: none"> "No go" 1/2" polyethylene glides 	No cost	Specify with "no go" glides.
Credenza	<ul style="list-style-type: none"> Hinges on facing door 	No cost	Specify with left on facing door or right on facing door.

Specification Information			
Dimensions		Style	U.S. Price
D	W	H	Number
			Top Surface: Wood

Storage Table

17" 20" 17" 43-ST172017 \$1381

17" 17" 17" 43-ST171717 \$1315

Credenza

17" 48" 20" 43-S174820 \$2484

17" 48" 33" 43-S174833 \$2561

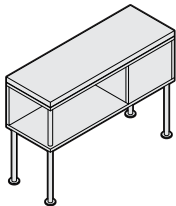
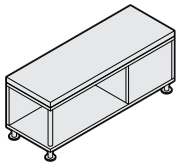
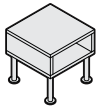
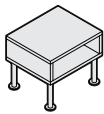

For Canadian Pricing
 Multiply U.S. Price by the Canadian price factor.
 ▶ See page 1 for details.

Soft Leaf

DESIGN NORMAN DIEKMAN DESIGN ORIGIN: UNITED STATES

Tip: Glass puddle dimensions are 17" x 19", 1/2" thick.

Tip: Attached aluminum disc or puddle not available on 49-SFTH17B. Unattached only.

Tip: Fabrics and leathers will appear loose with comfort wrinkles when upholstered.

Tip: Due to the design and construction techniques of Soft Leaf tables, only certain textiles can be successfully applied, therefore COM fabrics must be submitted to Coalesse for approval prior to order acceptance.

Standard Includes		Required to Specify	
<ul style="list-style-type: none"> • Frame: Unibody construction with finger jointed plywood • Upholstery: Multiple densities of laminated polyurethane • Glides: Height adjustable polyurethane leveling 		1 Style number 2 Fabric color number 3 Options, if selected (see below) ► See <i>Coalesse Surface Materials Reference Guide</i> .	
Options		U.S. Price	Required to Specify
Surface Materials	Fire code seating		
	<ul style="list-style-type: none"> • CAL 133 	+\$ 218	Specify with CAL 133. ► See <i>Coalesse Surface Materials Reference Guide</i> .
Puddle	Acrylic backer		
	<ul style="list-style-type: none"> • Backer for 49-SFTH21C, 49-SFTH23D, and 49-SFTH23E • Backer for 49-SFTH15A and 49-SFTH17B 	+\$ 17 +\$ 27	Specify with acrylic backer. ► See <i>Coalesse Surface Materials Reference Guide</i> .
Disc	• Brushed aluminum	+\$ 508	Specify with brushed aluminum puddle and indicate attached or unattached.
	• Glass puddle	+\$ 368	Specify with glass puddle and indicate attached or unattached.
	• 36" round glass top with unattached brush aluminum disc	+\$1446	Specify with brush aluminum disc.
	• 36" round glass top with unattached brush aluminum puddle	+\$1493	Specify with brush aluminum puddle.
Glass	• 36" round glass top with unattached glass puddle	+\$1601	Specify with glass puddle.
	• Brushed aluminum 13 3/4" disc	+\$ 321	Specify with brushed aluminum disc attached or unattached.
Glass	• 36" round glass top, unattached (Model 49-SFTH15A only)	+\$1126	Specify with 36" round glass top.

Specification Information

Style Number	U.S. Base Prices											Leather Grades:		
	COM	6	7	8	9	10	11	12	13	14	COL	C	E	
49-SFTH21C	\$497	\$523	\$543	\$561	\$596	\$619	\$703	\$756	\$791	\$918	\$769	\$1742	\$1919	
COM/yds = 2, COL/sq ft = 44														
49-SFTH23D	\$497	\$523	\$543	\$561	\$596	\$619	\$703	\$756	\$791	\$918	\$769	\$1742	\$1919	
COM/yds = 2, COL/sq ft = 44														
49-SFTH23E	\$515	\$536	\$556	\$579	\$609	\$631	\$714	\$768	\$809	\$939	\$781	\$1760	\$1932	
COM/yds = 2, COL/sq ft = 44														

► Specification Information, continued on next page

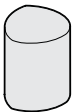

Overall: 16"D 17 1/2"W 21"H

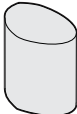

Overall: 18 1/2"D 16"W 23"H

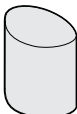

Overall: 17 1/4"D 16"W 23"H



For Canadian Pricing
 Multiply U.S. Price by the Canadian price factor.
 ► See page 1 for details.

Soft Leaf

DESIGN NORMAN DIEKMAN DESIGN ORIGIN: UNITED STATES

► Specification Information, continued from previous page

Specification Information

Style Number	U.S. Base Prices											Leather Grades:		
	Fabric Grades:											COL	C	E
	COM	6	7	8	9	10	11	12	13	14				

Upholstered

49-SFTH15A	\$599	\$668	\$698	\$721	\$768	\$810	\$933	\$1017	\$1063	\$1230	\$871	\$2364	\$2630
-------------------	-------	-------	-------	-------	-------	-------	-------	--------	--------	--------	-------	--------	--------

COM/yds = 3, COL/sq ft = 66

49-SFTH17B	\$648	\$712	\$742	\$764	\$811	\$847	\$971	\$1060	\$1107	\$1282	\$920	\$2400	\$2666
-------------------	-------	-------	-------	-------	-------	-------	-------	--------	--------	--------	-------	--------	--------

COM/yds = 3, COL/sq ft = 66

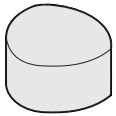

Overall: 29½"D 28"W 15½"H

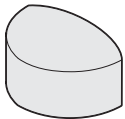

Overall: 39½"D 28½"W 17"H



For Canadian Pricing
 Multiply U.S. Price by the
 Canadian price factor.
 ► See page 1 for details.



Standard Includes	Required to Specify
<ul style="list-style-type: none"> • 1/2" thick top surface: <ul style="list-style-type: none"> - Laminate (Grade 1) with 3 mm edge band, if selected - Wood veneer (Grade 1) with matching 3 mm edge band, if selected - Corian, if selected: white only - Glass, if selected • 1/4" thick bottom substructure: black or milk • Base, column, and cone: 8040 Polished Matte Aluminum • Glides • Ships ready-to assemble 	<ol style="list-style-type: none"> 1 Style number with appropriate top series letter indicated in the space provided. (For example: COWO_RND30 becomes COWOLRND30 for a laminate top surface): <ul style="list-style-type: none"> L - Laminate top V - Wood veneer top C - Corian top G - Glass top 2 Laminate, wood, or glass color number for top, if selected 3 Plastic color for edge band of laminate top, if selected 4 Bottom substructure: <ul style="list-style-type: none"> 6000 Black 6052 Milk 5 Options, if selected (see below) <ul style="list-style-type: none"> ▶ See <i>Coalesse Surface Materials Reference Guide</i>.

	Options	U.S. Price	Required to Specify
Surface Materials	Laminate		
	• Grade 2 laminate	Prices at right	Specify with <i>Grade 2 laminate</i> and select color number.
	Wood		
	• Grade 2 wood veneer	Prices at right	Specify with <i>Grade 2 wood veneer</i> and select color number.
	• Grade 1 wedge layup veneer	Prices at right	Specify with <i>Grade 1 wedge veneer layup</i> and select color number.
	• Grade 2 wedge layup veneer	Prices at right	Specify with <i>Grade 2 wedge veneer layup</i> and select color number.
	• Stain-to-Match	No cost	Specify with <i>Stain-to-Match</i> . ▶ See <i>Coalesse Surface Materials Reference Guide</i> .
Grommet	42" and 48" round, 42" square and 45 1/2" super-square tables		
	• One grommet (center only)	+\$108	Specify with <i>one grommet</i> .
	• One grommet	+\$108	Specify with <i>one grommet</i> .
	60" large round and large square tables		
	• Two grommets	+\$216	Specify with <i>two grommets</i> .
Related Products	• Power Pod		▶ Page 353
	• SW_1 lounge		▶ Page 193

Tip: If grommet is selected, the finish is not selectable, it will be the same as the substructure finish choice.

Tip: There is no vertical wire manager with grommet selection.

Veneer direction



For Canadian Pricing
Multiply U.S. Price by the Canadian price factor.
▶ See page 1 for details.

SW_1 Occasional Tables

DESIGN SCOTT WILSON & MINIMAL

Tip: Your specification is not complete until you add the fifth letter to the style number to define top surface.

- L - Laminate top
- V - Wood veneer top
- C - Corian top
- G - Glass top

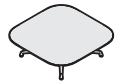
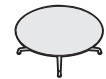

Specification Information

Dimensions			Style Number	U.S. Base Prices				Wedge Veneer Layout		Corian	Glass
L	W	H		Laminate	Veneer	Layup					
				Grade 1	Grade 2	Grade 1	Grade 2	Grade 1	Grade 2		
Round											
30" diameter	15"		COWO_RND30	\$1596	\$1624	\$2235	\$2343	N.A.	N.A.	\$2376	\$2862
36" diameter	15"		COWO_RND36	\$1650	\$1688	\$2309	\$2471	\$3607	\$3770	\$2484	\$3132
42" diameter	15"		COWO_RND42	\$1704	\$1758	\$2386	\$2602	\$4063	\$4279	\$2592	\$3403
48" diameter	15"		COWO_RND48	\$1813	\$1883	\$2538	\$2782	\$4377	\$4621	\$2700	\$3674
Large Round											
60" diameter	15"		COWO_RND60	\$2759	\$2858	\$3889	\$4244	\$6649	\$6981	\$5856	\$6992
Square											
30"	30"	15"	COWO_SQ30	\$1650	\$1678	\$2309	\$2417	N.A.	N.A.	\$2484	\$3132
36"	36"	15"	COWO_SQ36	\$1704	\$1742	\$2386	\$2548	N.A.	N.A.	\$2592	\$3403
42"	42"	15"	COWO_SQ42	\$1813	\$1867	\$2538	\$2754	N.A.	N.A.	\$2700	\$3674
Large Square											
60"	60"	15"	COWO_SQ60	\$2841	\$2942	\$3998	\$4363	N.A.	N.A.	\$6020	\$7320
Super-Square											
45½"	45½"	15"	COWO_SSQ45	\$1893	\$1963	\$2646	\$2890	\$4485	\$4713	\$2862	\$3944

 **For Canadian Pricing**
 Multiply U.S. Price by the Canadian price factor.
 ▶ See page 1 for details.

Swathmore Plus Beveled

DESIGN MICHAEL SHIELDS, IDSA DESIGN ORIGIN: UNITED STATES

 = Available in Rapid10.

Tip: Bases are not sold separately.

Tip: Granite is a natural material, and fissures, color, and vein patterns will be inherent.

Tip: Granite tops are crated separately for maximum protection and shipped vertically.

Tip: Contrasting wood top option is available on wood models only.

Tip: Specify position of module, centered or off-centered, and provide a sketch.
 ▶ See Interport power/data module, page 370.

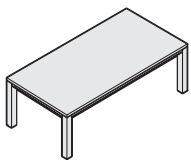
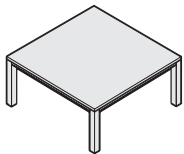
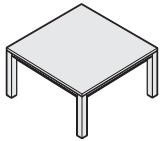
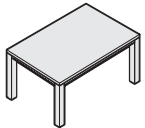
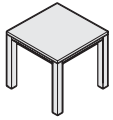

Standard Includes	Required to Specify
<ul style="list-style-type: none"> • Frame: Solid maple with dowels and corner braces for structural integrity • Tops: <ul style="list-style-type: none"> - Glass: 3/4" thick, sand blasted glass - Finesse: 3/4" thick, with chamfered edge and Finesse applied - Wood: 3/4" thick, selected maple veneer top and solid maple chamfered edge - Granite: 3/4" thick, available in two finishes: Black Absolute or Ubatuba (Green) • Glides: Polyethylene 	1 Style number 2 Top color number 3 Frame finish 4 Options, if selected (see below) ▶ See <i>Coalesse Surface Materials Reference Guide</i> .

Options	U.S. Price	Required to Specify
Surface Materials <ul style="list-style-type: none"> • Contrasting wood top 	+ \$174	Specify with <i>contrasting wood top</i> .
Interport Power/Data Module <ul style="list-style-type: none"> • Available on wood or Finesse tops 	+ \$306	Specify with <i>Interport</i> and select finish color number.

Specification Information

Dimensions D W H	Style Number	U.S. Base Prices				Glass	Black Absolute Granite	Ubatuba Granite
		Top Surface:						
		Finesse	Wood					
20" 20" 16 1/2"	50-2020LF	\$1063	N.A.	N.A.	N.A.	N.A.	N.A.	N.A.
20" 20" 16 1/2"	50-2020LW	N.A.	\$1276	N.A.	N.A.	N.A.	N.A.	N.A.
20" 20" 16 1/2"	50-2020LGL	N.A.	N.A.	\$1076	N.A.	N.A.	N.A.	N.A.
20" 20" 16 1/2"	50-2020LGR	N.A.	N.A.	N.A.	\$1737			\$2086
20" 30" 16 1/2"	50-2030LF	\$1117	N.A.	N.A.	N.A.	N.A.	N.A.	N.A.
20" 30" 16 1/2"	50-2030LW	N.A.	\$1417	N.A.	N.A.	N.A.	N.A.	N.A.
20" 30" 16 1/2"	50-2030LGL	N.A.	N.A.	\$1241	N.A.	N.A.	N.A.	N.A.
20" 30" 16 1/2"	50-2030LGR	N.A.	N.A.	N.A.	\$2110			\$2524
30" 30" 16 1/2"	50-3030LF	\$1229	N.A.	N.A.	N.A.	N.A.	N.A.	N.A.
30" 30" 16 1/2"	50-3030LW	N.A.	\$1543	N.A.	N.A.	N.A.	N.A.	N.A.
30" 30" 16 1/2"	50-3030LGL	N.A.	N.A.	\$1354	N.A.	N.A.	N.A.	N.A.
30" 30" 16 1/2"	50-3030LGR	N.A.	N.A.	N.A.	\$2569			\$3184
36" 36" 16 1/2"	50-3636LF	\$1495	N.A.	N.A.	N.A.	N.A.	N.A.	N.A.
36" 36" 16 1/2"	50-3636LW	N.A.	\$1956	N.A.	N.A.	N.A.	N.A.	N.A.
36" 36" 16 1/2"	50-3636LGL	N.A.	N.A.	\$1720	N.A.	N.A.	N.A.	N.A.
36" 36" 16 1/2"	50-3636LGR	N.A.	N.A.	N.A.	\$3410			\$4291
24" 48" 16 1/2"	50-2448LF	\$1347	N.A.	N.A.	N.A.	N.A.	N.A.	N.A.
24" 48" 16 1/2"	50-2448LW	N.A.	\$1896	N.A.	N.A.	N.A.	N.A.	N.A.
24" 48" 16 1/2"	50-2448LGL	N.A.	N.A.	\$1654	N.A.	N.A.	N.A.	N.A.
24" 48" 16 1/2"	50-2448LGR	N.A.	N.A.	N.A.	\$3244			\$4113

▶ Specification Information, continued on next page

Swathmore Plus Beveled

DESIGN MICHAEL SHIELDS, IDSA DESIGN ORIGIN: UNITED STATES

 = Available in Rapid10.

► Specification Information, continued from previous page

Specification Information

Dimensions			Style Number	U.S. Base Prices				
D	W	H		Top Surface:				
				Finesse	Wood	Glass	Black Absolute Granite	Ubatuba Granite
20"	20"	21"	50-2020HF	\$1071	N.A.	N.A.	N.A.	N.A.
	20"	21"	50-2020HW	N.A.	\$1283	N.A.	N.A.	N.A.
20"	20"	21"	50-2020HGL	N.A.	N.A.	\$1093	N.A.	N.A.
20"	20"	21"	50-2020HGR	N.A.	N.A.	N.A.	\$1743	\$2015
30"	30"	21"	50-3030HF	\$1260	N.A.	N.A.	N.A.	N.A.
30"	30"	21"	50-3030HW	N.A.	\$1567	N.A.	N.A.	N.A.
30"	30"	21"	50-3030HGL	N.A.	N.A.	\$1388	N.A.	N.A.
30"	30"	21"	50-3030HGR	N.A.	N.A.	N.A.	\$2606	\$3209
36"	36"	21"	50-3636HF	\$1553	N.A.	N.A.	N.A.	N.A.
36"	36"	21"	50-3636HW	N.A.	\$2003	N.A.	N.A.	N.A.
36"	36"	21"	50-3636HGL	N.A.	N.A.	\$1779	N.A.	N.A.
36"	36"	21"	50-3636HGR	N.A.	N.A.	N.A.	\$3468	\$4342

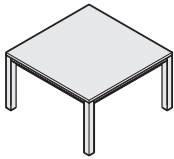
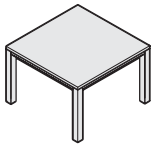
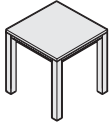

For Canadian Pricing
 Multiply U.S. Price by the
 Canadian price factor.
 ► See page 1 for details.

Switch

DESIGN EOOS DESIGN ORIGIN: GERMANY

Tip: Interport power/data module is not available on Switch.

Standard Includes	Required to Specify
-------------------	---------------------

- Base: satin silver plated tubing
- Trivalent satin chrome finish
- Glass top: 5/8" thick, green tinted glass tops have radiused corners
- Adjustable glides

Style number
 ▶ See *Coalesse Surface Materials Reference Guide*.

Specification Information

Dimensions			Style	U.S. Price
D	W	H	Number	Top Surface: Glass

Square

24 ³ / ₈ "	24 ³ / ₈ "	15"	39-2424	\$1737
----------------------------------	----------------------------------	-----	---------	--------

Rectangle

24 ³ / ₈ "	43 ¹ / ₄ "	15"	39-2442	\$2139
----------------------------------	----------------------------------	-----	---------	--------

Square

36"	36"	15"	39-3636	\$2304
-----	-----	-----	---------	--------

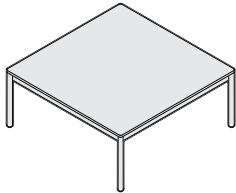
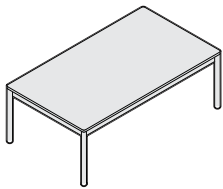
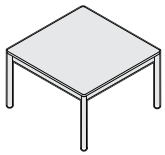

For Canadian Pricing
 Multiply U.S. Price by the
 Canadian price factor.
 ▶ See page 1 for details.

TeamWork Satellite Table

Satellite table provides a personal worksurface adjacent to seating and primary or nesting-height worksurfaces.

Top has a laminate or wood veneer surface with a matching edge.

Legs are finished with paint.

Glides are black.

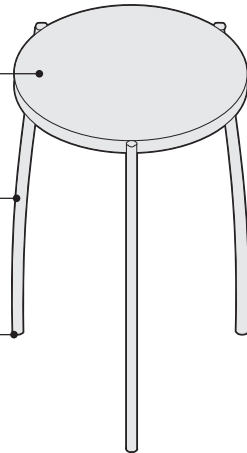

Product Details

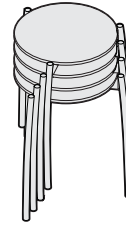

Tables stack up to four high.

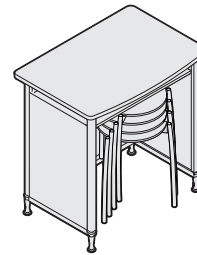

Height of table allows it to stow beneath other worksurfaces or Detour station garage.

Connections

Satellite table is fully assembled.

Surface Materials

Top and edge

- Laminate (Grade 1 or Grade 2)
- Wood veneer
- Custom wood finish (option on wood)

Legs

- Paint

Glides

- Black plastic only

Designer

Metro Design Group | San Francisco and Brian Kenneth Graham with the Gensler Product Design Group

Actual Dimensions

Top diameter	17"
Width of base	19"
Height	25"
Thickness	1/2"

TeamWork Satellite Table

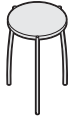

Standard Includes		Required to Specify
<ul style="list-style-type: none"> ▶ Need help? Product details, page 365 	<ul style="list-style-type: none"> • Top: laminate (Grade 1) or wood veneer • Legs: paint • Glides: black plastic only 	<ol style="list-style-type: none"> 1 Style number 2 Laminate or wood color number for top 3 Paint color number for legs 4 Options, if selected (see below) <p>▶ See <i>Coalesse Surface Materials Reference Guide</i>.</p>

Options	U.S. Price	Required to Specify
Surface Materials <ul style="list-style-type: none"> • Custom wood finish 	Wood	<p>▶ See <i>Coalesse Surface Materials Reference Guide</i>.</p>

Specification Information						
Dimensions		Style Number	U.S. Prices			
Dia.	H		Lam 1	Lam 2	Wood 1	Wood 2
17"	25"	TW19004	\$558	\$586	\$691	\$860



For Canadian Pricing
 Multiply U.S. Price by the Canadian price factor.
 ▶ See page 1 for details.

Coalesse

TeamWork

Satellite Table

Trees

DESIGN NORMAN DIEKMAN DESIGN ORIGIN: UNITED STATES

Tip: Interport power/data module is not available on Trees.

Tip: Tops come in the same wood and finish but with smooth surface.

Standard Includes	Required to Specify
<ul style="list-style-type: none"> Stainless steel is constructed of parts that are laser-cut and all seams are welded using jigs and fixtures to ensure precision <ul style="list-style-type: none"> - Base: powder coated carbon steel - Adjustable glides for leveling - Units are sanded and polished smooth to a standard metal finish - No top coat is used or needed - Glides: height adjustable Embossed Wood is created under high pressure to add dimensionality and texture on all sides of the table <ul style="list-style-type: none"> - Interior frame is constructed from a combination of engineered lumber and hardwood veneers - Embossed hardwood veneer is applied to all vertical and slanted surfaces Hand Polished, High Gloss Paint: Hard maple veneer is applied to form the face of the frame and top <ul style="list-style-type: none"> - All exposed wood surfaces are inspected and thoroughly hand sanded prior to the application of finish material - Coating is a tough, pigmented, two-component polyurethane. Once cured, coating is hand-polished to a high gloss. Specify blue or yellow. SensiTile is a terrazzo material with a matrix of fiber optic "lightpipes" <ul style="list-style-type: none"> - Changes in light and shadow are transmitted through the optics to create a responsive, shimmering light effect - Surface will require periodic care, and blemishes are natural occurrences in terrazzo - Unit is coated in wax: Black 	<ol style="list-style-type: none"> Style number Top color number Frame finish Options, if selected (see below) <p>► See <i>Coalesse Surface Materials Reference Guide</i>.</p>

Options	U.S. Price	Required to Specify
Surface Materials <ul style="list-style-type: none"> Bevel High embossed wood (Model 70-C-TPM) available in Medium Brown Bevel Medium embossed wood (Model 70-D-TPM) available in Medium Brown 	+\$64 +\$64	Specify with <i>Medium Brown</i> . Specify with <i>Medium Brown</i> .

Specification Information

Dimensions	Style	U.S.
D W H	Number	Base Price

Curve Low, Lacquer Paint–High Gloss

16½"	14"	15¾"	70-E-PTM	\$1997
------	-----	------	----------	--------

Curve Low, Lacquer Paint (2 Bases)–Glass Top

32"	40"	16¾"	70-EEG1	\$5088
-----	-----	------	---------	--------

Curve Low/Cube, Low Wood, Lacquer–Glass Top

32"	40"	16¾"	70-EFG1	\$4848
-----	-----	------	---------	--------

► Specification Information, continued on next page

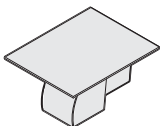
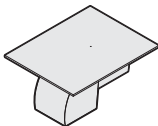
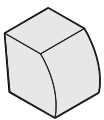

Trees

DESIGN NORMAN DIEKMAN DESIGN ORIGIN: UNITED STATES

► Specification Information, continued from previous page

Specification Information

Dimensions			Style	U.S.
D	W	H	Number	Base Price

Curve High–Stainless Steel

15½"	14"	23"	70-A-SMM	\$2868
------	-----	-----	----------	--------

Cube Low

SensiTile

19½"	19"	15¾"	70-F-LPT	\$4434
------	-----	------	----------	--------

Embossed Wood/Black Only

19½"	19"	15¾"	70-F-TPM	\$1790
------	-----	------	----------	--------

Fold High–Stainless Steel

15¾"	14"	23"	70-B-SMM	\$3100
------	-----	-----	----------	--------

Bevel High–Embossed Wood

15½"	14"	23"	70-C-TPM	\$2192
------	-----	-----	----------	--------

Bevel Medium–Embossed Wood

15½"	14"	19¾"	70-D-TPM	\$2135
------	-----	------	----------	--------

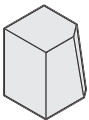
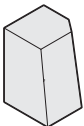
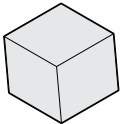
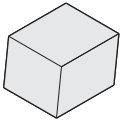
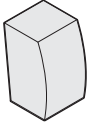

For Canadian Pricing
 Multiply U.S. Price by the
 Canadian price factor.
 ► See page 1 for details.

Interport Power Module for Occasional Tables

New York City Approved.
Calendar #43897

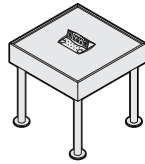

Centered Position
Shown on Sidewalk
43-T171717 Table

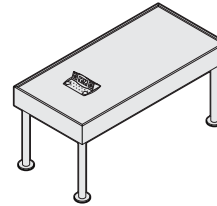

Off-Center Position
(sketch required)
Shown On Sidewalk
43-T173617 Table

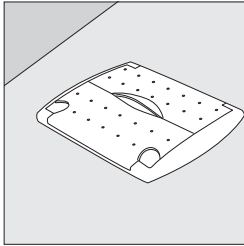

Closed: Power and data ports and cords are neatly hidden away but ready to be accessed with an easy flip of the top.

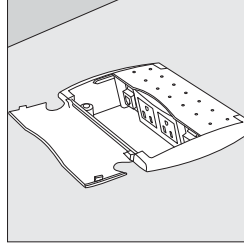

Half Open: Exposes power and data ports. Power available. Data available. Overall dimensions are: 7W x 5D x 2H opened.

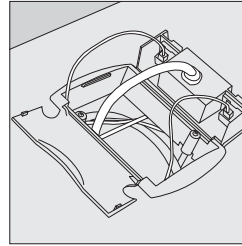

Completely Open / Inside: Reveals coiled power and data cords contained within caddy.

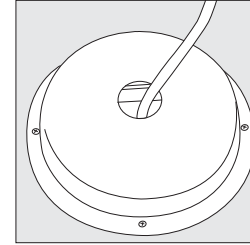

Bottom: Power and data cords exit through hole in the bottom of the caddy.

Available Models: Options: Available on wood, laminate and finesse covered tops only. Not available on glass or granite tops. Center and off center positions - not available on every model. Check grid for position availability. Interport is not available on all Coalesse and CoalesseSpaces models. Check grid for model availability.

Table	Model	Centered	Off Center
Avon	19-2020	Yes	No
	19-2448	Yes	Yes
	19-2030	No	Yes
	21-2020	Yes	No
	19-3030	Yes	Yes
	21-3030	Yes	Yes
	19-3636	Yes	Yes
	21-3636	Yes	Yes
	21-3636	Yes	Yes
Donovan	36-18RD H	Yes	No
	36-1943 EL	No	No
	36-24RD H	Yes	No
	36-1818 H	Yes	No
	36-24RD L	Yes	No
	36-2424 H	Yes	Yes
	36-31RD L	Yes	No
	36-2424 L	Yes	Yes
Ginger	37-18RD H	Yes	No
	37-1943 EL	No	No
	37-24RD H	Yes	No
	37-1818 H	Yes	No
	37-24RD L	Yes	No
	37-2424 H	Yes	Yes
	37-31RD L	Yes	No
	37-2424 L	Yes	Yes

Table	Model	Centered	Off Center
Passerelle	440-T242417	Yes	No
	440-T164817	No	Yes
	440-T242421	Yes	No
	440-T164830	No	No
Sidewalk	43-T174830	No	Yes
	43-T222222	Yes	No
	43-T171730	Yes	No
	43-T174817	No	Yes
	43-T174822	No	Yes
	43-T173617	No	Yes
	43-T173622	No	Yes
	43-T172417	Yes	No
	43-T172422	Yes	No
	43-T363617	Yes	Yes
	43-T363622	Yes	Yes
	43-T171717	Yes	No
	43-T174812	No	Yes
	43-T484812	Yes	Yes
	43-T173612	No	Yes
43-T363612	Yes	Yes	
43-T172412	Yes	No	

Table	Model	Centered	Off Center
Swathmore Plus	50-2020L	Yes	No
	50-2448L	Yes	Yes
	50-2030L	No	Yes
	50-2020H	Yes	No
	50-3030L	Yes	Yes
	503030H	Yes	Yes
	50-3636L	Yes	Yes
	50-3636H	Yes	Yes
	50-3636H	Yes	Yes

Specify color: Silver Mica
Matte Black Nickel Mica
Charcoal Mica Translucent

® Trademark of Byrne Electrical, Rockford, Michigan

Indoor/Outdoor Seating

Emu Advanced Collection

Product Weights	372
Emu Heaven	374
Emu Ivy	380
Emu Pattern	383
Emu Re-Trouvé	386
Emu Round	388
Emu Shade	391
Emu Dolly	392

Emu Advanced Collection Product Weights

Product Weights		Style Number	Product Weights Per Item (Pounds)
Emu Heaven Seating		Emu Round Tables	
CO2485	16	CO2472	44
CO2486	18 ³ / ₄	CO2471	48 ¹ / ₂
CO2487	25	CO2473	60
CO2495	8	CO2470	50 ³ / ₄
CO2495V	6 ¹ / ₂	CO2474	92 ¹ / ₄
CO2498	45	CO2475	51 ³ / ₄
CO2497	51 ¹ / ₄	CO2477	25 ³ / ₄
		CO2478	26 ¹ / ₂
Emu Heaven Tables		Emu Shade	
CO2493	16	CO2981	120 ¹ / ₄
CO2494	29	CO2980	79
CO2499	29	CO2982	103 ³ / ₄
CO2496	17	CO2984	98 ¹ / ₄
CO2493V	16 ¹ / ₂		
CO2494V	49 ¹ / ₂		
CO2499V	58 ¹ / ₄		
Emu Ivy Seating			
CO2581	14 ¹ / ₄		
CO2582	16 ¹ / ₄		
CO2585	35 ³ / ₄		
CO2586	55 ¹ / ₂		
CO2595	18 ¹ / ₄		
Emu Ivy Tables			
CO2589	31 ¹ / ₄		
CO2591	83 ³ / ₄		
CO2592	172		
CO2593	159 ¹ / ₄		
CO2596	46 ¹ / ₄		
CO2597	63 ³ / ₄		
Emu Pattern Seating			
CO2510	16		
CO2511	17 ¹ / ₂		
CO2512	27 ³ / ₄		
Emu Pattern Tables			
CO2518	31 ¹ / ₄		
CO2519	41 ³ / ₄		
CO2520	52 ¹ / ₂		
Emu Re-Trouvé Seating			
CO2565MB	16		
CO2566HB	19 ¹ / ₂		
CO2575	11		
CO2578	16 ¹ / ₄		
CO2577	20 ³ / ₄		
CO2580	33		
Emu Round Seating			
CO2467	14 ¹ / ₂		
CO2465	12 ¹ / ₂		
CO2466	15 ¹ / ₄		
CO2469	20 ³ / ₄		

Coalesse

Emu Advanced Collection

Product Weights

Emu Advanced Collection Emu Heaven – Seating

DESIGN JEAN-MARIE MASSAUD

Tip: All chairs can stack four high.

Tip: COM outdoor fabric must be an approved outdoor fabric.

Tip: Fire code seating (FCS) is only available with certain upholstery fabric choices.

Standard Includes	Required to Specify
-------------------	---------------------

- Frame: hand crafted woven steel mesh
- Finish: outdoor grade powder coat paint
- Glides: nylon
- Cushions: fabric

- 1 Style number
 - 2 Powder coat color for frame
 - 3 Fabric color number for upholstery on cushions, if selected
 - 4 Options, if selected (see below)
- ▶ See *Coalesse Surface Materials Reference Guide*.

Options	U.S. Price	Required to Specify
---------	------------	---------------------

Surface Materials	Fire code seating • CAL 133 (applies to indoor cushions and pillows only)	+\$113	Specify with <i>CAL 133</i> . ▶ See <i>Coalesse Surface Materials Reference Guide</i> .
	Acrylic backer • Backer for indoor chair cushions • Backer for indoor chair back cushions • Backer for indoor lounge back cushions • Backer for indoor pouf and pillow cushions	+\$ 12 +\$ 10 +\$ 21 +\$ 6	Specify with <i>acrylic backer</i> . Specify with <i>acrylic backer</i> . Specify with <i>acrylic backer</i> . Specify with <i>acrylic backer</i> . ▶ See <i>Coalesse Surface Materials Reference Guide</i> .

Specification Information					
Dimensions			Style Number	Quantity	U.S. Base Price
D	W	H			

Chair

23¾"	24½"	31"	CO2485	2	\$1158
------	------	-----	--------	---	--------



Seat height: 17¾"
Seat depth: 16⅙"

Arm Chair

24"	27¼"	31"	CO2486	2	\$1328
-----	------	-----	--------	---	--------



Seat height: 17¾"
Seat depth: 16⅙"
Arm height: 26¾"

Lounge Chair

30¾"	37"	27¼"	CO2487	2	\$2226
------	-----	------	--------	---	--------

▶ Specification Information, continued on next page

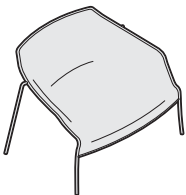

Seat height: 13¾"
Seat depth: 18½"
Arm height: 20½"

Emu Advanced Collection Emu Heaven – Seating

DESIGN JEAN-MARIE MASSAUD

Tip: All cushions come in quantity of one.

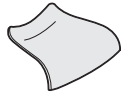

20¾" D x 14½" W x 19" W x ¾" H

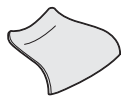

20¾" D x 23¾" W x ¾" H



Overall: ¾" D x 22" W x 15½" H

Tip: If a back cushion is specified, a seat cushion must also be specified. The back cushion is not functional without the seat cushion.

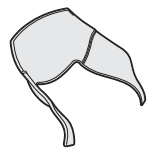

Overall: ¾" D x 28" W x 17½" H



Overall: ¾" D x 34" W x 25" H

Tip: If a back cushion is specified, a seat cushion must also be specified. The back cushion is not functional without the seat cushion.

► Specification Information, continued from previous page

Specification Information

Style Number	U.S. Base Prices											Leather Grades:		
	Fabric Grades:											COL	C	E
	COM	6	7	8	9	10	11	12	13	14				

Chair Cushions

Outdoor Cushion

CO2485C	\$260	\$241	N.A.	N.A.	\$264	N.A.	N.A.	N.A.	N.A.	N.A.	N.A.	N.A.	N.A.
---------	-------	-------	------	------	-------	------	------	------	------	------	------	------	------

Indoor Cushion

CO2485B	\$260	\$241	\$249	\$254	\$264	\$271	\$295	\$312	\$315	\$415	\$368	\$ 588	\$ 633
---------	-------	-------	-------	-------	-------	-------	-------	-------	-------	-------	-------	--------	--------

COM/yds = ¾, COL/sq ft = 14

Arm Chair Cushions

Outdoor Cushion

CO2486C	\$265	\$254	N.A.	N.A.	\$281	N.A.	N.A.	N.A.	N.A.	N.A.	N.A.	N.A.	N.A.
---------	-------	-------	------	------	-------	------	------	------	------	------	------	------	------

Indoor Cushion

CO2486B	\$265	\$254	\$262	\$269	\$281	\$291	\$325	\$345	\$351	\$454	\$373	\$ 666	\$ 725
---------	-------	-------	-------	-------	-------	-------	-------	-------	-------	-------	-------	--------	--------

COM/yds = 1, COL/sq ft = 18

Chair Back Cushions

Outdoor Cushion

CO2480C	\$326	\$321	N.A.	N.A.	\$356	N.A.	N.A.	N.A.	N.A.	N.A.	N.A.	N.A.	N.A.
---------	-------	-------	------	------	-------	------	------	------	------	------	------	------	------

Indoor Cushion

CO2480B	\$326	\$321	\$332	\$340	\$356	\$370	\$410	\$438	\$496	\$551	\$434	\$ 903	\$ 992
---------	-------	-------	-------	-------	-------	-------	-------	-------	-------	-------	-------	--------	--------

COM/yds = 1¼, COL/sq ft = 28

Arm Chair Back Cushions

Outdoor Cushion

CO2481C	\$331	\$332	N.A.	N.A.	\$375	N.A.	N.A.	N.A.	N.A.	N.A.	N.A.	N.A.	N.A.
---------	-------	-------	------	------	-------	------	------	------	------	------	------	------	------

Indoor Cushion

CO2481B	\$331	\$332	\$345	\$354	\$375	\$391	\$439	\$472	\$542	\$591	\$439	\$1008	\$1115
---------	-------	-------	-------	-------	-------	-------	-------	-------	-------	-------	-------	--------	--------

COM/yds = 1½, COL/sq ft = 33

Lounge Cushions

Outdoor Cushion

CO2487C	\$336	\$337	N.A.	N.A.	\$380	N.A.	N.A.	N.A.	N.A.	N.A.	N.A.	N.A.	N.A.
---------	-------	-------	------	------	-------	------	------	------	------	------	------	------	------

Indoor Cushion

CO2487B	\$336	\$337	\$350	\$359	\$380	\$396	\$444	\$477	\$547	\$596	\$444	\$1013	\$1120
---------	-------	-------	-------	-------	-------	-------	-------	-------	-------	-------	-------	--------	--------

COM/yds = 1½, COL/sq ft = 33

► Specification Information, continued on next page

Emu Advanced Collection Emu Heaven – Seating *continued*

DESIGN JEAN-MARIE MASSAUD

► Specification Information, continued from previous page

Specification Information

Style Number	U.S. Base Prices											Leather Grades:		
	Fabric Grades:											COL	C	E
	COM	6	7	8	9	10	11	12	13	14				

Lounge Back Cushions

Outdoor Cushion

CO2489C	\$409	\$435	N.A.	N.A.	\$507	N.A.	N.A.	N.A.	N.A.	N.A.	N.A.	N.A.	N.A.
---------	-------	-------	------	------	-------	------	------	------	------	------	------	------	------

Indoor Cushion

CO2489B	\$409	\$435	\$458	\$474	\$507	\$533	\$615	\$669	\$786	\$809	\$517	\$1491	\$1669
---------	-------	-------	-------	-------	-------	-------	-------	-------	-------	-------	-------	--------	--------

COM/yds = 2½, COL/sq ft = 55

Lounge Pillows

Outdoor Pillow

CO2488C	\$196	\$177	N.A.	N.A.	\$200	N.A.	N.A.	N.A.	N.A.	N.A.	N.A.	N.A.	N.A.
---------	-------	-------	------	------	-------	------	------	------	------	------	------	------	------

Indoor Pillow

CO2488B	\$196	\$177	\$185	\$190	\$200	\$207	\$231	\$248	\$282	\$351	\$304	\$ 570	\$ 623
---------	-------	-------	-------	-------	-------	-------	-------	-------	-------	-------	-------	--------	--------

COM/yds = ¾, COL/sq ft = 17

Specification Information

Dimensions	Style	Quantity	U.S.
Dia.	H	Number	Base Price

Pouf/Side Table Base

17¾"	18½"	CO2495	1	\$499
------	------	--------	---	-------

Glass Top for use with Pouf

17¾"	CO2495V	1	\$232
------	---------	---	-------

Specification Information

Style Number	U.S. Base Prices											Leather Grades:		
	Fabric Grades:											COL	C	E
	COM	6	7	8	9	10	11	12	13	14				

Pouf Cushions

Outdoor Cushion

CO2495C	\$190	\$171	N.A.	N.A.	\$194	N.A.	N.A.	N.A.	N.A.	N.A.	N.A.	N.A.	N.A.
---------	-------	-------	------	------	-------	------	------	------	------	------	------	------	------

Indoor Cushion

CO2495B	\$190	\$171	\$179	\$184	\$194	\$201	\$225	\$242	\$276	\$345	\$298	\$564	\$617
---------	-------	-------	-------	-------	-------	-------	-------	-------	-------	-------	-------	-------	-------

COM/yds = ¾, COL/sq ft = 14

► Specification Information, continued on next page

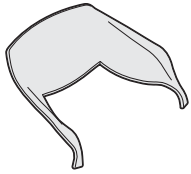

Overall: ¾"D x 34"W x 17½"H



Overall: 4¼"D x 17¼"W x 10½"H

Tip: Lounge pillow is for use with Heaven and Round Lounge chairs.



Tip: CO2495 pouf must be ordered with glass or cushion top, specified separately.

Tip: Cushions come in quantity of one.



18"Dia. x 2"H



For Canadian Pricing
Multiply U.S. Price by the Canadian price factor.
► See page 1 for details.

Emu Advanced Collection Emu Heaven – Seating

DESIGN JEAN-MARIE MASSAUD

► Specification Information, continued from previous page

Vases

Planter insert dimensions:
 Low: 36"H x 13½"Dia
 High: 33"H x 13½"Dia

Standard Includes	Required to Specify
-------------------	---------------------

- Vase: handcrafted woven steel mesh
- Finish: 4254 White outdoor grade powder coat paint
- Planter insert: white plastic

Style number

Specification Information			
---------------------------	--	--	--

Dimensions	Style	U.S.	
Dia.	H	Number	Price

Low Vase

23½"	40½"	CO2498	\$1618
------	------	--------	--------

High Vase

26¾"	64¼"	CO2497	\$2279
------	------	--------	--------

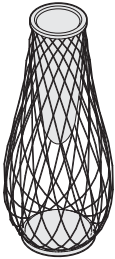
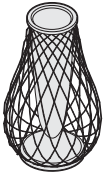

For Canadian Pricing
 Multiply U.S. Price by the
 Canadian price factor.
 ► See page 1 for details.

Emu Advanced Collection Emu Heaven – Tables

DESIGN JEAN-MARIE MASSAUD

Tip: Tables require glass top, specified separately.

Standard Includes	Required to Specify
<ul style="list-style-type: none"> • Frame: interwoven steel rods • Finish: outdoor grade powder coat paint • Glides: nylon • Top: tempered glass 	<ol style="list-style-type: none"> 1 Style number 2 Powder coat color for base 3 Glass top color number for glass top <p>▶ See <i>Coalesse Surface Materials Reference Guide</i>.</p>

Specification Information

Dimensions	Style	U.S.
Dia. H	Number	Price

Round Table Bases

For use with 31½" CO2493V Glass Top Below

27½"	29½"	CO2493	\$1093
------	------	--------	--------

For use with 47¼" CO2494V Glass Top Below

43⅓"	29½"	CO2494	\$2256
------	------	--------	--------

For use with 51" CO2499V Glass Top Below

43⅓"	29½"	CO2499	\$2538
------	------	--------	--------

Low Table Base

43⅓"	15¼"	CO2496	\$1695
------	------	--------	--------

Glass Tops

For use with 27½" CO2493 Round Table Base

31½"	¼"	CO2493V	\$ 422
------	----	---------	--------

For use with 43⅓" CO2494 Round or CO2496 Low Table Base

47¼"	¼"	CO2494V	\$ 640
------	----	---------	--------

For use with 43⅓" CO2499 Round Base

51"	¼"	CO2499V	\$ 809
-----	----	---------	--------



Top of base: 27½" Diameter
Bottom of base: 17¾" Diameter

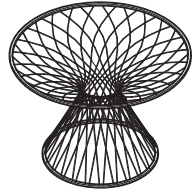

Top of base: 43⅓" Diameter
Bottom of base: 27½" Diameter

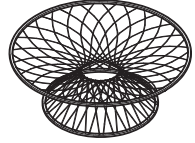

Top of base: 43⅓" Diameter
Bottom of base: 27½" Diameter

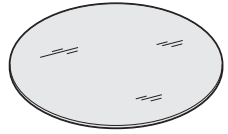
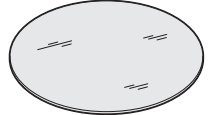

For Canadian Pricing
Multiply U.S. Price by the Canadian price factor.
▶ See page 1 for details.

Coalesse

Emu Advanced Collection

Emu Heaven – Tables

DESIGN JEAN-MARIE MASSAUD

Emu Advanced Collection Emu Ivy – Seating

DESIGN PAOLA NAVONE

Tip: COM outdoor fabric must be an approved outdoor fabric.

Tip: Cushions must be specified separately.

Tip: Fire code seating (FCS) is only available with certain upholstery fabric choices.

Tip: Side chair without arms stacks ten high. Side chair with arms stacks eight high.

Standard Includes	Required to Specify
<ul style="list-style-type: none"> • Frame: steel mesh and rod • Finish: outdoor grade powder coat paint • Glides: nylon • Cushions: fabric 	<ol style="list-style-type: none"> 1 Style number 2 Fabric color number for upholstery on cushions, if selected 3 Options, if selected (see below) <p>▶ See <i>Coalesse Surface Materials Reference Guide</i>.</p>

Options	U.S. Price	Required to Specify
Surface Materials Fire code seating <ul style="list-style-type: none"> • CAL 133 (applies to indoor cushions only) 	+\$113	Specify with CAL 133. ▶ See <i>Coalesse Surface Materials Reference Guide</i> .
Acrylic backer <ul style="list-style-type: none"> • Backer for indoor arm chair and side cushions • Backer for indoor sofa cushions 	+\$ 6 +\$ 8	Specify with acrylic backer. ▶ See <i>Coalesse Surface Materials Reference Guide</i> .

Specification Information					
Dimensions			Style	Quantity	U.S.
D	W	H	Number		Base Price

Side Chair without Arms

22½"	20½"	31"	C02581	4	\$1838
------	------	-----	--------	---	--------

Side Chair with Arms

22½"	22¾"	31"	C02582	4	\$2017
------	------	-----	--------	---	--------

Arm Chair

35½"	43¼"	26"	C02585	1	\$2852
------	------	-----	--------	---	--------

Sofa

35½"	75½"	26"	C02586	1	\$4518
------	------	-----	--------	---	--------

▶ Specification Information, continued on next page



Seat height: 17¾"



Seat height: 17¾"
Arm height: 26"

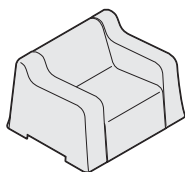

Seat height: 14½"
Seat depth: 21¼"
Arm height: 22½"

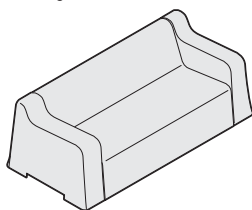

Seat height: 14½"
Seat depth: 21¼"
Arm height: 22½"

Emu Advanced Collection Emu Ivy – Seating

DESIGN PAOLA NAVONE

► Specification Information, continued from previous page

Specification Information

Dimensions			Style Number	Quantity	U.S. Base Price
D	W	H			

Pouf

20¾" Dia.	15¾"	CO2595	1	\$1000
-----------	------	--------	---	--------



Tip: Pouf has solid sheet metal top with a photovoltaic panel filled with five LED lights. LED lights collect and store solar energy to illuminate the under structure at night.

Tip: Pouf handle is always orange.

Tip: Cushions come in quantity of one.

Specification Information

Style Number	U.S. Base Prices												Leather Grades:		
	Fabric Grades:												COL	C	E
COM	6	7	8	9	10	11	12	13	14						

Arm Chair Cushions

Outdoor Cushion

CO2585C	\$445	\$ 459	N.A.	N.A.	\$ 515	N.A.	N.A.	N.A.	N.A.	N.A.	N.A.	N.A.	N.A.
---------	-------	--------	------	------	--------	------	------	------	------	------	------	------	------

Indoor Cushion

CO2585B	\$445	\$ 459	\$ 476	\$ 490	\$ 515	\$ 538	\$ 602	\$ 646	\$ 739	\$ 775	\$ 553	\$1325	\$1467
---------	-------	--------	--------	--------	--------	--------	--------	--------	--------	--------	--------	--------	--------

COM/yds = 1¾, COL/sq ft = 32

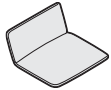

21"D x 24¼"W x 12½"H

Sofa Cushions

Outdoor Cushion

CO2586C	\$928	\$1021	N.A.	N.A.	\$1160	N.A.	N.A.	N.A.	N.A.	N.A.	N.A.	N.A.	N.A.
---------	-------	--------	------	------	--------	------	------	------	------	------	------	------	------

Indoor Cushion

CO2586B	\$928	\$1021	\$1062	\$1096	\$1160	\$1214	\$1377	\$1485	\$1678	\$1721	\$1036	\$3022	\$3379
---------	-------	--------	--------	--------	--------	--------	--------	--------	--------	--------	--------	--------	--------

COM/yds = 2¾, COL/sq ft = 50

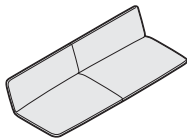

21"D x 56"W x 12½"H

Tip: Sofa cushion is two pieces.

Side Chair Cushions

Outdoor Cushion

CO2581C	\$281	\$ 262	N.A.	N.A.	\$ 285	N.A.	N.A.	N.A.	N.A.	N.A.	N.A.	N.A.	N.A.
---------	-------	--------	------	------	--------	------	------	------	------	------	------	------	------

Indoor Cushion

CO2581B	\$281	\$ 262	\$ 270	\$ 275	\$ 285	\$ 292	\$ 316	\$ 333	\$ 367	\$ 436	\$ 389	\$ 609	\$ 654
---------	-------	--------	--------	--------	--------	--------	--------	--------	--------	--------	--------	--------	--------



15"D x 15"W x ¾"H



For Canadian Pricing
Multiply U.S. Price by the Canadian price factor.

► See page 1 for details.

Emu Advanced Collection Emu Ivy – Tables

DESIGN PAOLA NAVONE

Tip: Tiles ship unattached. Six of the thirty-two tiles have design specified to allow for table top customization.

Tip: CO2592 contains a steel tube across the underneath of the top, ensuring top stability and structure.

Standard Includes	Required to Specify
<ul style="list-style-type: none"> • Top: solid sheet metal • Finish: outdoor grade powder coat paint • Legs: steel mesh and rod • Glides: nylon 	1 Style number 2 Powder coat color for table 3 Options, if selected (see below) ► See <i>Coalesse Surface Materials Reference Guide</i> .

Options	U.S. Price	Required to Specify
Surface Materials Tiles for rectangle side table <ul style="list-style-type: none"> • Blue fish tile • White bug tile 	+\$898 +\$898	Specify with fish tile. Specify with bug tile.

Specification Information				
Dimensions			Style	U.S.
D	W	H	Number	Base Price

Rectangular Side Table

29¼"	53¼"	11¾"	CO2589	\$1756
------	------	------	--------	--------

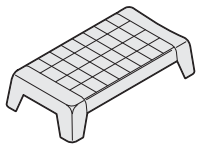

Square Side Table

47¼"	47¼"	12½"	CO2591	\$2814
------	------	------	--------	--------

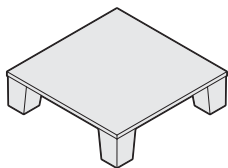

Rectangular Metal Top Table

44¾"	107¾"	29½"	CO2592	\$3906
------	-------	------	--------	--------

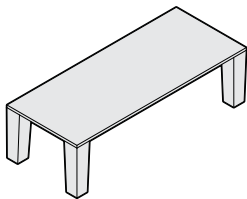

Rectangular Teak Top Table

44¾"	107¾"	29½"	CO2593	\$6070
------	-------	------	--------	--------

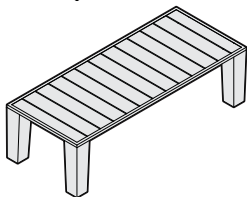

Square Tables

23½"	23½"	29½"	CO2596	\$1072
------	------	------	--------	--------

31½"	31½"	29½"	CO2597	\$1190
------	------	------	--------	--------

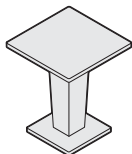

For Canadian Pricing
 Multiply U.S. Price by the Canadian price factor.
 ► See page 1 for details.

Emu Advanced Collection Emu Pattern – Seating

DESIGN ARIK LEVY

Tip: Legs will match frame finish.

Tip: Side chair stacks two high.

Standard Includes	Required to Specify
-------------------	---------------------

- | | |
|---|--|
| <ul style="list-style-type: none"> Painted frames: single sheet of molded steel Painted steel legs: painted aluminum base, to match frame Finish: outdoor grade powder coat paint Glides: nylon | <ul style="list-style-type: none"> 1 Style number 2 Powder coat color number for frame ▶ See <i>Coalesse Surface Materials Reference Guide</i>. |
|---|--|

Specification Information					
---------------------------	--	--	--	--	--

Dimensions			Style Number	Quantity	U.S. Price
D	W	H			

Arm Chair					
22"	24"	33½"	CO2511	2	\$1094



Seat height: 18"
Seat depth: 16½"



Seat height: 18"
Seat depth: 16½"

Armless Chair					
22"	24"	33½"	CO2510	2	\$1006

57"W Rectangular Bench					
15¾"	57½"	17¾"	CO2512	1	\$1007

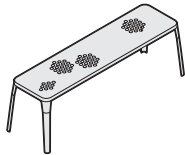

For Canadian Pricing
Multiply U.S. Price by the Canadian price factor.
▶ See page 1 for details.

Emu Advanced Collection Emu Pattern – Tables

DESIGN ARIK LEVY

Tip: Legs will be painted to match table.

Standard Includes	Required to Specify
<ul style="list-style-type: none"> • Painted table: single sheet of molded steel • Painted steel legs: painted to match table • Finish: outdoor grade powder coat paint • Glides: nylon 	1 Style number 2 Powder coat color number for table ▶ See <i>Coalesse Surface Materials Reference Guide</i> .

Specification Information

Dimensions	Style	U.S.
Dia. H	Number	Price

Small Round Table

31½"	29½"	C02518	\$ 813
------	------	--------	--------



Large Round Table

46"	29½"	C02520	\$1259
-----	------	--------	--------



Specification Information

Dimensions			Style	U.S.
D	W	H	Number	Price

Square Table

34¼"	34¼"	29½"	C02519	\$1148
------	------	------	--------	--------



For Canadian Pricing
 Multiply U.S. Price by the
 Canadian price factor.
 ▶ See page 1 for details.

Coalesse

Emu Advanced Collection

Emu Pattern – Tables

DESIGN ARIK LEVY

Emu Advanced Collection Emu Re-Trouvé – Seating

DESIGN PATRICIA URQUIOLA

Tip: COM outdoor fabric must be an approved outdoor fabric.

Tip: Cushions must be specified separately.

Tip: Fire code seating (FCS) is only available with certain upholstery fabric choices.

Standard Includes	Required to Specify
<ul style="list-style-type: none"> • Frame: hot-dipped steel rod, hand welded • Finish: outdoor grade powder coat paint • Seat: steel tube and ironed sheet metal • Glides: PVC • Cushions: fabric 	<ol style="list-style-type: none"> 1 Style number 2 Powder coat color for frame 3 Fabric color number for upholstery on cushions, if selected 4 Options, if selected (see below) <p>▶ See <i>Coalesse Surface Materials Reference Guide</i>.</p>

Options	U.S. Price	Required to Specify
Surface Materials Fire code seating <ul style="list-style-type: none"> • CAL 133 (applies to indoor cushions only) 	+\$113	Specify with <i>CAL 133</i> . ▶ See <i>Coalesse Surface Materials Reference Guide</i> .
Acrylic backer <ul style="list-style-type: none"> • Backer for indoor chair seat and pouf cushions only • Backer for chair seat and back indoor cushions only 	+\$ 8 +\$ 12	Specify with <i>acrylic backer</i> . ▶ See <i>Coalesse Surface Materials Reference Guide</i> .

Specification Information				
Dimensions	Style	U.S.		
D W H	Number	Base Price		

Midback Chair

23½" 26" 30¾" **CO2565MB** \$1228



Seat height: 17¾"



Seat height: 17¾"

Highback Chair

24" 30" 41¼" **CO2566HB** \$1452

Pouf

17¾" dia. 17¾" **CO2575** \$ 795



Tip: Cushions fit all chairs. Pouf requires seat cushion only.

Tip: Cushions come in quantity of one.

Specification Information														
Style Number	U.S. Base Prices											Leather Grades:		
	Fabric Grades:											COL	C	E
COM	6	7	8	9	10	11	12	13	14					

Chair Seat and Pouf Cushions

Outdoor Cushion

CO2575C \$229 \$218 N.A. N.A. \$245 N.A. N.A. N.A. N.A. N.A. N.A. N.A. N.A.

Indoor Cushion

CO2575B \$229 \$218 \$226 \$233 \$245 \$255 \$289 \$309 \$357 \$418 \$337 \$704 \$775

COM/yds = 1, COL/sq ft = 18

▶ Specification Information, continued on next page



18½" Dia. x 2¼" H



For Canadian Pricing
Multiply U.S. Price by the Canadian price factor.

▶ See page 1 for details.

Emu Advanced Collection Emu Re-Trouvé – Seating

DESIGN PATRICIA URQUIOLA

► Specification Information, continued from previous page

Specification Information

Style Number	U.S. Base Prices											Leather Grades:		
	Fabric Grades:											COL	C	E
COM	6	7	8	9	10	11	12	13	14					



20"D x 20½"W x 10"H

Chair Seat and Back Cushions

Outdoor Cushion

CO2566C	\$411	\$419	N.A.	N.A.	\$469	N.A.	N.A.	N.A.	N.A.	N.A.	N.A.	N.A.	N.A.
---------	-------	-------	------	------	-------	------	------	------	------	------	------	------	------

Indoor Cushion

CO2566B	\$411	\$419	\$433	\$445	\$469	\$486	\$543	\$582	\$665	\$706	\$519	\$1190	\$1314
---------	-------	-------	-------	-------	-------	-------	-------	-------	-------	-------	-------	--------	--------

COM/yds = 1¼, COL/sq ft = 27

Vase Frames and Vase Insert

Standard Includes	Required to Specify
-------------------	---------------------

- Frame: hot-dipped steel rod, hand welded
- Finish: outdoor grade powder coat paint
- Vase insert, if selected: white ceramic

- 1 Style number
 - 2 Powder coat color for frame
- See *Coalesse Surface Materials Reference Guide*.

Specification Information

Dimensions	Style	U.S.
Dia. H	Number	Price

Low Vase Frame

25½"	28"	CO2578	\$1579
------	-----	--------	--------

High Vase Frame

28¾"	41¼"	CO2577	\$1968
------	------	--------	--------

Vase Insert

24½"	14½"	CO2580	\$ 496
------	------	--------	--------



For Canadian Pricing
 Multiply U.S. Price by the
 Canadian price factor.
 ► See page 1 for details.

Emu Advanced Collection Emu Round – Seating

DESIGN CHRISTOPHE PILLET

Tip: Stool and lounge stacks four high. Chair stacks eight high.

Standard Includes	Required to Specify
<ul style="list-style-type: none"> • Frame: metal mesh seat, crafted using a deep drawing technique, welded to a tubular steel frame • Finish: outdoor grade powder coat paint • Glides: nylon 	1 Style number 2 Powder coat color for frame 3 Options, if selected (see below) ► See <i>Coalesse Surface Materials Reference Guide</i> .

Surface Materials	Options	U.S. Price	Required to Specify
	Fire code seating <ul style="list-style-type: none"> • CAL 133 (applies to indoor cushions only) 	+\$113	Specify with <i>CAL 133</i> . ► See <i>Coalesse Surface Materials Reference Guide</i> .
	Acrylic backer <ul style="list-style-type: none"> • Backer for indoor stool cushions only • Backer for indoor chair cushions only • Backer for indoor lounge cushions only • Backer for indoor pillow cushions only 	+\$ 10 +\$ 12 +\$ 21 +\$ 6	Specify with <i>acrylic backer</i> . Specify with <i>acrylic backer</i> . Specify with <i>acrylic backer</i> . Specify with <i>acrylic backer</i> . ► See <i>Coalesse Surface Materials Reference Guide</i> .

Specification Information

Dimensions			Style	Quantity	U.S. Base Price
D	W	H	Number		

Stool

20½"	22¾"	39¼"	CO2467	2	\$1185
------	------	------	--------	---	--------

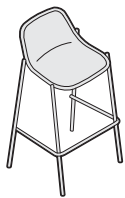

Seat height: 28"

Chair

23¼"	24¾"	32"	CO2465	4	\$1515
------	------	-----	--------	---	--------



Seat height: 17¾"

Arm Chair

23¼"	24¾"	32"	CO2466	4	\$1661
------	------	-----	--------	---	--------



Seat height: 17¾"
Arm height: 26"

► Specification Information, continued on next page



For Canadian Pricing
 Multiply U.S. Price by the Canadian price factor.
 ► See page 1 for details.

Emu Advanced Collection Emu Round – Seating

DESIGN CHRISTOPHE PILLET

Tip: All cushions come in quantity of one.

Tip: Cushions are one piece with a slit to allow for water drainage.



Seat height: 15"
Seat depth: 22¹/₆"



Overall: 3¹/₄"D x 22"W x 28"H



Overall: 3¹/₄"D x 18"W x 22¹/₂"H

Tip: Chair cushion for use on chair and arm chair.

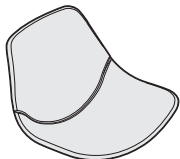

Overall: 3¹/₄"D x 34"W x 40"H



Overall: 4¹/₄"D x 17¹/₄"W x 10¹/₂"H

Tip: Lounge pillow is for use with Heaven and Round Lounge chairs.



For Canadian Pricing
Multiply U.S. Price by the Canadian price factor.

► See page 1 for details.

► Specification Information, continued from previous page

Specification Information

Dimensions			Style Number	Quantity	U.S. Base Price
D	W	H			

Lounge

34 ¹ / ₄ "	36 ¹ / ₄ "	33"	CO2469	2	\$1617
----------------------------------	----------------------------------	-----	--------	---	--------

Specification Information

Style Number	U.S. Prices												Leather Grades:		
	Fabric Grades:												COL	C	E
COM	6	7	8	9	10	11	12	13	14						

Stool Cushions

Outdoor Cushion

CO2467C	\$310	\$305	N.A.	N.A.	\$340	N.A.	N.A.	N.A.	N.A.	N.A.	N.A.	N.A.	N.A.
---------	-------	-------	------	------	-------	------	------	------	------	------	------	------	------

Indoor Cushion

CO2467B	\$310	\$305	\$316	\$324	\$340	\$354	\$394	\$422	\$480	\$535	\$418	\$ 887	\$ 976
---------	-------	-------	-------	-------	-------	-------	-------	-------	-------	-------	-------	--------	--------

COM/yds = 1¹/₄, COL/sq ft = 28

Chair Cushions

Outdoor Cushion

CO2465C	\$314	\$315	N.A.	N.A.	\$358	N.A.	N.A.	N.A.	N.A.	N.A.	N.A.	N.A.	N.A.
---------	-------	-------	------	------	-------	------	------	------	------	------	------	------	------

Indoor Cushion

CO2465B	\$314	\$315	\$328	\$337	\$358	\$374	\$422	\$455	\$525	\$574	\$422	\$ 991	\$1098
---------	-------	-------	-------	-------	-------	-------	-------	-------	-------	-------	-------	--------	--------

COM/yds = 1¹/₂, COL/sq ft = 33

Lounge Cushions and Pillows

Outdoor Cushion

CO2469C	\$405	\$431	N.A.	N.A.	\$503	N.A.	N.A.	N.A.	N.A.	N.A.	N.A.	N.A.	N.A.
---------	-------	-------	------	------	-------	------	------	------	------	------	------	------	------

Indoor Cushion

CO2469B	\$405	\$431	\$454	\$470	\$503	\$529	\$611	\$665	\$782	\$805	\$513	\$1487	\$1665
---------	-------	-------	-------	-------	-------	-------	-------	-------	-------	-------	-------	--------	--------

COM/yds = 2¹/₂, COL/sq ft = 55

Outdoor Pillow

CO2488C	\$196	\$177	N.A.	N.A.	\$200	N.A.	N.A.	N.A.	N.A.	N.A.	N.A.	N.A.	N.A.
---------	-------	-------	------	------	-------	------	------	------	------	------	------	------	------

Indoor Pillow

CO2488B	\$196	\$177	\$185	\$190	\$200	\$207	\$231	\$248	\$282	\$351	\$304	\$ 570	\$ 623
---------	-------	-------	-------	-------	-------	-------	-------	-------	-------	-------	-------	--------	--------

COM/yds = 3¹/₄, COL/sq ft = 17

Emu Advanced Collection Emu Round – Tables

DESIGN CHRISTOPHE PILLET

Standard Includes	Required to Specify
<ul style="list-style-type: none"> • Frame: table top and base are sheet metal with tubular steel mountings • Finish: outdoor grade powder coat paint • Glides: nylon 	1 Style number 2 Powder coat color for frame ▶ See <i>Coalesse Surface Materials Reference Guide</i> .

Specification Information

Dimensions			Style Number	U.S. Price
D	W	H		

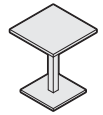

Square Tables

23½"	23½"	29½"	CO2472	\$ 623
27½"	27½"	29½"	CO2471	\$ 734
31½"	31½"	29½"	CO2473	\$ 779



Round Table

35½" dia.		29½"	CO2470	\$ 832
-----------	--	------	--------	--------

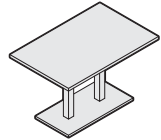

Rectangle Table

31½"	47½"	29½"	CO2474	\$1215
------	------	------	--------	--------

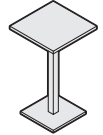

Counter Table

23½"	23½"	41¼"	CO2475	\$ 751
------	------	------	--------	--------

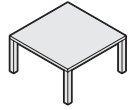

Side Tables

31½"	31½"	16½"	CO2477	\$ 539
27½"	39¼"	16½"	CO2478	\$ 592

For Canadian Pricing
 Multiply U.S. Price by the
 Canadian price factor.
 ▶ See page 1 for details.

Emu Advanced Collection Emu Shade

DESIGN CHRISTOPHE PILLET

Standard Includes	Required to Specify
<ul style="list-style-type: none"> • Frame: aluminum • Shade: acrylic fabric • Base: steel with outdoor grade powder coat paint - white 	1 Style number 2 Fabric color number for shade ▶ See <i>Coalesse Surface Materials Reference Guide</i> .

Specification Information

Dimensions			Style Number	U.S. Price
D	W	H		

Cantilever Umbrella

118"	118"	110¼"	CO2981	\$4383
------	------	-------	--------	--------

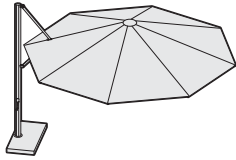

Tip: 265 lbs of weight ships with CO2981. These are four granite pieces with a steel handle.

Center Post Umbrella

78¾"	78¾"	95¼"	CO2980	\$1302
118"	118"	102¼"	CO2982	\$2579



Pentagonal Umbrella

130"	122"	102¼"	CO2984	\$2330
------	------	-------	--------	--------

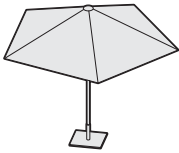

For Canadian Pricing
 Multiply U.S. Price by the Canadian price factor.
 ▶ See page 1 for details.

Emu Advanced Collection Emu Dolly

DESIGN CHRISTOPHE PILLET

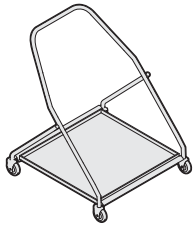

Tip: Dolly can be used with all styles of Emu stacking chairs.

Tip: Same quantity of chairs can be stacked on Dolly and floor. See individual product pages for stacking information.

Standard Includes	Required to Specify
-------------------	---------------------

- Dolly: steel

Style number

Specification Information				
Dimensions			Style Number	U.S. Price
D	W	H		

29½"	34¼"	39¼"	CODOLLY017	\$882
------	------	------	------------	-------

For Canadian Pricing
 Multiply U.S. Price by the
 Canadian price factor.
 ▶ See page 1 for details.

Resources



Style Number Index

394

Style Number Index

Style Number	Page	Description	Style Number	Page	Description
100-T1	314	Bob Round Occasional Table	126200S	267	Kart Nesting Chair
100-T2	314	Bob Round Occasional Table	126200SST	269	Kart Stool on Casters
100-T3	314	Bob Round Occasional Table	126200ST	269	Kart Stool on Casters
100-T4	314	Bob Round Occasional Table	126201	267	Kart Nesting Chair
105-T1	315	Bob Table	126201S	267	Kart Nesting Chair
105-T2	315	Bob Table	126201SST	269	Kart Stool on Casters
105-T3	315	Bob Table	126201ST	269	Kart Stool on Casters
105-T4	315	Bob Table	126211	271	Kart Stacking Chair w/Arms
1100TAL	143	Detour Lounge Chair	126211S	271	Kart Stacking Chair w/Arms
1100TAR	143	Detour Lounge Chair	126211SST	270	Kart Café Four-Leg Stool w/Arms
1101C	140	Detour Lounge Chair	126211ST	270	Kart Café Four-Leg Stool w/Arms
1101CAA	141	Detour Lounge Chair	126900	267	Kart Accessory
1101CAX	141	Detour Lounge Chair	127100J	274	Jury Base
1101CXA	141	Detour Lounge Chair	127101J	274	Jury Base
1101G	140	Detour Lounge Chair	127200J	274	Jury Base
1101GAA	141	Detour Lounge Chair	127200SJ	274	Jury Base
1101GAX	141	Detour Lounge Chair	127201J	274	Jury Base
1101GXA	141	Detour Lounge Chair	127201SJ	274	Jury Base
1102C	141	Detour Lounge Chair	128100J	275	Jury Base
1102CAA	142	Detour Lounge Chair	128101J	275	Jury Base
1102CAX	141	Detour Lounge Chair	128200J	275	Jury Base
1102CXA	141	Detour Lounge Chair	128200SJ	275	Jury Base
1102G	141	Detour Lounge Chair	128201J	275	Jury Base
1102GAA	142	Detour Lounge Chair	128201SJ	275	Jury Base
1102GAX	141	Detour Lounge Chair	14-10L	151	Evaneau Asymmetrical
1102GXA	141	Detour Lounge Chair	14-10R	151	Evaneau Asymmetrical
1103C	142	Detour Lounge Chair	14-20	151	Evaneau Two-Seat Sofa
1103CAA	142	Detour Lounge Chair	14-30	151	Evaneau Three-Seat Sofa
1103CAX	142	Detour Lounge Chair	14-5	151	Evaneau Single Arm Chair
1103CXA	142	Detour Lounge Chair	14-6	152	Evaneau Round Back Cushion
1103G	142	Detour Lounge Chair	14-7	152	Evaneau Round Back Cushion
1103GAA	142	Detour Lounge Chair	14-A	152	Evaneau Arm Pillow
1103GAX	142	Detour Lounge Chair	14-B	152	Evaneau Arm Bolster
1103GXA	142	Detour Lounge Chair	14-C	150	Evaneau Chair
1104C	144	Detour Ottoman	14-HHR	151	Evaneau Ottoman
1104G	144	Detour Ottoman	14-HHS	152	Evaneau Ottoman
112101	281	Rocky Four-Star Nesting Chair with Arms	14-HLR	151	Evaneau Ottoman
112201	281	Rocky Four-Star Nesting Chair with Arms	1404M	288	Switch Counter-Height Stool
112201S	281	Rocky Four-Star Nesting Chair with Arms	1404PC	288	Switch Counter-Height Stool
112301	282	Rocky Five-Star Base Chair	1405M	288	Switch Bar-Height Stool
112301J	284	Jury Base	1405PC	288	Switch Bar-Height Stool
112301ST	283	Rocky Five-Star Base Stool	1500M	286	Switch Guest Armless Chair
112401	282	Rocky Five-Star Base Chair	1500PC	286	Switch Guest Armless Chair
112401J	284	Jury Base	1510M	286	Switch Guest Arm Chair
112401S	282	Rocky Five-Star Base Chair	1510PC	286	Switch Guest Arm Chair
112401SJ	284	Jury Base	1519M	286	Switch Guest Lowback Sledbase
112401SST	283	Rocky Five-Star Base Stool	1519PC	286	Switch Guest Lowback Sledbase
112401ST	283	Rocky Five-Star Base Stool	1529M	287	Switch Guest Highback Sledbase
126100	266	Kart Nesting Chair	1529PC	287	Switch Guest Highback Sledbase
126100ST	268	Kart Stools on Casters	1810M	240	Capa Chair
126101	266	Kart Nesting Chair	1810PC	240	Capa Chair
126101ST	268	Kart Stool on Casters	192020F	308	Avon Table
126111	271	Kart Stacking Chair w/Arms	192020W	308	Avon Table
126111ST	270	Kart Cafe Four-Leg Stool w/Arms	192030F	308	Avon Table
126200	267	Kart Nesting Chair	192030W	308	Avon Table

Style Number Index

Style Number	Page	Description	Style Number	Page	Description
192448F	308	Avon Table	318-3	65	Astor Three-Seat Sofa
192448W	308	Avon Table	318-A	65	Astor Pillow
193030F	308	Avon Table	3500	244	Enea Arm Chair
193030W	308	Avon Table	3500S	246	Enea Armless
193636F	308	Avon Table	3501	245	Enea Arm Chair
193636W	308	Avon Table	3501S	247	Enea Armless
212020F	309	Avon Table	3502	245	Enea Arm Chair
212020W	309	Avon Table	3502S	247	Enea Armless
213030F	309	Avon Table	3503	245	Enea Arm Chair
213030W	309	Avon Table	3503S	247	Enea Armless
213636F	309	Avon Table	3510	248	Enea Bar-Height Stool w/Arms
213636W	309	Avon Table	3510S	250	Enea Armless Bar-Height Stool
216	103	Bob Lounge Swivel Chair	3511	249	Enea Bar-Height Stool w/Arms
221	103	Bob Lounge Chair w/Headrest	3511S	251	Enea Armless Bar-Height Stool
221-H	103, 239	Bob Ottoman	3512	249	Enea Bar-Height Stool w/Arms
231	239	Bob Guest Chair	3512S	251	Enea Armless Bar-Height Stool
240	198	Swathmore Chair Wood Leg	3513	249	Enea Bar-Height Stool w/Arms
240-2	198	Swathmore 2 St Sofa Wood Leg	3513S	251	Enea Armless Bar-Height Stool
240-3	199	Swathmore 3 St Sofa Wood Leg	356	148	Donovan Chair
241	200	Swathmore Chair Wood Base	356-2	148	Donovan Two-Seat Sofa
241-2	200	Swathmore 2 St Sofa Wood Base	356-3	149	Donovan Three-Seat Sofa
241-3	201	Swathmore 3 St Sofa Wood Base	36-1818HF	333	Donovan Square
243	202	Swathmore Grande Chair Wd Leg	36-1818HGL	333	Donovan Square
243-2	203	Swathmore Grande 2 St Wd Leg	36-1818HGR	333	Donovan Square
243-3	203	Swathmore Grande 3 St Wd Leg	36-1818HW	333	Donovan Square
243B-30	203	Swathmore Grande Bariatric Chair	36-18RDHF	332	Donovan Round
243B-40	203	Swathmore Grande Bariatric Chair	36-18RDHGL	332	Donovan Round
243MTL	206	Swathmore Grande Mobile	36-18RDHGR	332	Donovan Round
243MTR	206	Swathmore Grande Mobile	36-18RDHW	332	Donovan Round
244	204	Swathmore Grande Wd Base	36-1943ELF	333	Donovan Elliptical
244-2	204	Swathmore Grande 2 St Wd Base	36-1943ELGL	333	Donovan Elliptical
244-3	205	Swathmore Grande 3 St Wd Base	36-1943ELGR	333	Donovan Elliptical
2540-1	276	Kathryn Wood with Open Back	36-1943ELW	333	Donovan Elliptical
2542-1	276	Kathryn Wood/Uph with Panel Back	36-2424HF	333	Donovan Square
2547-1	277	Kathryn Fully Uphol Back	36-2424HGL	333	Donovan Square
2547-1RIBD	277	Kathryn Fully Uphol Back w/Ribbed uph	36-2424HGR	333	Donovan Square
263	176	Pasio Chair	36-2424HW	333	Donovan Square
263-2	176	Pasio Two Seat Sofa	36-2424LF	333	Donovan Square
263-3	177	Pasio Three Seat Sofa	36-2424LGL	333	Donovan Square
263A	177	Pasio Pillow	36-2424LGR	333	Donovan Square
284	154	Herren Chair	36-2424LW	333	Donovan Square
284-2	154	Herren Two-Seat Sofa	36-24RDHF	332	Donovan Round
284-3	154	Herren Three-Seat Sofa	36-24RDHGL	332	Donovan Round
287	124	Club/Club Mobile Chair	36-24RDHGR	332	Donovan Round
287-2	124	Club/Club Mobile Two-Seat Sofa	36-24RDHW	332	Donovan Round
287-3	125	Club/Club Mobile Three-Seat Sofa	36-24RDLF	332	Donovan Round
287MTL	125	Club/Club Mobile Chair	36-24RDLGL	332	Donovan Round
287MTR	125	Club/Club Mobile Chair	36-24RDLGR	332	Donovan Round
289	126	Club Grande Chair	36-24RDLW	332	Donovan Round
289-2	126	Club Grande Loveseat	36-31RDLF	332	Donovan Round
289-3	127	Club Grande Sofa	36-31RDLGL	332	Donovan Round
289B-30	127	Club Grande Bariatric Chair	36-31RDLGR	332	Donovan Round
289B-40	127	Club Grande Bariatric Chair	36-31RDLW	332	Donovan Round
318	64	Astor Chair	37-1818HF	347	Ginger Square
318-2	64	Astor Two-Seat Sofa	37-1818HGL	347	Ginger Square

Style Number Index *continued*

Style Number	Page	Description	Style Number	Page	Description
37-1818HGR	347	Ginger Square	43-T174812	355	Sidewalk Table
37-1818HW	347	Ginger Square	43-T174817	354	Sidewalk Table
37-18RDHF	346	Ginger Round	43-T174822	355	Sidewalk Table
37-18RDHGL	346	Ginger Round	43-T174830	355	Sidewalk Table
37-18RDHGR	346	Ginger Round	43-T222222	354	Sidewalk Table
37-18RDHW	346	Ginger Round	43-T363612	356	Sidewalk Table
37-1943ELF	347	Ginger Elliptical	43-T363617	354	Sidewalk Table
37-1943ELGL	347	Ginger Elliptical	43-T363622	355	Sidewalk Table
37-1943ELGR	347	Ginger Elliptical	430	188	Sidewalk Collaborative Chair
37-1943ELW	347	Ginger Elliptical	430-2	189	Sidewalk Collaborative Two-Seat
37-2424HF	347	Ginger Square	430-B1724	190	Sidewalk Bench
37-2424HGL	347	Ginger Square	430-B1736	190	Sidewalk Bench
37-2424HGR	347	Ginger Square	430-B1748	190	Sidewalk Bench
37-2424HW	347	Ginger Square	430-H1717	189	Sidewalk Collaborative Ottoman
37-2424LF	347	Ginger Square	430-H1720	189	Sidewalk Collaborative Ottoman
37-2424LGL	347	Ginger Square	430-H2026	189	Sidewalk Collaborative Ottoman
37-2424LGR	347	Ginger Square	430-H3636	190	Sidewalk Ottoman
37-2424LW	347	Ginger Square	44-T164817	350	Passerelle Table
37-24RDHF	346	Ginger Round	44-T164830	350	Passerelle
37-24RDHGL	346	Ginger Round	44-T242417	350	Passerelle Table
37-24RDHGR	346	Ginger Round	44-T242421	350	Passerelle Table
37-24RDHW	346	Ginger Round	440-2WB	178	Passerelle Loveseat
37-24RDLF	346	Ginger Round	440-3WB	179	Passerelle Sofa
37-24RDLGL	346	Ginger Round	440-B	179	Passerelle Arm Bolster
37-24RDLGR	346	Ginger Round	440-B2060WB	181	Passerelle Bench
37-24RDLW	346	Ginger Round	440-B3060WB	181	Passerelle Bench
37-31RDLF	346	Ginger Round	440-B4040WB	181	Passerelle Bench
37-31RDLGL	346	Ginger Round	440-H1717WB	180	Passerelle Ottoman
37-31RDLGR	346	Ginger Round	440-H2026WB	180	Passerelle Ottoman
37-31RDLW	346	Ginger Round	440-H3636WB	180	Passerelle Ottoman
385	212	Thoughtful Lounge Chair	440-WB	178	Passerelle Chair
385-60	212	Thoughtful Small Sofa	444	184	Sidewalk Lowback Chair
385-70	213	Thoughtful Medium Sofa	444-2	185	Sidewalk Two-Seat
385-80	213	Thoughtful Long Sofa	444M	185	Sidewalk Lowback Chair w/Tablet
385-H	213	Thoughtful Ottoman	446	185	Sidewalk Highback Chair
39-2424	364	Switch Square	446M	185	Sidewalk Mobile Highback Chair w/Tablet
39-2442	364	Switch Rectangle	45-T1300H	119, 328	Circa Freestanding Table
39-3636	364	Switch Square	45-T1300HER	120	Circa Ganging Table
391	208	Switch Chair	45-T1300HG	120	Circa Ganging Table
391-2	208	Switch Two-Seat	45-T1300L	119, 328	Circa Freestanding Table
391-3	209	Switch Three-Seat	45-T1300LER	121	Circa Ganging Table
391-4	209	Switch Two-Seat w/Extensions	45-T1300LG	121	Circa Ganging Table
391-B	209	Switch Arm Bolster	45-T1815H	119, 328	Circa Freestanding Table
43-S174820	357	Sidewalk Credenza	45-T1815HER	121	Circa Ganging Table
43-S174833	357	Sidewalk Credenza	45-T1815HG	120	Circa Ganging Table
43-ST171717	357	Sidewalk Storage Table	45-T1815L	119, 328	Circa Freestanding Table
43-ST172017	357	Sidewalk Storage Table	45-T1815LER	120	Circa Ganging Table
43-T171717	354	Sidewalk Table	45-T1815LG	120	Circa Ganging Table
43-T171730	355	Sidewalk Table	45-T28HER	121	Circa Ganging Table
43-T172412	356	Sidewalk Table	45-T3730H	118, 327	Circa Freestanding Table
43-T172417	354	Sidewalk Table	45-T3730HER	122	Circa Ganging Table
43-T172422	355	Sidewalk Table	45-T3730HG	122	Circa Ganging Table
43-T173612	356	Sidewalk Table	45-T3730L	118, 327	Circa Freestanding Table
43-T173617	354	Sidewalk Table	45-T3730LER	121	Circa Ganging Table
43-T173622	355	Sidewalk Table	45-T3730LG	121	Circa Ganging Table

Style Number Index

Style Number	Page	Description	Style Number	Page	Description
45-T42RD	119, 328	Circa Freestanding Table	473-3MAPLE	133	Coupe Sofa
45-T7460HP	118, 327	Circa Freestanding Table	473-3WALNUT	133	Coupe Sofa
45-T7460HPER	122	Circa Ganging Table	473MAPLE	132	Coupe Chair
45-T7460HPG	122	Circa Ganging Table	473WALNUT	132	Coupe Chair
451-2500	112	Circa Straight Seat Chair	476	130	Coupe Grande Chair
451-3730FI	111	Circa 30° Inside Wedge Armless Seat	476-2	131	Coupe Grande Loveseat
451-3730FO	110	Circa 30° Outside Wedge Seat	476-3	131	Coupe Grande Sofa
451-5000	112	Circa Straight Loveseat	476M	131	Coupe Grande Chair
451-7460FI	111	Circa 60° Inside Wedge Loveseat	49-SFTH15A	359	Soft Leaf
451-7460FO	111	Circa 60° Outside Wedge Loveseat	49-SFTH17B	359	Soft Leaf
451-A1800ER	114	Circa Straight Armrest	49-SFTH21C	358	Soft Leaf
451-A1800G	114	Circa Straight Armrest	49-SFTH23D	358	Soft Leaf
451-A1815FIER	114	Circa 15° Inside Armrest	49-SFTH23E	358	Soft Leaf
451-A1815FIG	114	Circa 15° Inside Armrest	490-B35HRZ	183	Ripple Bench
451-A1815FOER	115	Circa 15° Outside Armrest	490-B35VRT	182	Little Ripple Wave Bench
451-A1815FOG	115	Circa 15° Outside Armrest	490-B96HRZ	182	Ripple Flat Seat Bench
451-A3730FIER	116	Circa 30° Inside Armrest	490-B96VRT	182	Ripple Wave Bench
451-A3730FIG	116	Circa 30° Inside Armrest	50-2020HF	363	Swathmore Plus Beveled
451-A3730FOER	117	Circa 30° Outside Armrest	50-2020HGL	363	Swathmore Plus Beveled
451-A3730FOG	117	Circa 30° Outside Armrest	50-2020HGR	363	Swathmore Plus Beveled
451-B42RD	117	Circa Round Ottoman	50-2020HW	363	Swathmore Plus Beveled
451-B5000	112	Circa Straight Bench	50-2020LF	362	Swathmore Plus Beveled
451-B7460FI	111	Circa 60° Inside Wedge Bench	50-2020LGL	362	Swathmore Plus Beveled
451-B7460FO	111	Circa 60° Outside Wedge Bench	50-2020LGR	362	Swathmore Plus Beveled
451-GANGPKG	112, 115	Circa Ganging Kit	50-2020LW	362	Swathmore Plus Beveled
46-T1	69, 310	Await Freestanding Table	50-2030LF	362	Swathmore Plus Beveled
46-T2	69, 310	Await Freestanding Table	50-2030LGL	362	Swathmore Plus Beveled
460-3	67	Await Modular Three-Seat Sofa	50-2030LGR	362	Swathmore Plus Beveled
460-4	67	Await Modular Four-Seat Sofa	50-2030LW	362	Swathmore Plus Beveled
460-4B	67	Await Modular Four-Seat Bench	50-2448LF	362	Swathmore Plus Beveled
460-GANGPKG	68	Ganging Kit	50-2448LGL	362	Swathmore Plus Beveled
460-H	67	Await Modular Ottoman	50-2448LGR	362	Swathmore Plus Beveled
460-SE22	69, 310	Await Connector Table	50-2448LW	362	Swathmore Plus Beveled
460-SE22PD	69, 310	Await Connector Table	50-3030HF	363	Swathmore Plus Beveled
460-SE30	69, 310	Await Connector Table	50-3030HGL	363	Swathmore Plus Beveled
460-SE30PD	69, 310	Await Connector Table	50-3030HGR	363	Swathmore Plus Beveled
460-SE44	69, 310	Await Connector Table	50-3030HW	363	Swathmore Plus Beveled
460-SE44PD	69, 310	Await Connector Table	50-3030LF	362	Swathmore Plus Beveled
461-1B	68	Await Connector Bench	50-3030LGL	362	Swathmore Plus Beveled
461-2B	68	Await Connector Bench	50-3030LGR	362	Swathmore Plus Beveled
461-3B	68	Await Connector Bench	50-3030LW	362	Swathmore Plus Beveled
47-T1326C	331	Diekman	50-3636HF	363	Swathmore Plus Beveled
47-T1623A	331	Diekman	50-3636HGL	363	Swathmore Plus Beveled
47-T1623B	331	Diekman Wood	50-3636HGR	363	Swathmore Plus Beveled
47-T17ELG	331	Diekman	50-3636HW	363	Swathmore Plus Beveled
47-T17RG1	331	Diekman	50-3636LF	362	Swathmore Plus Beveled
47-T2217E	331	Diekman	50-3636LGL	362	Swathmore Plus Beveled
47-T23EL	331	Diekman	50-3636LGR	362	Swathmore Plus Beveled
47-T2617D	331	Diekman	50-3636LW	362	Swathmore Plus Beveled
470	128	Coupe Chair	70-A-SMM	369	Tree
470-2	128	Coupe Loveseat	70-B-SMM	369	Tree
470-3	129	Coupe Sofa	70-C-TPM	369	Tree
470-H	129	Coupe Ottoman	70-D-TPM	369	Tree
473-2MAPLE	132	Coupe Loveseat	70-E-PTM	368	Tree
473-2WALNUT	132	Coupe Loveseat	70-EEG1	368	Tree

Style Number Index continued

Style Number	Page	Description	Style Number	Page	Description
70-EFG1	368	Tree	910UEAR	60	Archipelago Upholstered Arm
70-F-LPT	369	Tree	910UIA	60	Archipelago Lounge Chair
70-F-TPM	369	Tree	910XC	59	Archipelago Lounge Chair
72-2020H	316	Calm Table Sq Top	910XG	59	Archipelago Lounge Chair
72-2020L	316	Calm Table Sq Top	911	60	Archipelago Ottoman
72-2026HR	318	Calm Table Rect Top	990	301	LaCosta Sport Sled Base
72-2026HV	317	Calm Table Oval Top	991PS	301	La Costa Sport Conference Chair
72-2026LR	318	Calm Table Rect Top	991PW	301	La Costa Sport Conference Chair
72-2026LV	317	Calm Table Oval Top	991SS	301	La Costa Sport Conference Chair
72-2038LR	318	Calm Table Rect Top	991SW	301	La Costa Sport Conference Chair
72-2142LR	318	Calm Table Rect Top	992PS	301	La Costa Sport Mid Back Chair
72-2242LV	317	Calm Table Oval Top	992PW	301	La Costa Sport Mid Back Chair
72-2424H	316	Calm Table Sq Top	992SS	301	La Costa Sport Mid Back Chair
72-2424L	316	Calm Table Sq Top	992SW	301	La Costa Sport Mid Back Chair
72-3636L	316	Calm Table Sq Top	993PS	301	La Costa Sport High Back Chair
72-4242L	316	Calm Table Sq Top	993PW	301	La Costa Sport High Back Chair
793390	272	Kart Stack Dolly	993SS	301	La Costa Sport High Back Chair
795	296	Chord Conference Chair	993SW	301	La Costa Sport High Back Chair
795AU	296	Chord Conference Chair	996PS	299	La Costa Couture Conf Chair
796	297	Chord Midback Chair	996PW	299	La Costa Couture Conf Chair
796-P	297	Chord Midback Chair	996SS	299	La Costa Couture Conf Chair
796-PAU	297	Chord Midback Chair	996SW	299	La Costa Couture Conf Chair
796AU	297	Chord Midback Chair	997PS	299	La Costa Couture Mid Back Chair
797	297	Chord High Back Chair	997PW	299	La Costa Couture Mid Back Chair
797AU	297	Chord Midback Chair	997SS	299	La Costa Couture Mid Back Chair
798	297	Chord High Back Chair	997SW	299	La Costa Couture Mid Back Chair
798-P	297	Chord High Back Chair	998PS	299	La Costa Couture High Back Chair
798-PAU	297	Chord Midback Chair	998PW	299	La Costa Couture High Back Chair
798AU	297	Chord Midback Chair	998SS	299	La Costa Couture High Back Chair
852PS	302	Maestro Low Back Chair	998SW	299	La Costa Couture High Back Chair
852PW	302	Maestro Low Back Chair	BATRAY	97	Bix Service Tray
852SS	302	Maestro Low Back Chair	BB48	90	Bix Bench
852SW	302	Maestro Low Back Chair	BB72	90	Bix Bench
853PS	302	Maestro Medium Back Chair	BBS48	90	Bix Bench
853PW	302	Maestro Medium Back Chair	BBS72	90	Bix Bench
853SS	302	Maestro Medium Back Chair	BL26AA	82	Bix Lounge Chair with Arms
853SW	302	Maestro Medium Back Chair	BL26XX	82	Bix Lounge Chair
859PS	303	Maestro High Back Chair	BLB26XX	82	Bix Lounge Chair with Screen
859PW	303	Maestro High Back Chair	BLD26AA	83	Bix Sled Lounge with Arms
859SS	303	Maestro High Back Chair	BLD26TX	83	Bix Sled Lounge Tablet Arm
859SW	303	Maestro High Back Chair	BLD26XT	83	Bix Sled Lounge Tablet Arm
9014S	240, 245, 247	Stacking Dolly	BLD26XX	83	Bix Sled Lounge
910C	58	Archipelago Lounge Chair	BP72TX	92	Bix Podium
910EAL	59	Archipelago Lounge Chair	BP72XT	93	Bix Podium
910EAR	59	Archipelago Lounge Chair	BPP72TX	93	Bix Podium
910G	58	Archipelago Lounge Chair	BPP72XT	93	Bix Podium
910IA	59	Archipelago Lounge Chair	BSC30LA	84	Bix Sectional Seating
910LC	59	Archipelago Lounge Chair	BSC30LB	84	Bix Sectional Seating
910LG	59	Archipelago Lounge Chair	BSC30RA	85	Bix Sectional Seating
910RC	59	Archipelago Lounge Chair	BSC30RB	85	Bix Sectional Seating
910RG	59	Archipelago Lounge Chair	BSCB30LA	85	Bix Sectional Seating
910TAL	60	Archipelago Tablet Arm	BSCB30LB	85	Bix Sectional Seating
910TAR	60	Archipelago Tablet Arm	BSCB30RA	85	Bix Sectional Seating
910UEAL	60	Archipelago Lounge Chair	BSCB30RB	85	Bix Sectional Seating
			BSE54LA	86	Bix Sectional Seating

Style Number Index

Style Number	Page	Description	Style Number	Page	Description
BSE54LX	86	Bix Sectional Seating	CH07ASH	104	CH07 Shell Chair
BSE54RA	86	Bix Sectional Seating	CH07BEECH	104	CH07 Shell Chair
BSE54RX	86	Bix Sectional Seating	CH07OAK	104	CH07 Shell Chair
BSEB54LA	86	Bix Sectional Seating	CH07WALNUT	104	CH07 Shell Chair
BSEB54LX	86	Bix Sectional Seating	CH101	107	CH100 Series Chair
BSEB54RA	86	Bix Sectional Seating	CH101L	107	CH100 Series Chair
BSEB54RX	86	Bix Sectional Seating	CH103	107	CH100 Series Sofa
BSS48AA	87	Bix Sectional Seating	CH103L	107	CH100 Series Sofa
BSS48AX	87	Bix Sectional Seating	CH108	325	CH100 Series Table
BSS48XA	87	Bix Sectional Seating	CH20BEECH	242	CH20 Elbow Chair
BSS48XX	87	Bix Sectional Seating	CH20OAK	242	CH20 Elbow Chair
BSS72AA	88	Bix Sectional seating	CH24ASH	241	CH24 Wishbone Chair
BSS72AX	88	Bix Sectional seating	CH24BEECH	241	CH24 Wishbone Chair
BSS72XA	88	Bix Sectional seating	CH24BLKOAK	241	CH24 Wishbone Chair
BSS72XX	88	Bix Sectional seating	CH24CHERRY	241	CH24 Wishbone Chair
BSSB48AX	87	Bix Sectional Seating	CH24OAK	241	CH24 Wishbone Chair
BSSB48XA	87	Bix Sectional Seating	CH24WALNUT	241	CH24 Wishbone Chair
BSSB48XX	87	Bix Sectional Seating	CH25OAK	105	CH25 Paddle Chair
BSSB72AX	88	Bix Sectional seating	CH327ASH	326	CH327 Dining Table
BSSB72XA	88	Bix Sectional seating	CH327OAK	326	CH327 Dining Table
BSSB72XX	88	Bix Sectional seating	CH327WALNUT	326	CH327 Dining Table
BTB2226	98	Bix Bridge Table	CH401	108	CH401 Airport Chair
BTB2226U	98	Bix Bridge Table	CH445	109	CH445 Wing Chair
BTB2626	99	Bix Bridge Table	CH446	109	CH445 Ottoman
BTB2626U	99	Bix Bridge Table	CH44ASH	106	CH44 Ladderback Chair
BTBS2226	99	Bix Bridge Table	CH44OAK	106	CH44 Ladderback Chair
BTBS2226U	99	Bix Bridge Table	CH53OAK	243	CH53 Stool
BTBS2626	99	Bix Bridge Table	CO200G	238, 295	Bindu Low Back Guest/Side Chair
BTBS2626U	99	Bix Bridge Table	CO2465	388	Emu Round Chair
BTC20001	100, 313	Bix Occasional Table	CO2465B	389	Emu Round Stool Cushion
BTC24241	100, 313	Bix Occasional Table	CO2465C	389	Emu Round Chair Cushion
BTC24241U	100, 313	Bix Occasional Table	CO2466	388	Emu Round Arm Chair
BTC24481	100, 313	Bix Occasional Table	CO2467	388	Emu Round Stool
BTC24481U	100, 313	Bix Occasional Table	CO2467B	389	Emu Round Stool Cushion
BTC24721	100, 313	Bix Occasional Table	CO2467C	389	Emu Round Stool Cushion
BTC24721U	100, 313	Bix Occasional Table	CO2469	389	Emu Round Lounge
BTC28001	100, 313	Bix Occasional Table	CO2469B	389	Emu Round Lounge Cushion
BTC28001U	100, 313	Bix Occasional Table	CO2469C	389	Emu Round Lounge Cushion
BTS1700	102, 312	Bix Side Table	CO2470	390	Emu Round Table
BTW20003	101	Bix Work-Booth Table	CO2471	390	Emu Square Table
BTW28003	101	Bix Work-Booth Table	CO2472	390	Emu Square Table
BTW28003U	101	Bix Work-Booth Table	CO2473	390	Emu Square Table
BTW36483	101	Bix Work-Booth Table	CO2474	390	Emu Rectangle Table
BTW36483U	101	Bix Work-Booth Table	CO2475	390	Emu Counter Table
BTW36723	101	Bix Work-Booth Table	CO2477	390	Emu Side Table
BTW36723U	101	Bix Work-Booth Table	CO2478	390	Emu Side Table
CH0080100ASH	324	Sofa Table	CO2480B	375	Emu Heaven Chair Back Cushion
CH0080100OAK	324	Sofa Table	CO2480C	375	Emu Heaven Chair Back Cushion
CH0080100WAL	324	CH008 Sofa Table	CO2481B	375	Emu Heaven Arm Chair Back Cushion
CH008078ASH	324	Sofa Table	CO2481C	375	Emu Heaven Arm Chair Back Cushion
CH008078OAK	324	Sofa Table	CO2485	374	Emu Heaven Chair
CH008078WAL	324	CH008 Sofa Table	CO2485B	375	Emu Heaven Indoor Cushion
CH008088ASH	324	Sofa Table	CO2485C	375	Emu Heaven Outdoor Cushion
CH008088OAK	324	Sofa Table	CO2486	374	Emu Heaven Arm Chair
CH008088WAL	324	CH008 Sofa Table	CO2486B	375	Emu Heaven Indoor Cushion

Style Number Index *continued*

Style Number	Page	Description	Style Number	Page	Description
CO2486C	375	Emu Heaven Outdoor Cushion	CO2981	391	Emu Shade Cantilever Umbrella
CO2487	374	Emu Heaven Lounge Chair	CO2982	391	Emu Shade Center Post Umbrella
CO2487B	375	Emu Heaven Lounge Cushion	CO2984	391	Emu Shade Pentagonal Umbrella
CO2487C	375	Emu Heaven Lounge Cushion	CO300	294	Bindu Mid Back Executive Chair
CO2488B	376	Emu Heaven Lounge Pillow	CO300G	238, 295	Bindu Mid Back Guest/Side Chair
CO2488C	376	Emu Heaven Lounge Pillow	CO400	294	Bindu Mid Back High Back Executive Chair
CO2489B	376	Emu Heaven Lounge Back Cushion	COANDO	236	Andoo Chair
CO2489C	376	Emu Heaven Lounge Back Cushion	COANDOC LSD	236	Andoo Chair
CO2493	378	Emu Heaven Round Table	COANDOTBL67	237	Andoo Table
CO2493V	378	Emu Heaven Glass Top	COANDOTBL78	237	Andoo Table
CO2494	378	Emu Heaven Round Table	COCFS	344	Free Stand
CO2494V	378	Emu Heaven Glass Top	COCGM1836L	320	CG_1 Metal Low Rectangular Table
CO2495	376	Emu Heaven Pouf	COCGM1842L	320	CG_1 Metal Low Rectangular Table
CO2495B	376	Emu Heaven Indoor Cushion	COCGM2020H	321	CG_1 Metal High Square Table
CO2495C	376	Emu Heaven Outdoor Cushion	COCGM2424H	321	CG_1 Metal High Square Table
CO2495V	376	Emu Heaven Glass Top	COCGM2436H	321	CG_1 Metal High Rectangular Table
CO2496	378	Emu Heaven Side Table	COCGM3636L	320	CG_1 Metal Low Square Table
CO2497	377	Emu Heaven High Vase	COCGM4242L	320	CG_1 Metal Low Square Table
CO2498	377	Emu Heaven Low Vase	COCGM6060L	320	CG_1 Metal Low Square Table
CO2499	378	Emu Heaven Round Table Base	COCGW1836L	322	CG_1 Low Rectangular Table
CO2499V	378	Emu Heaven Glass Top	COCGW1842L	322	CG_1 Low Rectangular Table
CO2510	383	Emu Pattern Armless Chair	COCGW2020H	323	CG_1 High Square Table
CO2511	383	Emu Pattern Arm Chair	COCGW2424H	323	CG_1 High Square Table
CO2512	383	Emu Pattern 57"W Rectangular Bench	COCGW2436H	323	CG_1 High Rectangular Table
CO2518	384	Emu Pattern Small Round Table	COCGW3636L	322	CG_1 Low Square Table
CO2519	384	Emu Pattern Square Table	COCGW4242L	322	CG_1 Low Square Table
CO2520	384	Emu Pattern Large Round Table	CODAV	134	Davos Chair
CO2565MB	386	Emu Re-Trouvé Midback Chair	CODAV16	134	Davos Small Bench
CO2566B	387	Emu Re-Trouvé Indoor Cushion	CODAV38	134	Davos Medium Bench
CO2566C	387	Emu Re-Trouvé Outdoor Cushion	CODAV60	134	Davos Large Bench
CO2566HB	386	Emu Re-Trouvé Highback Chair	CODC145231	330	Denizen Console Table
CO2575	386	Emu Re-Trouvé Pouf	CODOLLY017	392	Emu Dolly
CO2575B	386	Emu Re-Trouvé Indoor Cushion	CODT163526	329	Denizen Tablet
CO2575C	386	Emu Re-Trouvé Outdoor Cushion	COEB2723H	352	Sebastopol 22" High Table
CO2577	387	Emu Re-Trouvé High Vase Frame	COEB2723L	352	Sebastopol 16" High Table
CO2578	387	Emu Re-Trouvé Low Vase Frame	COEB4118H	352	Sebastopol 22" High Table
CO2580	387	Emu Re-Trouvé Vase Insert	COEB4118L	352	Sebastopol 16" High Table
CO2581	380	Emu Ivy Side Chair	COEL100	256	Enea Lottus Armless Chair
CO2581B	381	Emu Ivy Side Chair Cushion	COEL100INSERT	256	Enea Lottus Armless Chair
CO2581C	381	Emu Ivy Side Chair Cushion	COEL100UPH	257	Enea Lottus Armless Chair
CO2582	380	Emu Ivy Side Arm Chair	COEL1830	339	Enea Lottus Occasional Table
CO2585	380	Emu Ivy Arm Chair	COEL1836	339	Enea Lottus Occasional Table
CO2585B	381	Emu Ivy Indoor Cushion	COEL1842	339	Enea Lottus Occasional Table
CO2585C	381	Emu Ivy Outdoor Cushion	COEL200	258	Enea Lottus Cantilever Arm Chair
CO2586	380	Emu Ivy Sofa	COEL200INSERT	258	Enea Lottus Cantilever Arm Chair
CO2586B	381	Emu Ivy Sofa Cushion	COEL200UPH	259	Enea Lottus Cantilever Arm Chair
CO2586C	381	Emu Ivy Sofa Cushion	COEL300	260	Enea Lottus Aluminum Loop Arm Chair
CO2589	382	Emu Ivy Rectangle Side Table	COEL300INSERT	260	Enea Lottus Aluminum Loop Arm Chair
CO2591	382	Emu Ivy Square Side Table	COEL300UPH	261	Enea Lottus Aluminum Loop Arm Chair
CO2592	382	Emu Ivy Rectangular Metal Top Table	COEL3030	340	Enea Lottus Conference Table
CO2593	382	Emu Ivy Rectangular Teak Top Table	COEL303072	343	Enea Lottus Rectangular Table
CO2595	381	Emu Ivy Pouf	COEL3036	340	Enea Lottus Conference Table
CO2596	382	Emu Ivy Square Table	COEL3042	340	Enea Lottus Conference Table
CO2597	382	Emu Ivy Square Table	COEL3624	341	Enea Lottus Café Counter Height Table
CO2980	391	Emu Shade Center Post Umbrella	COEL3630	341	Enea Lottus Café Counter Height Table

Style Number Index

Style Number	Page	Description	Style Number	Page	Description
COEL363072	343	Enea Lottus Rectangular Table	COMFL4	170	Millbrae Four-Seat Sofa
COEL3636	341	Enea Lottus Café Counter Height Table	COMFLA1	168	Millbrae Lounge
COEL3642	341	Enea Lottus Café Counter Height Table	COMFLA2	168	Millbrae Two-Seat Sofa
COEL400	263	Enea Lottus Sled Base Stool	COMFLA3	169	Millbrae Three-Seat Sofa
COEL400INSERT	263	Enea Lottus Sled Base Stool	COMFLA4	170	Millbrae Four-Seat Sofa
COEL400UPH	263	Enea Lottus Sled Base Stool	COMFLB1	171	Millbrae One-Seat Bench
COEL4224	342	Enea Lottus Café Bar Height Table	COMFLB2	171	Millbrae Two-Seat Bench
COEL4230	342	Enea Lottus Café Bar Height Table	COMFLB3	171	Millbrae Three-Seat Bench
COEL423072	343	Enea Lottus Rectangular Table	COMFLB4	171	Millbrae Four-Seat Bench
COEL4236	342	Enea Lottus Café Bar Height Table	COMFLLA1	168	Millbrae Lounge
COEL4242	342	Enea Lottus Café Bar Height Table	COMFLLA2	168	Millbrae Two-Seat Sofa
COEL500	262	Enea Lottus Sled Base Stool	COMFLLA3	169	Millbrae Three-Seat Sofa
COEL500INSERT	262	Enea Lottus Sled Base Stool	COMFLLA4	170	Millbrae Four-Seat Sofa
COEL500UPH	263	Enea Lottus Sled Base Stool	COMFLRA1	168	Millbrae Lounge
COEL600	265	Enea Lottus Post Base Stool	COMFLRA2	169	Millbrae Two-Seat Sofa
COEL600INSERT	265	Enea Lottus Post Base Stool	COMFLRA3	169	Millbrae Three-Seat Sofa
COEL600UPH	265	Enea Lottus Post Base Stool	COMFLRA4	170	Millbrae Four-Seat Sofa
COEL700	264	Enea Lottus Post Base Stool	COMLPRND	171	Millbrae Round Arm Bolster
COEL700INSERT	264	Enea Lottus Post Base Stool	COMLPSQR	171	Millbrae Square Arm Bolster
COEL700UPH	265	Enea Lottus Post Base Stool	COMOTL2020	172, 349	Millbrae Side Table
COELDOLLY	257	Enea Lottus Stacking Dolly	COMOTL2054	172, 349	Millbrae Rectangular Table
COHD	155	Holy Day Lounge Chair	COMOTL3030	172, 349	Millbrae Square Table
COHD30RCG	348	Holy Day Table	COMOTL3060	172, 349	Millbrae Rectangular Table
COHD30RCL	348	Holy Day Table	COMOTL3636	172, 349	Millbrae Square Table
COHD30RCW	348	Holy Day Table	COMOTL4848	172, 349	Millbrae Square Table
COHD35RDG	348	Holy Day Table	COMSL1	167	Millbrae Lounge
COHD35RDL	348	Holy Day Table	COMSL2	167	Millbrae Two-Seat
COHD35RDW	348	Holy Day Table	COMSL3	167	Millbrae Three-Seat
COHD35SQG	348	Holy Day Table	COPP01	353	Power Pod
COHD35SQL	348	Holy Day Table	COTO12369L15	217	Together Bench
COHD35SQW	348	Holy Day Table	COTO12369L8	217	Together Bench
COHDL	155	Holy Day Lounge Chair	COTO12369R15	219	Together Bench
COJHB100	232	Visalia Lounge	COTO12369R8	218	Together Bench
COJHB200	232	Visalia Lounge	COTO12396L15	217	Together Bench
COJHBC100	232	Visalia Lounge	COTO12396L8	217	Together Bench
COJHBC200	232	Visalia Lounge	COTO12396R15	219	Together Bench
COJHL100	231	Visalia Lounge	COTO12396R8	218	Together Bench
COJHL200	231	Visalia Lounge	COTO69	221	Together Bench
COJHL300	231	Visalia Lounge	COTO69WB15	220	Together Bench
COJHLC100	231	Visalia Lounge	COTO69WB8	220	Together Bench
COJHLC200	231	Visalia Lounge	COTO96	221	Together Bench
COJHLC300	231	Visalia Lounge	COTO9669L15	217	Together Bench
COLMS25	278	Last Minute Stool	COTO9669L8	216	Together Bench
COLMS30	278	Last Minute Stool	COTO9669R15	219	Together Bench
COLX100	279	Lox Chair	COTO9669R8	218	Together Bench
COLX110	279	Lox Chair	COTO9696L15	217	Together Bench
COLX200	280	Lox Stool	COTO9696L8	216	Together Bench
COLX210	280	Lox Stool	COTO9696R15	219	Together Bench
COMCLG	162	Massaud Lounge Chair	COTO9696R8	218	Together Bench
COMCOT	163	Massaud Ottoman	COTO96WB15	220	Together Bench
COMCWL	162	Massaud Work Lounge Chair	COTO96WB8	220	Together Bench
COMF1	171	Millbrae Ganging Kit	COURQL	157	Hosu Lounge w/Attached Lumbar
COMFL1	168	Millbrae Lounge	COURQLO	157	Hosu Lounge w/Ottoman and Attached Lumbar
COMFL2	168	Millbrae Lounge	COURQS	157	Hosu Two-Seat Sofar
COMFL3	169	Millbrae Three-Seat Sofa	COW110	193	SW_1 Lumbar Pillow

Style Number Index *continued*

Style Number	Page	Description	Style Number	Page	Description
COW210	193	SW_1 Ottoman	H35-T307236KW	337	Enea Table Twin Base
COW412	285	SW_1 Guest Chair	H35-T307236VL	337	Enea Table Twin Base
COW414	285	SW_1 Guest Chair	H35-T307236VW	337	Enea Table Twin Base
COW612	193	SW_1 Lowback Lounge Swivel Return Chair	H35-T307242GL	336	Enea Table Twin Base
COW712	193	SW_1 Highback Lounge Swivel Return Chair	H35-T307242GW	336	Enea Table Twin Base
COWK100	159	Joel Lounge	H35-T307242KL	337	Enea Table Twin Base
COWO_RND30	361	SW_1 Round Occasional Table	H35-T307242KW	337	Enea Table Twin Base
COWO_RND36	361	SW_1 Round Occasional Table	H35-T307242VL	337	Enea Table Twin Base
COWO_RND42	361	SW_1 Round Occasional Table	H35-T307242VW	337	Enea Table Twin Base
COWO_RND48	361	SW_1 Round Occasional Table	H35-T3618L	334	Enea Table Single Base
COWO_RND60	361	SW_1 Occasional Table	H35-T3618W	334	Enea Table Single Base
COWO_SQ30	361	SW_1 Square Occasional Table	H35-T3630L	334	Enea Table Single Base
COWO_SQ36	361	SW_1 Square Occasional Table	H35-T3630W	334	Enea Table Single Base
COWO_SQ42	361	SW_1 Square Occasional Table	H35-T3636L	335	Enea Table Single Base
COWO_SQ60	361	SW_1 Occasional Table	H35-T3636W	335	Enea Table Single Base
COWO_SSQ45	361	SW_1 Super-Square Occasional Table	H35-T3642L	335	Enea Table Single Base
COWRP4LEG	289	Wrapp Side Chair	H35-T3642W	335	Enea Table Single Base
COWRPSLD	289	Wrapp Side Chair	H35-T4218L	334	Enea Table Single Base
COWTABL	193	SW_1 Collaborative Lounge Seating	H35-T4218W	334	Enea Table Single Base
COWTABR	193	SW_1 Collaborative Lounge Seating	H35-T4230L	334	Enea Table Single Base
COWX_Q42	195	SW_1 Square Low Coll Conf Tbl	H35-T4230W	334	Enea Table Single Base
COWX_R4120	196	SW_1 Rectangular Low Coll Conf Tbl	H35-T4236L	335	Enea Table Single Base
COWX_R4284	196	SW_1 Rectangular Low Coll Conf Tbl	H35-T4236W	335	Enea Table Single Base
COWX_RND60	195	SW_1 Low Collaborative Conference Table	H35-T5430L	334	Enea Table Single Base
COWX_RND72	195	SW_1 Low Collaborative Conference Table	H35-T5430W	334	Enea Table Single Base
COWX_RND84	195	SW_1 Low Collaborative Conference Table	H35-T6030L	334	Enea Table Single Base
COWX_RND96	195	SW_1 Low Collaborative Conference Table	H35-T6030W	334	Enea Table Single Base
COWX_SE4072	196	SW_1 Super Elliptical Low Coll Conf Tbl	H350-S19	255	Enea Café Low Stool
COWX_SE4084	196	SW_1 Super Elliptical Low Coll Conf Tbl	H350-S27	255	Enea Café Counter-Height Stool
COWX_SE4096	196	SW_1 Super Elliptical Low Coll Conf Tbl	H350-S31	255	Enea Café Bar-Height Stool
COWX_SE4120	196	SW_1 Super Elliptical Low Coll Conf Tbl	H350-SB2719	253	Enea Cafe Stool with Back
COWX_SE4122	196	SW_1 Super Elliptical Low Coll Conf Tbl	H350-SB3119	253	Enea Cafe Stool with Back
COWX_SQ60	195	SW_1 Low Collaborative Conference Table	H351-SB2719	253	Enea Cafe Stool with Back
COWX_SQ72	195	SW_1 Low Collaborative Conference Table	H351-SB3119	253	Enea Cafe Stool with Back
COWX_SQ84	195	SW_1 Low Collaborative Conference Table	H352-S19	254	Enea Café Low Stool
COWX_SQ96	195	SW_1 Low Collaborative Conference Table	H352-S27	254	Enea Café Counter-Height Stool
H35-T2436L	335	Enea Table Single Base	H352-S31	255	Enea Café Bar-Height Stool
H35-T2436W	335	Enea Table Single Base	H352-SB2719	253	Enea Cafe Stool with Back
H35-T2442L	335	Enea Table Single Base	H352-SB3119	253	Enea Cafe Stool with Back
H35-T2442W	335	Enea Table Single Base	H353-S19	255	Enea Café Low Stool
H35-T3030L	334	Enea Table Single Base	H353-S27	255	Enea Café Counter-Height Stool
H35-T3030W	334	Enea Table Single Base	H353-S31	255	Enea Café Bar-Height Stool
H35-T3036L	335	Enea Table Single Base	H353-SB2719	253	Enea Cafe Stool with Back
H35-T3036W	335	Enea Table Single Base	H353-SB3119	253	Enea Cafe Stool with Back
H35-T3042L	335	Enea Table Single Base	PL2431	226	Topo Lounge
H35-T3042W	335	Enea Table Single Base	PLJ2417	226	Topo Lounge
H35-T307230GL	336	Enea Table Twin Base	PLM2431	227	Topo Mobile
H35-T307230GW	336	Enea Table Twin Base	PLMJ2417	227	Topo Mobile Jr.
H35-T307230KL	337	Enea Table Twin Base	TW19004	366	TeamWork Satellite Table
H35-T307230KW	337	Enea Table Twin Base	X1000	290	X-Stack Chair
H35-T307230VL	337	Enea Table Twin Base	X1000C	290	X-Stack Chair
H35-T307230VW	337	Enea Table Twin Base	X1010	291	X-Stack Chair
H35-T307236GL	336	Enea Table Twin Base	X1010C	291	X-Stack Chair
H35-T307236GW	336	Enea Table Twin Base	X1010CL	291	X-Stack Chair
H35-T307236KL	337	Enea Table Twin Base	X1010L	291	X-Stack Chair

Style Number Index

Style Number	Page	Description
X2200	290	X-Stack Chair
X2200C	290	X-Stack Chair
X2210	291	X-Stack Chair
X2210C	291	X-Stack Chair
X2210CL	291	X-Stack Chair
X2210L	291	X-Stack Chair

Trademark List

- ® The following are registered trademarks for products of Steelcase Inc. or one of its related corporate entities: 4 o'clock, 900 Series, à la carte, Airtouch, Ally, Amia, Answer, Archipelago, Avenir, Ballet, Bix, Brayton International, Cachet, Canopy, Canto, Chancellor, Coalesse, Confidante, Context, Convene, CopyCam, Criterion, Crushed Can, Currency, dash, Designtex, Details, Detour, Drive, Elective Elements, Ellipse, Ember Chrome, Emerge, E-Table 2, FYI, Garland, Gentry, Ginkgo Biloba, Groupwork, Ideo, Jacket, Jenny, Jersey, Kart, Kick, LaCosta, Leap, Let's B, LiveBack, Max-Stacker, media:scape, Metro, Migrations, Mitra, Montage, Nurture, Oriana, Parade, Pathways, PCT, Permiso, Player, PolyVision, Portal, Power Pincher, Progeny, Protégé, R2, Rally, Relevant, Reply, Rizzi Arc, Sensor, Series 9000, Siento, Sieste, Sine, Softcare, Springboard, Steelcase, Steelcase Design Partnership, Stella, Stow Davis, Swathmore, TeamWork, Technique, Texpress, Think, Thunder, Topo, Train, Turnstone, Underline, Unison, Vecta, Viridian, Walden, Werndl, and X-Stack.
- ® The following registered trademarks are under license from AWI Licensing Company, Dover, DE: SoundScapes, DuraBrite, BioBlock, and Armstrong.
- ® The following registered trademarks are under license from Byrne Electrical, Rockford, MI: Interport and Mini-Port.
- ® The following is a registered trademark of DuPont, Wilmington, DE: Corian.
- ® The following is a registered trademark of Genlyte Thomas Company, Louisville, KY: Lightolier.
- ® The following is a registered trademark of Hilti Corporation, FL-9494 Schaan, Principality of Liechtenstein: Hilti.
- ® The following is a registered trademark of Leviton Manufacturing Company, Little Neck, NY: Decora.
- ® The following is a registered trademark of Mechanical Plastics Corp, Elmsford, NY: Toggler.
- ® The following is a registered trademark of Microsoft Corporation, Redmond, WA: Microsoft.
- ® The following is a registered trademark of Panduit Corporation, Lockport, IL: Panduit.
- ® The following is a registered trademark of Trav (Press), Cuneo, Italy: Assisa.
- ® The following is a registered trademark of Virtual Ink, Boston, MA: mimioActive.
- ® The following registered trademarks are under license from Wilkhahn Furniture Products: Avera, Senzo, Versal, and Wilkhahn FS.
- ® The following is a registered trademark of Wilsonart International, Temple, TX: Chemsurf.

- ® The following is a registered trademark of Wiremold, West Hartford, CT: Wiremold.
- ® The following is a registered trademark of EMU Group S.P.A., Perugia, Italy: Emu
- ™ The following are trademarks for products of Steelcase Inc. or one of its related corporate entities: Access, Active/Passive Shelf, Ainsley, Akira, Alcove, Alerion, aLight, Amaris, American Elect, American Tradition, ap40, Arbor, Arriva, Asana, Ascot, Aspekt, Astor, Await, Bira, Bivi, Bottomline, Brook, Buoy, Burton, c:scape, Calla, Calm, Camber, Campfire, Capa, Cappuccino, Cesar, Chester, Chord, Circa, Clarendon, Classic Rectangular, cobi, Collaboration, Community, Company, Convey, Cortex, Coupe, Crea, Crew, Cura, Cypress, Davenport, Dearborn, Deck, Déjà, Denizen, Denska, Derby, Divisio, Donovan, Dune, Duo, e³, e³ ceramicsteel, e³ environmental ceramicsteel, Echo, Edge, Elsna, Empath, Empress, Enea, ēno, EnSync, Enviro, Escapade, Exchange, Exponents, Field, Flat Top, FlexFrame, Flip Top, Flute, Folio, FrameOne, FreeFlow, Frontier, Galilei, Gesture, Ginger, Ginkgo, Go Wall, Grip, Groove, Hatchback, Hawthorne, Hitch, Host Collection, Hosu, Huddleboard, i2i, Impact, Indy, InfoLink, IOS, I-Solve, Jack, Jarrah, Jetty, Juice, Kami, Kast, Kathryn, Lark, L'Attitude, LearnLab, Leela, Lincoln, Linden, LiveSeat, Loria, Lyric, Malibu, Malibu Too, Mansfield, Marathon, Martini, Mason, Masque, Millbrae, Mineral, Mingle, Mystic, Mystic Metal, Mystic Wood, Montreal, Move, Nadia, Neighbor, nesso, Nickel, Nikko, Nod, Node, Norfolk, Ontrak, Oom, Opus, Orchid, Outlook Collection, Ovation, Paloma, Paperflo, Parliament, Pasio, Passerelle, Patriarch, Payback, Peek, Pile File, Pisa, Pool, PUCK, QiVi, Quba, Rave, Reed, Regard, Relay, Reunion, Ripple, Riser, Rocco, Rocky, RoomWizard, Runner, Satellite, Sawyer, ScapeSeries, Senti, Sentinel, Senza, Sequoia, Session, ShareLink, Shield, Sidewalk, Skylar, Slumber, Smoke, Snug, Soft Leaf, Sonata, Sorrel, SOTO, Stationkits, Stiletto, Surprise!, Switch, Symphony, Sync, TagWizard, Tava, TeamStudio, Tenaro, Terrazzo, Theorem, Topaz, Touchdown, Tour, Tower Too, Trees, Trillium, Trolly, tX2, U-Free, Uno, V.I.A., Verb, Verge, Victor2, Visalia, Waldorf, Woodruff, Workspring, and X-tenz.
- ™ The following is a trademark of Microsoft Corporation, Redmond, WA: Windows.
- ™ The following is a trademark of Rodman Industries, Inc., Oconomowoc, WI: ResinCore1.
- ™ The following is a trademark of Ultrafabrics, LLC, Elmsford, NY: Ultraleather.
- ™ The following trademarks are under license from Wilkhahn Furniture products: Cana, Linus, Logon, Picto, Range, Stitz, Thema, Timetable, and Tubis.
- ™ The following is a trademark of MBDC, Charlottesville, VA: Cradle to Cradle and C2C.
- ™ The following trademarks are under license

from Walter Knoll: Andoo, Bob, Lazlo, Lox, Ribbon, and Together

™ The following trademarks are under license from PP Möbler: Bar and Flag Halyard.

™ The following trademarks are under license from Viccarbe: Davos, Holy Day, Last Minute, RS, and Wrapp.

™ The following trademarks are under license from Carl Hansen: Elbow, Paddle, Shell, Wing, and Wishbone.

™ The following trademarks are under license from Cambridge Sound Management, LLC, Cambridge, MA: Qt PRO Soundmasking, Qt Quiet Technology, and Sonet Qt.

™ The following is a trademark of Electri-Cable Assemblies, Shelton, CT: Interact.

Trademarks used here in are the property of Steelcase, Inc. or of their respective owners.