



# Quick Ship Guide

December 15, 2014

*Featuring Steelcase, Turnstone 1.0 Seating, Details, and Coalesse products.*

## Contents

<b>Statement of Line at a Glance</b>	<b>2</b>
 <b>Rapid2</b> Ships in 2 days.	<b>9</b>
 <b>Rapid5</b> Ships in 5-7 days.	<b>19</b>
 <b>Rapid10</b> Coalesse Ships in 10 days.	<b>47</b>

► For a list of all trademarks, refer to the last page.

# Statement of Line at a Glance

Tip: See individual product pages for information on models offered.

## Systems

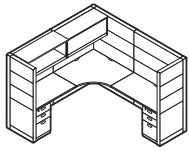

**Answer Solutions**

▶ Page 21

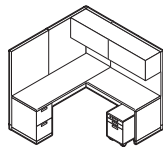

**Avenir**

▶ Page 21

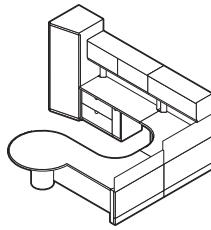

**Context**

▶ Page 22

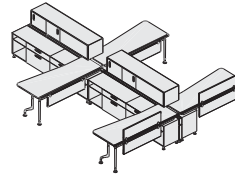

**c:scape**

▶ Page 22

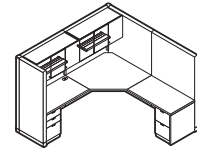

**Elective Elements**

▶ Page 34

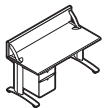

**Ellipse**

▶ Page 23

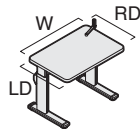

**Details Height-Adjustable Worksurfaces**

▶ Page 40

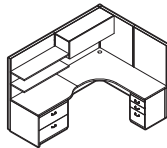

**Kick**

▶ Page 23

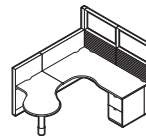

**Montage Solutions**

▶ Page 24

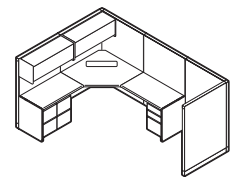

**Series 9000**

▶ Page 24

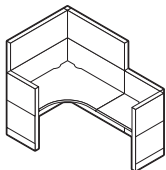

**Universal Worksurface Products**

▶ Page 25

## Wood Caseworks

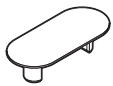

**Convene**

▶ Page 34

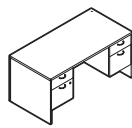

**Currency**

▶ Page 34

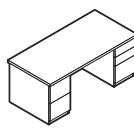

**Garland**

▶ Page 34

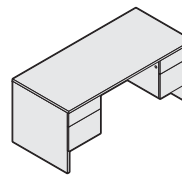

**Payback**

▶ Page 35

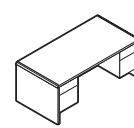

**Walden**

▶ Page 36

**Tables**

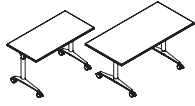

**Akira Tables**

▶ Page 56



**Await Tables**

▶ Page 55

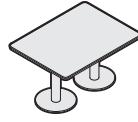

**Bix Tables**

▶ Page 55

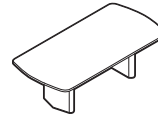

**E-Tables2**

▶ Page 56

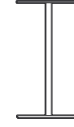

**Enea Tables**

▶ Page 55



**Runner Tables**

▶ Page 57

**Storage**

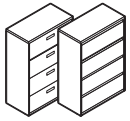

**800 and 900 Series  
Lateral Files and  
Cabinets**

▶ Page 26



**TS 200 Series  
Storage**

▶ Page 15

▶ Page 26



**Overfile Cabinets**

▶ Page 26

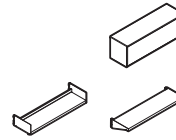

**Universal Overhead  
Storage**

▶ Page 26

**Storage Tops and  
Shelves**

▶ Page 26

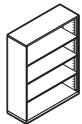

**Universal Bookcases**

▶ Page 26

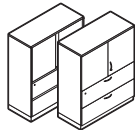

**Universal Combination  
Cabinets**

▶ Page 26



**Universal Full Front  
Towers**

▶ Page 26

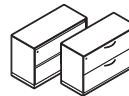

**Universal Lateral Files**

▶ Page 26

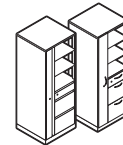

**Universal Open Side  
Towers**

▶ Page 26

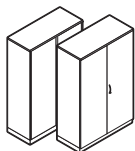

**Universal Storage  
Cabinets**

▶ Page 26



**Universal Storage  
Pedestals**

▶ Page 26



**Universal Vertical  
Drawer Towers**

▶ Page 26

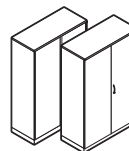

**Universal Wardrobe  
Cabinets**

▶ Page 26



**Universal Workstation  
Verticals**

▶ Page 26

### Meeting Spaces

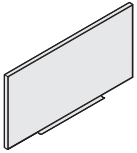

**Premium Whiteboards**

5 ▶ Page 27

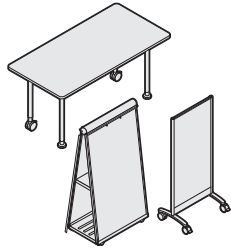

**Groupwork**

5 ▶ Page 27



**Verb**

5 ▶ Page 27

### Collaborative Seating



**Node 480 Series**

5 ▶ Page 30



**cobi 434 Series**

5 ▶ Page 28

### Desk Seating



**á la carte**

5 ▶ Page 32



**Amia**

2 5 ▶ Page 11

5 ▶ Page 28



**Cachet 487 Series**

2 5 ▶ Page 11

5 ▶ Page 28



**Crew**

2 5 ▶ Page 14

5 ▶ Page 32



**Criterion 453 Series**

5 ▶ Page 28



**Gesture 442 Series**

5 ▶ Page 29



**Jacket**

5 ▶ Page 33



**Jersey**

5 ▶ Page 29



**Kart**

10 5 ▶ Page 53



**Leap 462 Series**

2 5 ▶ Page 12

5 ▶ Page 29

**Desk Seating, continued**



**Protégé 433 Series**

5 ▶ Page 30



**Reply Series**

2 ▶ Page 13

5 ▶ Page 31



**Think 465 Series**

2 ▶ Page 13

5 ▶ Page 31



**Uno**

2 ▶ Page 14

5 ▶ Page 33

**Guest Seating**



**Alcove**

5 ▶ Page 37



**Collaboration**

5 ▶ Page 37



**Deck**

5 ▶ Page 37



**Enea Barstool**

10 ▶ Page 52



**Enea Stool**

10 ▶ Page 52



**England**

5 ▶ Page 37



**Escapade**

5 ▶ Page 38



**Kart Stool**

10 ▶ Page 53



**Mingle**

5 ▶ Page 38



**Move 490 Series**

2 ▶ Page 12

5 ▶ Page 29



**Oriana**

5 ▶ Page 38

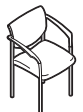

**Player 475 Series**

5 ▶ Page 30



**Protégé 433 Series**

5 ▶ Page 30



**Reply 466 Series**

5 ▶ Page 31



**Sawyer**

5 ▶ Page 38



**Snodgrass**

5 ▶ Page 39



**Terrazzo**

5 ▶ Page 38



**Topaz**

5 ▶ Page 38

**Lounge Seating**



**Astor**

10 ▶ Page 51

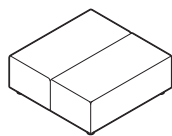

**Await Lounge**

10 ▶ Page 51

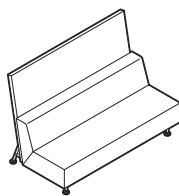

**Bix Lounge**

10 ▶ Page 51

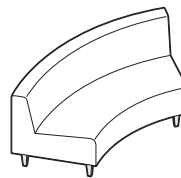

**Circa Lounge**

10 ▶ Page 51

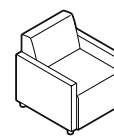

**Coupe Lounge**

10 ▶ Page 52



**Swathmore Lounge**

10 ▶ Page 53



**Swathmore Mobile**

10 ▶ Page 53

**Stackable Seating**



**Domino**

2 ▶ Page 14

5 ▶ Page 33



**Enea Stacker**

10 ▶ Page 52



**Kart Stack**

10 ▶ Page 53



**Max-Stacker 472 Series**

5 ▶ Page 29



**Max-Stacker II  
473 Series**

5 ▶ Page 29



**X-Stack**

10 ▶ Page 54

**Indoor/Outdoor**



**Emu Round Chair**

10 ▶ Page 54

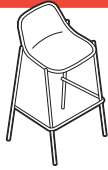

**Emu Round Stools**

10 ▶ Page 54



**Emu Round Square Table**

10 ▶ Page 54



**Emu Heaven Chair**

10 ▶ Page 54



**Emu Heaven Arm Chair**

10 ▶ Page 54

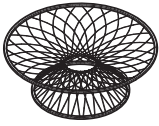

**Emu Heaven Table**

10 ▶ Page 54



**Emu Heaven Glass Top**

10 ▶ Page 54

**Accessories**



**Shelf Lights**

5 ▶ Page 27

**Indoor/Outdoor**

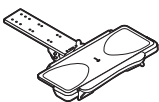

**Details Computer Support Tools**

2 ▶ Page 16

5 ▶ Page 40



**Details Organizational Worktools**

2 ▶ Page 16

5 ▶ Page 40



**Details Task Lighting**

2 ▶ Page 16

5 ▶ Page 40

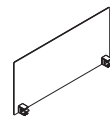

**Privacy**

5 ▶ Page 40





# Rapid2

Effective December 15, 2014

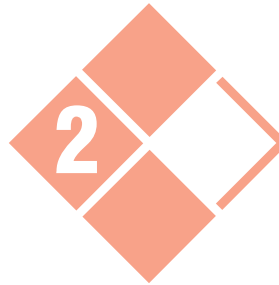

*Featuring Steelcase, Turnstone 1.0 Seating, and Details products shipping in two business days.*

- U.S. electronic price list support:  
December 15, 2014 (180.E)

## Contents

Program Overview	10
How to Order	10
Discounts and Pricing	10
Rapid2 Planner	10

## Product Offering

Steelcase Seating	11
Turnstone 1.0 Seating	14
Steelcase Storage	15
Details	16
Rapid2 Surface Materials	17

### Questions?

Call Steelcase at 1.888.STEELCASE or send an email to [lineone@steelcase.com](mailto:lineone@steelcase.com) (Outside the U.S.A., Canada, Mexico, Puerto Rico, and the U.S. Virgin Islands, call 616.247.2500).

# Rapid2

Steelcase, Turnstone 1.0, & Details

## Program Overview

The Rapid2 program provides our best selling seating, storage products, and ergonomic worktools with expedited manufacturing. All products are made-to-order and shipped within two business days.

### Products Included in Rapid2:

#### Steelcase Seating

- Amia 482 Series
- Cachet 487 Series
- Leap 462 Series
- Move 490 Series
- Reply 466 Series
- Think 465 Series

*Over 80 upholstery choices available*

#### Steelcase Storage

- TS 200 Series Laterals
- 15 paint choices available*

#### Turnstone 1.0 Seating

- Crew (TS308)
- Domino (TS371)
- Uno (TS311)

#### Details

- Computer Support Tools
- Organizational Worktools
- Lighting

▶ See *Rapid2 Surface Materials*, page 17

## How to Order

- Orders must be specified and transmitted using the SQ1 electronic catalog to ensure orders are processed quickly. -Use electronic catalog code: SQ1 Steelcase Rapid2
- Orders cannot be changed or cancelled.
- There are no quantity restrictions. However, once in awhile, demand exceeds capacity. When this occurs, orders will automatically be moved to the next available manufacturing schedule.
- The Rapid2 program is limited to the models, fabrics, and finishes listed in the electronic catalogs listed above.
- Consult the specification guide for product details.

## Discounts and Pricing

- Steelcase Seating 50/12
- Steelcase Storage 50/17
- Turnstone 1.0 Seating 50/20
- Details 50/10

## Rapid2 Planner

### Manufacturing Time

Rapid2 orders are manufactured and shipped within two business days.

Example:

Monday	Tuesday	Wednesday	Thursday	Friday	Sat/Sun
		<b>Day 0</b> Steelcase receives complete and clean order before 5:00pm EST	<b>Day 1</b> Order is manufactured	<b>Day 2</b> Order is shipped from manufacturing facility	

*2-business days does not include weekends, national holidays, or Steelcase holidays. Orders will ship through the Steelcase distribution network.*



### Estimated Delivery Time

#### (from Grand Rapids, MI to Ship-to Site)

After your order ships, delivery transit time will take 2-7 business days depending on your destination. Refer to the map below for delivery days to specific locations. Use this information to calculate estimated arrival.

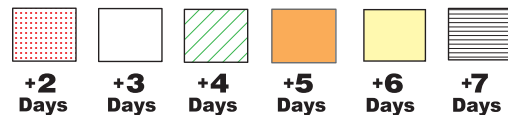
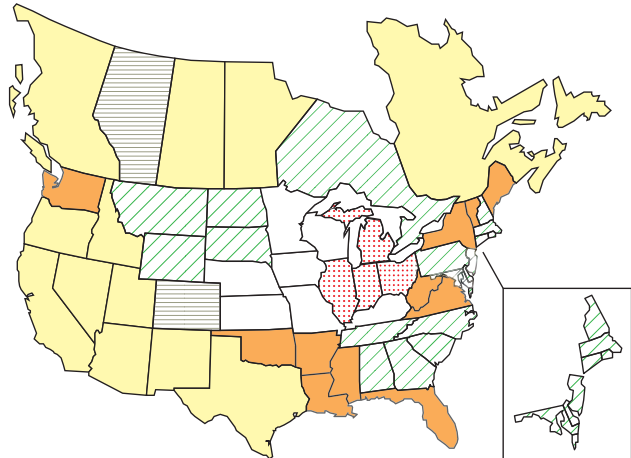

Example: Delivery time for dealer located in Pennsylvania

- Day 0 - Steelcase receives order
- Day 1 - Order is manufactured
- Day 2 - Order ships from manufacturing facility
- Day 3 - 5 - In transit
- Day 6 - Order arrives to dealer

*Dealer profiles and warehouse scheduled delivery days will impact delivery day. Contact the Steelcase Solutions Fulfillment Team representative for expedited delivery options. Additional charges may apply.*

## Amia 482 Series



- Synchro-tilt mechanism
- 5" and 7" pneumatic seat-height adjustment
- Upright back lock
- Rectilinear independent height-, width-, pivot-, and depth-adjustable arms and soft arm caps: black plastic
- Frame, seat shell, outer back, and five-arm base: plastic
- 3" seat depth adjustment
- Passive seat edge angle
- Adjustable lumbar
- 2½" diameter, hard-composition, dual-wheel casters: black

### Available Products

Style Number	Description
4821410	Upholstered seat and back
4821410S	Sewn upholstery, black leather, or Stand In only

The following Amia option is available:

- Soft casters

### Surface Materials

#### Seating Upholstery

Brisa - Price Group 6 - BR01 Black Onyx, BR04 Truffle, BR07 Sage, BR10 Night Navy, BR18 New Sand

Buzz2 - Price Group 1 - all colors are available

Cogent: Connect - Price Group 2 - all colors are available

Crosswalk - Price Group 2 - all colors are available

Link - Price Group 1 - all colors are available

Nitelights - Price Group 2 - all colors are available

Stand In - Price Group 2 - all colors are available

► See *Rapid2 Surface Materials*, page 17

#### Leather (Sewn models only)

L107 Black Leather

#### Seating Plastic

6205 Black

6249 Platinum Solid

## Cachet 487 Series



- Balanced-action rocker (BAR) mechanism
- Frame, seat, back, flip-up arms on swivel, and five-arm base on swivel, four-leg base on four-leg: plastic
- 5" pneumatic seat-height adjustment on swivel
- 2¾" diameter, hard composition, dual-wheel casters: black plastic on swivel
- Hard glides on four-leg

### Available Products

Style Number	Description
4871110	Swivel base work chair, with arms, non-upholstered (soft casters standard)

The following Cachet options are available:

- Soft casters
- Soft glides

### Surface Materials

#### Seating Plastic

6205 Black

## Leap 462 Series



- Upper back force
- 5" and 7" pneumatic seat-height adjustment
- Variable back stop
- Lower back firmness
- Rectilinear independent height-, width-, pivot-, and depth-adjustable arms and soft arm caps, if selected: black plastic
- Frame, seat shell, outer back, and five-arm base: plastic
- 3" seat depth adjustment
- Passive seat edge angle
- Adjustable lumbar
- 2½" diameter, hard-composition, dual-wheel casters: black

### Available Products

Style Number	Description
<b>46216179</b>	Upholstered seat and back
<b>46216179S</b>	Sewn upholstery, black leather, or Stand In only
<b>LEAPV2</b>	Buzz2 upholstery and black plastic

The following Leap option is available:

- Soft casters

### Surface Materials

#### Seating Upholstery

- Brisa - Price Group 6 - BR01 Black Onyx, BR04 Truffle, BR07 Sage, BR10 Night Navy, BR18 New Sand
- Buzz2 - Price Group 1 - all colors are available
- Cogent: Connect - Price Group 2 - all colors are available
- Crosswalk - Price Group 2 - all colors are available
- Link - Price Group 1 - all colors are available
- Nitelights - Price Group 2 - all colors are available
- Stand In - Price Group 2 - all colors are available

▶ See *Rapid2 Surface Materials*, page 17

#### Leather (Sewn models only)

- L107 Black Leather

#### Seating Plastic

- 6205 Black
- 6249 Platinum Solid

## Move 490 Series



- Frame: paint
- Back shell: plastic
- Seat: fabric
- Arms, if selected: plastic to match back shell
- Glides, if selected: plastic with stainless steel inserts
- Hard, dual-wheel casters, if selected: black
- Hard glides, if selected

### Available Products

Style Number	Description
<b>490410</b>	Plastic back without arms, upholstered seat, with glides
<b>490410C</b>	Plastic back without arms, upholstered seat, with hard dual casters
<b>490412</b>	Plastic back with arms, upholstered seat, with glides
<b>490412C</b>	Plastic back with arms, upholstered seat, with hard dual casters

The following Move options are available:

- Soft casters
- Soft glides

### Surface Materials

#### Seating Upholstery

- Brisa - Price Group 6 - BR01 Black Onyx, BR04 Truffle, BR07 Sage, BR10 Night Navy, BR18 New Sand
- Buzz2 - Price Group 1 - all colors are available
- Cogent: Connect - Price Group 2 - all colors are available
- Crosswalk - Price Group 2 - all colors are available
- Link - Price Group 1 - all colors are available
- Nitelights - Price Group 2 - all colors are available
- Stand In - Price Group 2 - all colors are available
- ▶ See *Rapid2 Surface Materials*, page 17

#### Leather

- L107 Black Leather

#### Seating Plastic

- 6205 Black
- 6249 Platinum Solid

#### Paint

- 0835 Black
- 4799 Platinum

## Reply 466 Series



- Synchro-tilt mechanism
- 5" pneumatic seat-height adjustment (16" – 21")
- Multi-position back lock
- Outer back, seat shell, and five-arm plastic base: plastic
- 1½" Seat depth adjustment
- 2½" diameter, hard-composition, dual-wheel casters, black

### Available Products

Style Number	Description
<b>466160MP</b>	Task chair, with standard upholstery on seat and back
<b>466160MT</b>	Task chair, mesh back with standard upholstery on seat
<b>466450MH</b>	Leg-base multi-use chair, standard upholstery on seat and back, without arms
<b>466450MT</b>	Leg-base multi-use chair, mesh back with standard upholstery on seat, without arms
<b>466452MH</b>	Leg-base multi-use chair, standard upholstery on seat and back, with arms
<b>466452MT</b>	Leg-base multi-use chair, mesh back with standard upholstery on seat, with arms
<b>466480MH</b>	Sled-base multi-use chair, standard upholstery on seat and back, without arms
<b>466480MT</b>	Sled-base multi-use chair, mesh back with standard upholstery on seat, without arms
<b>466482MH</b>	Sled-base multi-use chair, standard upholstery on seat and back, with arms
<b>466482MT</b>	Sled-base multi-use chair, mesh back with standard upholstery on seat, with arms

The following Reply options are available:

- Lumbar height
- Soft casters and glides
- Height-adjustable arms, soft arm caps

### Surface Materials

#### Reply Mesh

AR02 Black

#### Seating Upholstery

Buzz2 – Price Group 1 - all colors are available  
 Cogent: Connect - Price Group 2 - all colors are available  
 Crosswalk – Price Group 2 - all colors are available  
 Link – Price Group 1 - all colors are available  
 Nitelights - Price Group 2 - all colors are available  
 Stand In - Price Group 2 - all colors are available

▶ See *Rapid2 Surface Materials*, page 17

#### Seating Plastic

6205 Black  
 6249 Platinum

## Think 465 Series



- 5" pneumatic seat-height adjustment (16"–21")
- Your Preference control
- Passive seat edge angle
- Frame, seat shell, and five-arm plastic base
- 2" seat depth adjustment
- Height-, width-, pivot-, and depth-adjustable arms
- 2½" diameter, hard-composition, dual-wheel casters: black

### Available Products

Style Number	Description
<b>46543100</b>	3D Knit on back and upholstered seat
<b>46540100</b>	Upholstered seat and back

The following Think options are available:

- Lumbar height
- Soft casters
- Fixed arm

### Surface Materials

#### 3D Knit

5064	Black
5065	Coconut
5066	Malt
5067	Root Beer
5068	Charcoal

#### Seating Upholstery

Brisa - Price Group 6 - BR01 Black Onyx, BR04 Truffle, BR07 Sage, BR10 Night Navy, BR18 New Sand  
 Buzz2 - Price Group 1 - all colors are available  
 Crosswalk - Price Group 2 - all colors are available  
 Link - Price Group 1 - all colors are available  
 Nitelights - Price Group 2 - all colors are available  
 Stand In - Price Group 2 - all colors are available

▶ See *Rapid2 Surface Materials*, page 17

#### Leather (Sewn models only)

L107 Black

#### Seating Plastic

6205	Black
6249	Platinum Solid

# Turnstone 1.0 Seating, Rapid2

## Crew



- Full-back task chair
- Synchro-tilt mechanism
- Pneumatic height adjustment
- Upright back lock
- Tilt tension
- Back height adjustment
- Upholstered seat and inner back
- Black frame

### Available Products

Style Number	Description
<b>TS30801</b>	Armless
<b>TS30811</b>	With fixed-height T-arms
<b>TS30821</b>	With height- and width-adjustable T-arms
<b>TS30802</b>	With adjustable seat depth, armless
<b>TS30812</b>	With adjustable seat depth, with fixed-height T-arms
<b>TS30822</b>	With adjustable seat depth, with height- and width-adjustable T-arms
<b>TS30831</b>	With height-, width-, and pivot-adjustable arms
<b>TS30832</b>	With adjustable seat depth, with height-, width-, and pivot-adjustable arms
<b>TS30833</b>	With height-, width-, and pivot-adjustable arms, and stool kit

The following Crew options are available:

- Soft dual-wheel casters for use on hard floors
- Stool kit

### Surface Materials

#### Seating Upholstery

- Brisa - Price Group 6 - BR01 Black Onyx, BR04 Truffle, BR07 Sage, BR10 Night Navy, BR18 New Sand
- Buzz2 - Price Group 1 - all colors are available
- Cogent: Connect - Price Group 2 - all colors are available
- Crosswalk - Price Group 2 - all colors are available
- Link - Price Group 1 - all colors are available
- Nitelights - Price Group 2 - all colors are available
- Stand In - Price Group 2 - all colors are available

▶ See *Rapid2 Surface Materials*, page 17

## Domino



- Frame: black
- Shell: 6205 black plastic
- Glides that gang
- Package of four

### Available Products

Style Number	Description
<b>TS37101</b>	Stack chair, package of four

## Uno



- Hammock-style support
- Pneumatic height adjustment
- Swivel mechanism
- Mid-back or high-back
- Upholstered seat and back
- Outer back: black plastic
- Hard dual-wheel casters

### Available Products

Style Number	Description
<b>TS31101</b>	Multi-purpose chair, mid-back
<b>TS31102</b>	Multi-purpose chair, high-back

The following Uno options are available:

- Soft dual-wheel casters for use on hard floors
- Non-marring plastic glides
- Stool kit

### Surface Materials

#### Seating Upholstery

- Brisa - Price Group 6 - BR01 Black Onyx, BR04 Truffle, BR07 Sage, BR10 Night Navy, BR18 New Sand
- Buzz2 - Price Group 1 - all colors are available
- Cogent: Connect - Price Group 2 - all colors are available
- Crosswalk - Price Group 2 - all colors are available
- Link - Price Group 1 - all colors are available
- Nitelights - Price Group 2 - all colors are available
- Stand In - Price Group 2 - all colors are available

▶ See *Rapid2 Surface Materials*, page 17

## TS 200 Series Lateral Files

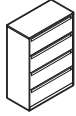

- Flush-front lateral file with full-width pull: paint price group 1
- 1"H top: paint to match file
- Lift-up door with fixed shelf, if selected: paint to match file
- Lock, keyed random: 9201 polished chrome
- One label holder per drawer: clear plastic
- Drawer body: black only
- Drawer suspensions: black only
- One hanging folder bar per drawer
- Four adjustable leveling glides
- Counterweight package, if selected

### Available Products

Style Number	Description
<b>2LF18302F</b>	Two 12"H Drawers, 30"W
<b>2LF18362F</b>	Two 12"H Drawers, 36"W
<b>2LF18422F</b>	Two 12"H Drawers, 42"W
<b>2LF18303F</b>	Three 12"H Drawers, 30"W
<b>2LF18363F</b>	Three 12"H Drawers, 36"W
<b>2LF18423F</b>	Three 12"H Drawers, 42"W
<b>2LF18304F</b>	Four 12"H Drawers, 30"W
<b>2LF18364F</b>	Four 12"H Drawers, 36"W
<b>2LF18424F</b>	Four 12"H Drawers, 42"W
<b>2LF18305F</b>	Four 12"H Drawers and One 13½"H Lift-Up Door with Fixed Shelf, 30"W
<b>2LF18365F</b>	Four 12"H Drawers and One 13½"H Lift-Up Door with Fixed Shelf, 36"W
<b>2LF18425F</b>	Four 12"H Drawers and One 13½"H Lift-Up Door with Fixed Shelf, 42"W

The following options are available on TS 200 Series Lateral Files:

- No top
- Security top
- Lift-up door on 65½"H files
- Rails and divider package
- Counterweights
- Ember chrome lock 9250
- Factory- and field-installed keying

### Surface Materials

Smooth Paint	Smooth Metallic Paint
4242 Milk	4743 Mineral Metallic
	4744 Pearl Metallic
	4750 Champagne Metallic
<b>Textured Paint</b>	4798 Sterling Metallic
7207 Black	4799 Platinum Metallic
7225 Sand	4803 Near Black Metallic
7230 Basalt	
7238 Fieldstone	
7239 Midnight	
7241 Arctic White	
7243 Seagull	
<b>Textured Metallic Paint</b>	
7245 Carbon Metallic	
7246 Midnight Metallic	

## TS 200 Series Lateral Files with Lift-up Doors and Roll-Out Shelves

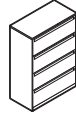

- Flush-front lateral file with full-width pull: paint price group 1
- 1"H top: paint to match file
- Lift-up doors with roll-out shelves: paint to match file
- Lock, keyed random: 9201 polished chrome
- One label holder per door: clear plastic
- One divider package per roll-out shelf
- Four adjustable leveling glides
- Counterweight package, if selected

### Available Products

Style Number	Description
<b>2LF18302AF</b>	Two 12"H Lift-Up Doors with Roll-Out Shelves With Lock, 30"W
<b>2LF18362AF</b>	Two 12"H Lift-Up Doors with Roll-Out Shelves With Lock, 36"W
<b>2LF18422AF</b>	Two 12"H Lift-Up Doors with Roll-Out Shelves With Lock, 42"W
<b>2LF18303AF</b>	Three 12"H Lift-Up Doors with Roll-Out Shelves With Lock, 30"W
<b>2LF18363AF</b>	Three 12"H Lift-Up Doors with Roll-Out Shelves With Lock, 36"W
<b>2LF18423AF</b>	Three 12"H Lift-Up Doors with Roll-Out Shelves With Lock, 42"W
<b>2LF18304AF</b>	Four 12"H Lift-Up Doors with Roll-Out Shelves With Lock, 30"W
<b>2LF18364AF</b>	Four 12"H Lift-Up Doors with Roll-Out Shelves With Lock, 36"W
<b>2LF18424AF</b>	Four 12"H Lift-Up Doors with Roll-Out Shelves With Lock, 42"W
<b>2LF18305AF</b>	One 13½"H Lift-Up Door with Roll-Out Shelf and Four 12"H Lift-Up Doors with Roll-Out Shelves With Lock, 30"W
<b>2LF18365AF</b>	One 13½"H Lift-Up Door with Roll-Out Shelf and Four 12"H Lift-Up Doors with Roll-Out Shelves With Lock, 36"W
<b>2LF18425AF</b>	One 13½"H Lift-Up Door with Roll-Out Shelf and Four 12"H Lift-Up Doors with Roll-Out Shelves With Lock, 42"W

The following options are available on TS 200 Series Lateral Files with Lift-Up Doors and Roll-Out Shelves:

- Hanging folder bars
- Counterweights
- Ember chrome lock 9250
- Factory- and field-installed keying

### Surface Materials

Smooth Paint	Textured Metallic Paint
4242 Milk	7245 Carbon Metallic
	7246 Midnight Metallic
<b>Textured Paint</b>	<b>Smooth Metallic Paint</b>
7207 Black	4743 Mineral Metallic
7225 Sand	4744 Pearl Metallic
7230 Basalt	4750 Champagne Metallic
7238 Fieldstone	4798 Sterling Metallic
7239 Midnight	4799 Platinum Metallic
7241 Arctic White	4803 Near Black Metallic
7243 Seagull	



# Details, Rapid2

## Computer Support Tools

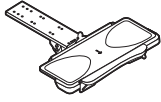

- Ergonomic solutions that help people interact with computers
- Minimize physical trauma, increase safety and comfort
- Support technology in user workspaces

### Available Products

Style Number	Description
<b>Processing Worktools</b>	
<b>CPRCCN</b>	Vertical non-locking CPU cradle
<b>CPRSL</b>	Vertical processor sling
<b>Platforms Only</b>	
<b>18" Radius Platform</b>	
<b>1810EF</b>	18" Radius platform with extended foam palm rest
<b>19" Platform</b>	
<b>19AMGG</b>	19" Platform, articulated mousing surface with green-gel palm rest
<b>19MRGG</b>	19" Platform, right mousing surface with green-gel palm rest
<b>Slider Platform</b>	
<b>SL10SA</b>	Slider platform with standard adjustable palm rest
<b>Jules</b>	
<b>JP10SF</b>	Jules platform with standard foam palm rest in Charcoal finish
<b>SS20JP10SF</b>	Stella standard with Jules platform with standard foam palm rest in Charcoal finish
<b>Lift and Lock</b>	
<b>L5231810EF</b>	5" Lift and lock with 18" Radius platform with extended foam palm rest
<b>L52319AMGG</b>	5" Lift and lock with 19" platform, articulated mousing surface with green-gel palm rest
<b>L52319MRGG</b>	5" Lift and lock with 19" platform right mousing surface with green-gel palm rest
<b>L523JP10SF</b>	5" Lift and lock with Jules platform with standard foam palm rest
<b>L523SL10SA</b>	5" Lift and lock with Slider platform with standard adjustable palm rest
<b>L726EN10GG</b>	7" Lift and lock with Enviro platform with green-gel palm rest
<b>L72619MRGG</b>	7" Lift and lock with 19" platform, right mousing surface with green-gel palm rest
<b>Stella</b>	
<b>SE</b>	Stella extended, mechanism only
<b>SE23</b>	Stella extended with 23" track
<b>SE231810EF</b>	Stella extended with 18" Radius platform with extended foam palm rest
<b>SE23SL10SA</b>	Stella extended with Slider platform with standard adjustable palm rest
<b>SS</b>	Stella standard, mechanism only
<b>SS20</b>	Stella standard with 20" track
<b>SS201810EF</b>	Stella standard with 18" Radius platform with extended foam palm rest
<b>SS2019AMGG</b>	Stella standard with 19" platform, articulated mousing surface with green-gel palm rest
<b>SS2019MRGG</b>	Stella standard with 19" platform right mousing surface with green-gel palm rest
<b>SS20SL10SA</b>	Stella standard with Slider platform with standard adjustable palm rest
<b>Flat Panel Monitor Arm and Brackets</b>	
<b>CF800</b>	Flat panel standard arm
<b>CFSPC</b>	Flat panel desk-clamp/grommet bracket
<b>FPASINGLECC</b>	FYI single flat panel monitor arm with desk clamp/grommet bracket

## Surface Materials

0835	Black	6153	Pewter
4710	Low Gloss Black	6288	Charcoal
4750	Champagne	7018	Pewter
4799	Platinum	7027	Charcoal
6152	Champagne		

► See *Rapid2 Surface Materials*, page 17

Note: Not all surface materials are available on all Details products. Consult the *Details Specification Guide* for color availability.

## Organizational Worktools



- Help organize flow of work
- Maximize space and increase efficiency
- Help eliminate twisting and reaching by keeping office tools in close proximity
- Provide unique storage solutions for items when not in use
- Available for use on Slatwall, SlatRail, or freestanding
- Work on Steelcase and most non-Steelcase panel systems

### Available Products

Style Number	Description	Style Number	Description
<b>DWBE</b>	Wastebasket	<b>WMB</b>	Markerboard
<b>FTH</b>	Flat top hanger	<b>WPCS</b>	Pen/pencil cup
<b>WBHS</b>	Binder holder	<b>WPFS</b>	PaperFlo manager
<b>WLT12L</b>	12" landscape letter tray	<b>WSPS</b>	Personal shelf
<b>WLTS</b>	10" portrait letter tray	<b>WTCS</b>	Telephone caddy

## Surface Materials

0835	Black	6545	Amber
4750	Champagne	6546	Rain
6000	Black	7018	Pewter
6544	Frost		

► See *Rapid2 Surface Materials*, page 17

Note: Not all surface materials are available on all products. Consult the *Details Specification Guide* for color availability.

## Lighting



- Cost-effective and personalized lighting solutions
- Position light to minimize eye strain and glare

### Available Products

Style Number	Description
<b>LPISA</b>	Pisa task light
<b>PPS6SP</b>	PowerPincher with occupancy sensor

## Surface Materials

7018	Pewter
------	--------

► See *Rapid2 Surface Materials*, page 17

Note: Not all surface materials are available on all Details products. Consult the *Details Specification Guide* for color availability.



**The surface materials listed below are available on the Rapid2 program if:**

- they are normally offered on the product you are ordering and not listed as an exception.

**Seating Upholstery for Steelcase and Turnstone Steelcase Surfaces**

**Brisa (100% polyurethane)**

Price Group 6

<b>BR01</b> Black Onyx	<b>BR10</b> Night Navy
<b>BR04</b> Truffle	<b>BR18</b> New Sand
<b>BR07</b> Sage	

**Buzz2 (100% polyester - yarn used contains less than 100 ppm of antimony)**

Price Group 1

<b>5F03</b> Tomato	<b>5G55</b> Pumpkin
<b>5F05</b> Burgundy	<b>5G56</b> Timber
<b>5F07</b> Blue	<b>5G57</b> Rouge
<b>5F08</b> Navy	<b>5G58</b> Chocolate
<b>5F15</b> Stone	<b>5G59</b> Meadow
<b>5F16</b> Grey	<b>5G60</b> Ivy
<b>5F17</b> Black	<b>5G61</b> Cyan
<b>5G50</b> Dunegrass	<b>5G62</b> Atlantic
<b>5G51</b> Sable	<b>5G63</b> Crocus
<b>5G52</b> Barley	<b>5G64</b> Alpine
<b>5G53</b> Sunrise	<b>5G65</b> Tornado
<b>5G54</b> Carrot	

**Cogent: Connect (antimony\* free polyester)**

Price Group 2

<b>5S15</b> Coconut	<b>5S26</b> Licorice
<b>5S16</b> Turmeric	<b>5S27</b> Malt
<b>5S17</b> Tangerine	<b>5S28</b> Root Beer
<b>5S18</b> Scarlet	<b>5S93</b> Blueprint
<b>5S19</b> Concord	<b>5S94</b> Lizard
<b>5S20</b> Maya Blue	<b>5S95</b> Sailor
<b>5S21</b> Blue Jay	<b>5S96</b> Quicksilver
<b>5S23</b> Wasabi	<b>5S97</b> Nugget
<b>5S24</b> Nickel	<b>5S98</b> Canary
<b>5S25</b> Graphite	<b>5S99</b> Lipstick

**Crosswalk (79% recycled polyester, 31% polyester)**

Price Group 2

<b>5F48</b> Beech	<b>5F53</b> Persimmon
<b>5F49</b> Moon	<b>5F54</b> Bittersweet
<b>5F50</b> Berry	<b>5F55</b> Midnight
<b>5F51</b> Admiral Blue	<b>5F56</b> Poppy
<b>5F52</b> Moss	

**Leather (Sewn models only)**

**L107** Black Leather

\*"Antimony free" is defined by MBDC as having less than 100 ppm per million of any heavy metal of concern.

**Link (100% polyester)**

Price Group 1

<b>5A20</b> Burgundy	<b>5A26</b> Purple
<b>5A23</b> Green	<b>5A27</b> Black
<b>5A24</b> Blue	<b>5A28</b> Ocean
<b>5A25</b> Navy	<b>5A30</b> Chamois

**Nitelights (100% recycled polyester)**

Price Group 2

<b>5F58</b> Hazelnut	<b>5F63</b> Moss
<b>5F59</b> Burgundy	<b>5F64</b> Sea
<b>5F60</b> Cherry	<b>5F65</b> Regal Blue
<b>5F61</b> Earth	<b>5F66</b> Stone
<b>5F62</b> Shore	<b>5F67</b> Moon

**Reply Mesh**

**AR02** Black

**Stand In**

Price Group 2

<b>5621</b> Sleet	<b>5630</b> Apple
<b>5622</b> Lunar	<b>5631</b> Lava
<b>5623</b> Cyclone	<b>5632</b> Cayenne
<b>5624</b> Eclipse	<b>5633</b> Plantain
<b>5625</b> Powder	<b>5634</b> Parley
<b>5626</b> Chardonnay	<b>5635</b> Scallion
<b>5627</b> Graham	<b>5636</b> Atlantis
<b>5628</b> Sediment	<b>5691</b> Orca
<b>5629</b> Allspice	

**3D Knit**

<b>5064</b> Black
<b>5065</b> Coconut
<b>5066</b> Malt
<b>5067</b> Root Beer
<b>5092</b> Graphite

**Hard Materials for Steelcase and Turnstone Steelcase Surfaces**

**Seating Plastic**

<b>6205</b> Black
<b>6249</b> Platinum Solid

**Smooth Paint**

Paint Price Group 1

**4242** Milk

**Textured Paint**

Paint Price Group 1

<b>7207</b> Black
<b>7225</b> Sand
<b>7230</b> Basalt
<b>7238</b> Fieldstone
<b>7241</b> Arctic White
<b>7243</b> Seagull

**Smooth Metallic Paint**

Paint Price Group 2

- 4743** Mineral Metallic
- 4744** Pearl Metallic
- 4750** Champagne Metallic
- 4798** Sterling Metallic
- 4799** Platinum Metallic
- 4803** Near Black Metallic

**Textured Metallic Paint**

Paint Price Group 2

- 7245** Carbon Metallic
- 7246** Midnight Metallic

**Surface Materials for Details**

- |                             |                      |
|-----------------------------|----------------------|
| <b>0835</b> Black           | <b>6288</b> Charcoal |
| <b>4710</b> Low Gloss Black | <b>6544</b> Frost    |
| <b>4750</b> Champagne       | <b>6545</b> Amber    |
| <b>4799</b> Platinum        | <b>6546</b> Rain     |
| <b>6000</b> Black           | <b>7018</b> Pewter   |
| <b>6152</b> Champagne       | <b>7027</b> Charcoal |
| <b>6153</b> Pewter          |                      |

# Rapid5

Effective December 15, 2014



*Featuring Steelcase, Turnstone 1.0 Seating, and Details products manufactured and shipped within 5-7 business days.*

- U.S. electronic price list support:  
December 15, 2014 (180.E)

## Contents

Program Overview	20
How to Order	20
Order Maximums	20
Discounts and Pricing	20
Rapid5 Planner	20

## Product Offering

Systems and Worksurfaces	21
Storage and Other	26
Premium Whiteboards	27
Groupwork	27
Verb	27
Seating	28
Wood Furniture	34
Wood Seating	37
Details	40
Rapid5 Surface Materials	42

Questions?  
Call Steelcase at 1.888.STEELCASE or send an email to  
lineone@steelcase.com (Outside the U.S.A., Canada, Mexico,  
Puerto Rico, and the U.S. Virgin Islands, call 616.247.2500).

# Rapid5

Steelcase, Turnstone 1.0 Seating, & Details

## Program Overview

- The Rapid5 program provides a broad selection of our most popular products with expedited shipping.
- All products are made-to-order and ship within 5-7 business days.
- Rapid5 is targeted for small and mid-market customers whose business needs require fast delivery. Contract market customers can also take advantage of a broad product offering and faster delivery when undertaking people moves and smaller reconfigurations.

### Products Included in Rapid5:

#### Systems and Worksurfaces

- Answer
- Avenir
- c:scape
- Context
- Ellipse
- Kick
- Montage
- Series 9000
- Universal Worksurfaces

#### Storage

- TS 200 Series Laterals
- 800 and 900 Series Laterals
- Universal Storage
- Overfile Cabinets
- Lighting

#### Meeting Spaces

- Premium Whiteboards
- Groupwork
- Verb

#### Seating

- Amia 482 Series
- Cachet 487 Series
- cobl 434 Series
- Criterion 453 Series
- Gesture 442 Series
- Jersey
- Leap 462 Series
- Max Stackers 472 and 473 Series
- Move 490 Series
- Node 480 Series
- Player 475 Series
- Protégé 433 Series
- Reply 466 Series
- Think 465 Series

### Surface Materials Included in Rapid5:

- Over 85 vertical surface fabric choices available
- Over 200 seating upholstery choices available
- 37 laminate choices available
- 27 wood veneer choices available
- 15 paint choices available

► See *Rapid5 Surface Materials*, page 42.

Transitional products and Established and Transitional Surface Materials are not available.

## How to Order

- Orders must be specified and transmitted using the SQ5 electronic catalog to ensure orders are processed quickly.
- Use electronic catalog code: SQ5 Steelcase Rapid5
- Orders cannot be changed or cancelled.
- The Rapid5 program is limited to the models, fabrics, and finishes listed in the SQ5 electronic catalog.
- Consult the specification guide for product details.

## Order Maximums

Product Category	List Price Maximum	or	Maximum Quantity Per Style Number
Systems & Storage	\$ 200,000	or	50 pieces
Seating	\$ 60,000	or	50 pieces
exception Node			10 pieces
Verb	\$ 20,000	or	20 pieces
Wood Furniture	\$ 60,000	or	20 pieces
Wood Seating	\$ 30,000	or	25 pieces
Details Height	\$ 35,000	or	15 pieces
AdjusTable			
Worksurfaces			

Order maximums are calculated by product category. For projects greater than the order maximums, use the standard electronic catalog and work with your Steelcase Solutions Fulfillment Team representative on a delivery schedule. Splitting large orders into smaller orders to get the Rapid5 lead time is not allowed. In the event an order is received that exceeds the maximum list price or maximum style number quantity, the entire order will be moved to standard lead time. For Details products (except Height AdjusTable Worksurfaces), if demand exceeds capacity, then orders are subject to availability.

## Discounts and Pricing

- Contract pricing applies for Rapid5 with no additional pricing premium.

## Rapid5 Planner

### Manufacturing, Shipping, and Delivery Time

Rapid5 orders are manufactured and shipped within 5-7 business days. Delivery is typically 10 business days.

Example:

Day 0	Day 1-4	Day 5-7	Day 10
Steelcase receives complete and clean order before 5:00pm EST.	Order management, materials procurement, order is manufactured.	Order is shipped from manufacturing facility and in transit.	Order is delivered.

Rapid5 orders are manufactured within 5-7 business days and typically deliver within 10 business days (weekends, national holidays, or Steelcase holidays are not included). Orders ship through the Steelcase distribution network. Product mix, dealer profiles, and warehouse scheduled delivery days may impact the actual delivery date. Contact your Steelcase Solutions Fulfillment Team representative for expedited delivery options. Additional charges may apply.

## Answer Solutions

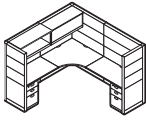

- Answer Solutions includes panels, worksurfaces, and storage.
- Simple to install, expand, shrink and reconfigure, and easily adapts as your organization changes.
- One of the best-selling systems in the market.
- Level 2 certified to the BIFMA e<sup>3</sup> sustainability standard and Silver Cradle to Cradle Certified.

### Available Products

All Answer Solutions products listed below.

#### Panels

- All painted square, oval, and thin trim in-line, L, T, X, V, Y, wall start, end of run, and utility pole, base panel junctions and stacking junctions
- Junction posts, blocks, and inside corner light seals
- Off-module connectors
- All painted thin junction caps, vertical, and change-of-height trims
- Standard and stacking painted square and oval change-of-height trims
- All painted square, oval, and thin trim base and stacking horizontal frame packages
- All tackable and performance tackable acoustical fabric-covered panel skins
- All steel panel skins (plain steel only)
- All slatwall skins and slatwall skin brace packages
- All steel technology skins and covers
- All painted square, oval, and thin trim full skin tackable and performance tackable acoustical panel packages
- All single-pane glass windows
- Cable trays, powerkits, pass-thru powerkits, duplex receptacles, face plate, power-in-feeds (except for use in New York City), hardwired powerkits, power harnesses, modular harnesses, ceiling- and floor-access lay-in utility package, and thin trim utility pole

#### Worksurfaces and Tables

- All Universal Systems worksurfaces and tables with laminate plastic 3 mm edge and wood square edge, legs and supports, except adjustable height
- Answer Freestanding desks, modesty panels, hutch kits, end supports, and corner shelves
- Internode multipurpose power infeeds, modular harnesses, and receptacles

#### Storage

- All Universal fixed and mobile pedestals with flush steel and proud steel fronts, pedestal fillers, and conversion kits, except cushion tops
- All Universal lateral files with flush steel and proud steel fronts, steel and laminate tops
- All Universal overhead storage with flat steel fronts and Universal shelves, except door assist mechanisms and picture frame door inserts
- All Universal towers with flush steel and proud steel fronts, steel and laminate tops, except glass shelves
- All Universal cabinets with flush steel and proud steel fronts, steel and laminate tops, except glass doors
- All Universal bookcases, steel and laminate tops, except with glass doors
- All overfile cabinets
- All Universal laminate storage tops and shelves, except glass shelves
- Duo storage products for use with Answer

#### Lighting

- Utility, Standard, Bottomline, and Underline lights

### Surface Materials

All Rapid5 surface materials are available if they are normally offered on Answer Solutions products and not listed as an exception.

- NO Full-fill finishes
- NO Composite veneer

▶ See *Rapid5 Surface Materials*, page 42.

## Avenir

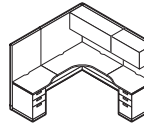
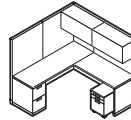

- Panels and panel-supported components, as well as freestanding furniture
- An effective office furniture system with a range of design and price alternatives
- Offers quality, durability, and simplicity

### Available Products

All Avenir products listed below.

#### Panels

- All tackable acoustical panels, except fabric-covered replacement skins and stackers
- Panel connectors and change-of-height connectors
- All L-, T-, and X- configuration fillers, end of run fillers, panel brackets
- Tackboards
- 3-circuit and 4-circuit base power-ins (except for use in New York City), breakaway base power-ins, and end power-ins, 2" x 2" power and cable poles, corner wire covers, cable grommets for base cover, panel-base end filler, all 3-circuit with shared neutral 15-amp receptacles, panel-supported receptacle

#### Worksurfaces and Tables

- All Avenir Universal laminate worksurfaces with plastic 3 mm edge, on-module cantilever support, legs and supports, except adjustable-height legs
- All Avenir laminate worksurfaces (except freestanding), worksurface supports and brackets, laminate radius-end tables, worksurface wiring and cabling
- 8500 Series tables
- Internode multipurpose power infeeds, modular harnesses, and receptacles

#### Storage

- Avenir steel top pedestals and mobile pedestal, except with cushion top
- 200 Series steel top pedestals and mobile pedestal, except with cushion top
- All Universal overhead storage with flat steel fronts, except door assist mechanisms and picture frame door inserts
- Universal shelves and personal shelves
- 800 Series laterals, steel tops

#### Lighting

- Standard shelf and utility lights

### Surface Materials

All Rapid5 surface materials are available if they are normally offered on Avenir and not listed as an exception.

- NO Wood veneer
- NO Full-fill finishes
- NO Composite veneer

▶ See *Rapid5 Surface Materials*, page 42.

## Context

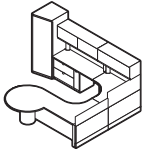

- Freestanding furniture
- Supports teamwork and collaboration, as well as individual needs
- Advanced engineering integrates computers and technology into the workspace

### Available Products

All Context products listed below.

#### Core Units

- All laminate core units, except with dual adjustable-height worksurfaces
- All laminate tables
- All base plates
- Internode multipurpose power infeeds, modular harnesses, and receptacles

#### Storage

- All Universal fixed and mobile pedestals with proud steel front pedestals, except with cushion top
- All Universal lateral files with flush steel and proud steel fronts, steel and laminate tops
- All Universal towers with flush steel and proud steel fronts, steel and laminate tops, except glass shelves and doors
- All Universal cabinets with flush steel and proud steel fronts, steel and laminate tops, except glass shelves
- All Universal laminate storage tops and shelves
- All overhead cabinets, except with assist door mechanism
- All countertops
- All Context steel top pedestals and mobile pedestals, except with cushion top

#### Screens

- All screens, except transition core screen trim

#### Lighting

- Utility and standard shelf lights

### Surface Materials

All Rapid5 surface materials are available if they are normally offered on Context and not listed as an exception.

- Wood veneer
- Full-fill finishes
- Composite veneer

► See *Rapid5 Surface Materials*, page 42.

## c:scape

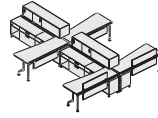

- Specifically designed to create a connected workplace—one that works harder by working smarter.
- Open aesthetic that creates a highly collaborative and socially driven space.
- User-centric design provides little luxuries to the user, offering a great user experience through smaller footprints, delivering on the need to enhance overall real estate value through greater utilization of space.
- Level 2 certified to the BIFMA e<sup>3</sup> sustainability standard and Silver Cradle to Cradle certified.

### Available Products

All c:scape products listed below.

#### Beams

- 72"W, 84"W, and 96"W, except ribbed option
- End of trim, except ribbed option
- L- and T-support feet
- Beam inline connector, beam 90° connector, floor anchor brackets, and seismic anchor brackets

#### Desks and Legs

- All High-Pressure Laminate straight, tapered, and transition desks
- All fixed post leg, fixed L-legs, adjustable-height post leg, and adjustable-height L-leg, except painted legs with polished chrome top (adjustable)
- Desk tether brackets, desk tether bracket and support plate, shared support plate, and back-to-back spacers
- Wire managers and glide pads

#### Storage

##### Mid Storage

- 72"W and 78"W personal tall storage, shared tall storage, wall-mounted tall storage, personal slim storage, shared slim storage, wall-mounted slim storage, including multi-color paint and inline slider (available on tall mid storage)
- Parallel, perpendicular, and mirrored application kits
- Ganging brackets

##### Low Storage

- 30"W and 36"W 1- and 1½-high low storage, including multi-color paint, all case configurations, drawer interiors (rails and divider package), connect zone, counterweights, clean back, and storage-to-beam tether omit brackets
- Rails, divider package, counterweight package, low storage ganging bracket, back-to-back spacers, and lower storage-to-beam tether brackets

#### Screens

- Centered screen custom inserts kits (two brackets and three brackets)

#### Power and Data

All power components are available, except flexible receptacle

### Surface Materials

All Rapid5 surface materials are available if they are normally offered on c:scape products and not listed as an exception.

- Wood veneer
- Full-fill finishes
- Composite veneer

► See *Rapid5 Surface Materials*, page 42.

## Ellipse

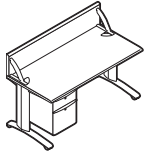

- A freestanding desking system for private and open spaces
- Built-in flexibility supports growth and change
- Elegant European design creates contemporary style and performance—computers are right at home with Ellipse

### Available Products

All Ellipse products listed below.

#### Desks

- All desks (except corner desks and desks with overhead storage), returns, junction tops, conference tables, legs, and transition tops
- Internode multipurpose power infeeds, modular harnesses, and receptacles

#### Screens

- All 12"H screens

#### Storage

- All Universal steel fixed and mobile pedestals with proud steel front pedestals, except with cushion top
- All Universal lateral files with flush steel and proud steel fronts, steel and laminate tops
- All Universal towers with flush steel and proud steel fronts, steel and laminate tops, except glass shelves and doors
- All Universal cabinets with flush steel and proud steel fronts, steel and laminate tops, except glass shelves
- All Universal laminate storage tops and shelves

### Surface Materials

All Rapid5 surface materials are available if they are normally offered on Ellipse and not listed as an exception.

- Wood veneer
- Full-fill finishes
- Composite veneer

▶ See *Rapid5 Surface Materials*, page 42.

## Kick System and Freestanding Metal Desk

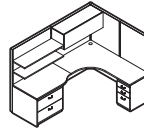

- With all the essentials, walls, desks and storage, Kick is one of the most versatile product lines designed to express your style and meet individualistic needs.
- 120° and 90° multiple heights and widths, to increase planning options to meet unique needs.
- Configurations are limitless with Kick. Tackable, acoustic, glass, perforated steel options on monolithic segmented or stacking panels, along with the ability to blend Kick provide several options at many price points.
- Durability, flexibility, and ease of change make Kick a wise investment. Replaceable panel skins and inserts along with a simple universal connector.

### Available Products

#### Panels

- All tackable acoustical, perforated, and glass panels
- All segmented panels
- All panel stackers
- All panel frames and inserts
- All panel trim, panel connectors, and wiring and cabling
- Kick sliding panel doors

#### Universal Systems Worksurfaces

- All straight, transition, straight corner, corner and extended corner curved, split corner, peninsula, spanner, visitor and linking, and transaction worksurfaces, laminate plastic 3 mm edge or wood square edge
- Worksurface-height power
- Worksurface legs and supports

#### Freestanding Metal Desk

- Desk shells, single-pedestal desks, double-pedestal desks, and curved corner desks
- Returns and single-pedestal returns
- Bridges
- Peninsula worksurfaces
- Overhead storage cabinets and tackboards

#### Storage

- TS Series over the case bins with flat or radius fronts
- TS Series laminate common shelf
- TS Series under-worksurface pedestals and mobile pedestals
- TS 200 Series lateral files and under-worksurface laterals
- TS Series Tower Too

#### Lighting

- Utility, Standard, LED shelf, and personal lights

### Surface Materials

All Rapid5 surface materials are available if they are normally offered on Kick.

- Full-fill finishes
- Composite veneer

▶ See *Rapid5 Surface Materials*, page 42.



## Montage Solutions

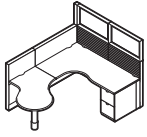

- Montage Solutions includes panels, worksurfaces, and storage.
- Stackable frame-and-tile system lets you create the look you want with the performance you need.
- Unmistakable style. Unlimited possibilities.
- MBDC Silver Cradle to Cradle Certified

### Available Products

All Montage Solutions products listed below.

#### Panels

- Enhanced standard, monolithic, and enhanced off-module frames
- Door frames and lever sets
- Frame junction kits
- Horizontal filler strips
- All power components, except 20-amp receptacles, off-modular electrical components, and light cable components
- All enhanced monolithic tackable acoustical tiles, enhanced non-tackable, tackable acoustical and high-performance acoustical tiles, laminate tiles, and slatwall tiles

#### Worksurfaces and Tables

- All Universal Systems worksurfaces and tables with laminate plastic 3 mm edge and wood square edge, legs and supports, except adjustable height
- Answer Freestanding desks, modesty panels, hutch kits, end supports, and corner shelves
- Internode multipurpose power infeeds, modular harnesses, and receptacles

#### Storage

- All Universal fixed and mobile pedestals with flush steel and proud steel fronts, pedestal fillers and conversion kits, except cushion tops
- All Universal lateral files with flush steel and proud steel fronts, steel and laminate tops
- All Universal overhead storage with flat steel fronts and Universal shelves, except door assist mechanisms and picture frame door inserts
- All Universal towers with flush steel and proud steel fronts, steel and laminate tops, except glass shelves
- All Universal cabinets with flush steel and proud steel fronts, steel and laminate tops, except glass doors
- All Universal bookcases, steel and laminate tops, glass doors
- All overfile cabinets
- All Universal laminate storage tops and shelves, except glass shelves
- Duo storage products for use with Montage

#### Lighting

- Utility, Standard, Bottomline, and Underline lights

### Surface Materials

All Rapid5 surface materials are available if they are normally offered on Montage Solutions products.

- Full-fill finishes
- Composite veneer

▶ See *Rapid5 Surface Materials*, page 42.

## Series 9000

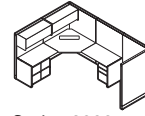

Series 9000

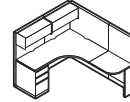

9000 Options

- Panels and panel-supported components, as well as freestanding furniture
- Sets the industry standard for performance—durable, flexible, supports technology, offers virtually unlimited applications
- Continually enhanced and updated to respond to evolving office needs

### Available Products

All Series 9000 products listed below.

#### Panels

- All enhanced tackable acoustical panels, except fabric-covered replacement skins
- Enhanced painted panel trim and end-of-run filler packages
- All enhanced fabric-covered fillers packages, except X-configuration and top cap
- Panel brackets, except anchor bracket
- Tackboards
- 3-circuit and 4-circuit base power-ins (except for use in New York City), breakaway base power-ins, and end power-ins, power and cable poles, all 3-circuit with shared neutral 15-amp receptacles, panel-supported receptacle

#### Worksurfaces

- All Series 9000 Universal Systems laminate worksurfaces with plastic 3 mm edge, on-module cantilever and center supports, legs and supports, except adjustable-height legs
- All conventional laminate worksurface packages and freestanding worksurfaces, except radius-end tables, and brackets and clamps
- Series 9000 Options worksurfaces and supports, except adjustable split top
- Internode multipurpose power infeeds, modular harnesses, and receptacles

#### Storage

- Series 9000 pedestals and mobile pedestal, except with cushion top
- All Universal overhead storage with flat steel fronts for use with Series 9000, except door assist mechanisms and picture frame door inserts
- Universal shelves, personal shelves, and slim shelves
- Service module packages
- Series 9000 Options pedestals

#### Lighting

- Standard shelf and Utility lights

### Surface Materials

All Rapid5 surface materials are available if they are normally offered on Series 9000 and not listed as an exception.

- Wood veneer
- Full-fill finishes
- Composite veneer

▶ See *Rapid5 Surface Materials*, page 42.



## Universal Worksurfaces

### Available Products

- All Universal Systems worksurfaces and tables with laminate plastic 3 mm edge and wood square edge and legs and supports, except adjustable height

### Surface Materials

**All Rapid5 surface materials** are available if they are normally offered on Universal Worksurfaces.

**NO** Full-fill finishes

**NO** Composite veneer

- ▶ See *Rapid5 Surface Materials*, page 42.

# Storage and Other, Rapid5

## TS 200 Series Laterals

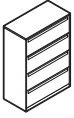

- Excellent support for paper storage needs
- Durable construction, packed with value
- Styled to work in a variety of office settings
- Full-width pulls on TS 200 Series files complement Steelcase systems

### Available Products

- ▶ All TS 200 Series laterals and laterals with lift-up doors and roll-out shelves with steel and laminate tops

### Surface Materials

All **Rapid5 surface materials** are available if they are normally offered on 200 Series.

- ▶ See *Rapid5 Surface Materials*, page 42.

## 800 and 900 Series Lateral Files and Cabinets

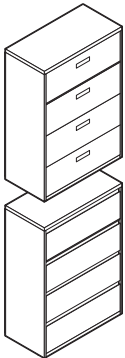

- Comprehensive storage solutions for paper and other media
- 800 Series design complements Avenir systems furniture
- 900 Series design matches Series 9000 systems furniture

### Available Products

All **800 and 900 Series lateral files with locks, cabinets, options, and accessories** in the current electronic specification guide are available, except:

- NO Laminate or veneer tops

### Surface Materials

All **Steelcase Rapid5 surface materials** are available if they are normally offered on 800 and 900 Series lateral files and cabinets and not listed as an exception.

- ▶ See *Rapid5 Surface Materials*, page 42.

## Overfile Cabinets

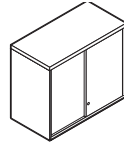

- Fit on top of lateral files or storage cabinets to provide additional storage
- Neutral aesthetic that complements systems furniture and storage

### Available Products

All **900 Series overfile cabinets options, and accessories** in the current electronic specification guide are available.

### Surface Materials

All **Rapid5 surface materials** are available if they are normally offered on Overfile Cabinets.

- ▶ See *Rapid5 Surface Materials*, page 42.

## Universal Storage

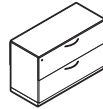

- Award-winning, comprehensive, freestanding storage platform that supports greater versatility in planning and applying storage solutions
- Integrates with Steelcase's broad offering of panel-based and freestanding systems
- Designed to grow and change with user needs

### Available Products

- All Universal towers with flush steel and proud steel fronts, steel and laminate tops, except glass shelves
- All Universal lateral files with flush steel and proud steel fronts, steel and laminate tops
- All Universal cabinets with flush steel and proud steel fronts, steel and laminate tops, except glass doors
- All Universal bookcases, steel and laminate tops, except glass doors
- All Universal fixed and mobile pedestals with flush steel and proud steel fronts, pedestal fillers, and conversion kits for use with Answer and Montage, except cushion tops
- All Universal overhead storage with flat steel fronts and Universal shelves for use with Answer and Montage, except door assist mechanisms and picture frame door inserts
- All overfile cabinets
- All Universal laminate storage tops and shelves, except glass shelves

### Surface Materials

All **Rapid5 surface materials** are available if they are normally offered on Universal Storage.

- ▶ See *Rapid5 Surface Materials*, page 42.

## Premium Whiteboards

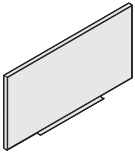

- e<sup>3</sup> environmental ceramicsteel writing surface on markerboards
- Clear anodized aluminum frame
- Pack of four dry-erase markers (black, blue, red, and green) and one eraser

### Available Products

#### Edge Series Whiteboard

<b>CEDM032</b>	36"W x 24"H
<b>CEDM043</b>	48"W x 36"H
<b>CEDM044</b>	48"W x 48"H
<b>CEDM054</b>	60"W x 48"H
<b>CEDM064</b>	72"W x 48"H
<b>CEDM084</b>	96"W x 48"H

#### 110 Series Whiteboard

<b>M1140044</b>	48"W x 48"H
<b>M1140064</b>	72"W x 48"H
<b>M1140084</b>	96"W x 48"H
<b>M1140124</b>	144"W x 48"H

### Surface Materials

- All Rapid5 surface materials** are available if they are normally offered on Premium Whiteboards.
- Available in clear anodized aluminum frame only.
  - ▶ See *Rapid5 Surface Materials*, page 42.

## Groupwork

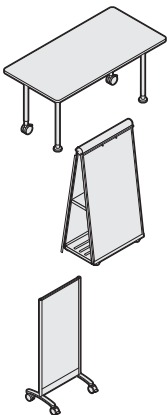

- Groupwork furniture includes screens, easels, and tables
- Supports team activities
- Appropriate in an open plan and enclosed workspace
- Table tops and table legs are ordered separately

### Available Products

- All Groupwork tables, table legs, and modesty panels
- All Groupwork easels, Workwell, markerboards, and tackboards
- All Groupwork screens and screen accessories

### Surface Materials

- All Rapid5 surface materials** are available if they are normally offered on Groupwork.

## Verb

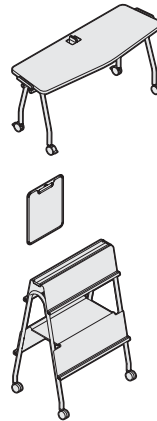

- An integrated, mobile collection of classroom furniture designed to support a range of teaching and learning styles on demand.
- Portfolio consist of teaching stations, tables, easels, and wall tracks.

### Available Products

- All Verb style numbers in the electronic specification guide are available.

### Surface Materials

- All Rapid5 surface materials** are available if they are normally offered on Verb and not listed as an exception.
- ▶ See *Rapid5 Surface Materials*, page 42.

## Lighting



### Available Products

- Utility, Standard, Bottomline, and Underline lights

### Surface Materials

- All Rapid5 surface materials** are available if they are normally offered on Lighting.
- ▶ See *Rapid5 Surface Materials*, page 42.

# Seating, Rapid5

## Amia 482 Series



- LiveLumber™ system allows for continuous back support with dialed in spring force that can be adjusted to match the user's anatomy
- Features an ergonomic chair at a value price point
- Up to 97% recyclable

### Available Products

Style Number	Description
<b>4821410</b>	Chair, upholstery on back and seat, with 4" and 7" pneumatic seat-height adjustment
<b>4821410F</b>	Chair, upholstery on back and seat, with 4" and 7" pneumatic seat-height adjustment with fire code
<b>4821410K</b>	Chair, unassembled, upholstery on back and seat, with 4" and 7" pneumatic seat-height adjustment
<b>4827410</b>	Stool, with upholstery on seat and back
<b>4827410F</b>	Stool, with upholstery on seat and back, and back with fire code

### Surface Materials

All Rapid5 surface materials are available if they are normally offered on Amia.

**NO** Leather

▶ See *Rapid5 Surface Materials*, page 42.

## Cachet 487 Series



- A lightweight, extremely comfortable multi-purpose/guest chair
- Features a unique mechanism allowing the chair to recline in response to user's weight
- Offers seat height adjustability

### Available Products

Style Number	Description
<b>4871110</b>	Work chair, swivel base, without upholstery
<b>4877110</b>	Stool, swivel base, without upholstery
<b>4878100</b>	Multi-use chair, leg-base without arms, without upholstery
<b>4878110</b>	Multi-use chair, leg-base with flip-up arms, without upholstery

### Surface Materials

All Rapid5 surface materials are available if they are normally offered on Cachet.

▶ See *Rapid5 Surface Materials*, page 42.

## cobi 434 Series



- Collaborative chair for teams that helps people move freely, change postures, stay energized, and comfortable
- Flexing fingers in back offer support while moving and conforming to the user
- Flexible seat edge on all three sides supports multiple postures while relieving thigh pressure

### Available Products

Style Number	Description
<b>434110</b>	Swivel base, armless
<b>434110S</b>	Swivel base, armless, sewn
<b>434111</b>	Swivel base, fixed arms
<b>434111S</b>	Swivel base, fixed arms, sewn
<b>434710</b>	Swivel stool, armless
<b>434710S</b>	Swivel stool, armless, sewn
<b>434711</b>	Swivel stool, fixed arms
<b>434711S</b>	Swivel stool, fixed arms, sewn

### Surface Materials

All Rapid5 surface materials are available if they are normally offered on cobi.

▶ See *Rapid5 Surface Materials*, page 42.

## Criterion 453 Series



- A high-performance chair, ideal for users who sit for long periods of time
- One of the world's best-selling chairs, with a broad range of adjustments
- Meets the long-term comfort needs of today's diverse workforce

### Available Products

All Criterion 453 Series seating products and options in the current electronic specification guide are available.

- All mid-back and high-back chairs and stools without arms, fully upholstered, adjustable seat depth, and fire code, except non-sewn, sewn, and leather
- All mid-back and high-back chairs and stools with fixed-height arms, height- and width adjustable arms, height-, width-, and pivot-adjustable arms, fully upholstered, adjustable seat depth and fire code, except non-sewn, sewn, and leather

### Surface Materials

All Rapid5 surface materials are available if they are normally offered on Criterion 453 Series and not listed as an exception.

**NO** Leather

**NO** Non-sewn seat upholstery

**NO** 9201 Polished Chrome stool foot ring

▶ See *Rapid5 Surface Materials*, page 42.

## Gesture 442 Series



- The first chair designed to support our interactions with today's technologies. Inspired by the movement of the human body. Created for the way we work today.
- 3D LiveBack allows the back to move and conform laterally, sagittally, and torsionally to support individual users.
- Designed to support posture changes specifically influenced by technology devices we use today.

### Available Products

All **Gesture 442 Series** style numbers in the electronic specification guide are available.

### Surface Materials

All **Rapid5 surface materials** are available if they are normally offered on Gesture and not listed as an exception.

 Fire Code

► See *Rapid5 Surface Materials*, page 42.

## Jersey



- Performance, comfort and award-winning design
- Features double mesh back in a unique "S" shape for comfort and support
- Offers nine back mesh colors and six stretch pullovers that make it easy to change the look
- Design by Brian Kaneomfort needs of today's diverse workforce

### Available Products

Style Number	Description
<b>TS38301</b>	Work chair, mesh back, and upholstered seat
<b>TS38304</b>	Multi-use chair with arms, mesh back, and upholstered seat
<b>TS38305</b>	Multi-use chair without arms, mesh back, and upholstered seat
<b>TS38308</b>	Multi-use chair with arms, with casters, mesh back, and upholstered seat
<b>TS38309</b>	Multi-use chair without arms, with casters, mesh back, and upholstered seat
<b>JERSEYV</b>	Work chair, with black mesh on back with Buzz2 fabric on seat

### Surface Materials

All **Rapid5 surface materials** are available if they are normally offered on Jersey.

► See *Rapid5 Surface Materials*, page 42.

## Leap 462 Series



- High-performance work chair with exceptional adjustability
- Innovative features such as Natural Glide System and Live Back
- Offers tremendous design flexibility

### Available Products

Style Number	Description
<b>46216179</b>	Chair with upholstery on seat and back
<b>46216179F</b>	Chair with upholstery on seat and back with fire code
<b>46267179</b>	Stool with upholstery on seat and back
<b>46267179F</b>	Stool with upholstery on seat and back
<b>LEAPV2</b>	Chair with Buzz2 fabric on seat and back

### Surface Materials

All **Rapid5 surface materials** are available if they are normally offered on Leap.

► See *Rapid5 Surface Materials*, page 42.

## Max-Stacker 472 Series



- Provides stackable seating for high-traffic applications
- Clean lines, durable steel rod frame, and upholstery options have made the Max-Stacker a universally popular stacker selection
- Depending on style, can stack 45 high

## Max-Stacker II 473 Series



- A great stacking chair that can be used in many different areas
- Offers a different visual appeal, with a rounded back and curved lines
- Provides improved back support and optional cushioning for longer-term comfort
- Depending on style, can stack 35 high

### Available Products

Style Number	Description
<b>472410</b>	Without arms, polished chrome frame
<b>472410N</b>	Without arms, coated frame
<b>473410</b>	Without arms, polished chrome frame
<b>473410N</b>	Without arms, coated frame
<b>473410NU</b>	Without arms, coated frame, upholstered cushion

### Surface Materials

All **Rapid5 surface materials** are available if they are normally offered on Max Stackers.

► See *Rapid5 Surface Materials*, page 42.

## Move 490 Series



- Guest chair that also stacks
- Features innovative Live dynamic seat
- Simple design

### Available Products

Style Number	Description
<b>490410</b>	Multi-use chair, plastic back without arms, with glides
<b>490410C</b>	Multi-use chair, plastic back without arms, with casters
<b>490410CF</b>	Multi-use chair, plastic back without arms, with casters with fire code
<b>490410V</b>	Multi-use chair, without arms, with Buzz2 fabric on seat, with glides
<b>490410VC</b>	Multi-use chair, without arms, with Buzz2 fabric on seat, with casters
<b>490410VCF</b>	Multi-use chair, without arms, with Buzz2 fabric on seat, with casters with fire code
<b>490412</b>	Plastic back with arms, upholstered seat, with glides
<b>490412C</b>	Plastic back with arms, upholstered seat, with casters

### Surface Materials

All Rapid5 surface materials are available if they are normally offered on Move.

▶ See *Rapid5 Surface Materials*, page 42.

## Node 480 Series

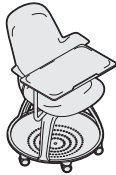

- Collaborative seating for classrooms and learning environments
- Supports multiple learning modes
- Freedom to change posture
- Storage of students' belongings

### Available Products

Style Number	Description
<b>480110</b>	Chair, without personal worksurface
<b>480120</b>	Chair, with personal worksurface
<b>480210</b>	Chair, mid-back without personal worksurface
<b>480220</b>	Chair, mid-back with personal worksurface

### Surface Materials

#### Metal components

0835 Black paint  
4799 Platinum Metallic paint

#### Shell

6205 Black  
6333 Picasso  
6335 Wasabi  
6336 Jazz

#### Tripod Base

6249 Platinum

#### Worksurface

6249 Platinum  
6259 Near Black

## Player 475 Series



- Guest chair that also stacks
- Strength features in the back, arms, and back legs make Player a logical choice for high-traffic areas
- Simple, classic design complements a broad range of work settings

### Available Products

Style Number	Description
<b>475410M</b>	Chair, leg-base, without arms, with glides
<b>475412M</b>	Chair, leg-base, with smooth plastic arms, with glides
<b>475412MC</b>	Chair, leg-base, with smooth plastic arms, with casters
<b>475480M</b>	Chair, sled-base, without arms
<b>475482M</b>	Chair, sled-base, with smooth plastic arms
<b>475710M</b>	Stool, leg-base, without arms
<b>475712M</b>	Stool, leg-base, with smooth plastic arms

### Surface Materials

All Rapid5 surface materials are available if they are normally offered on Player.

▶ See *Rapid5 Surface Materials*, page 42.

## Protégé 433 Series



- An economic, general-use solution with basic ergonomic features
- Stylish, comfortable, and well-suited for a wide range of tasks including moderate computer use

### Available Products

Style Number	Description
<b>4331203</b>	Chair without arms
<b>4331203U</b>	Chair without arms, fully upholstered outer back and outer seat
<b>4331223</b>	Chair with arms and soft arm caps
<b>4331223U</b>	Chair with arms and soft arm caps, fully upholstered outer back and outer seat
<b>4331403</b>	Chair without arms
<b>4331423</b>	Chair with arms and soft arm caps, with back lock
<b>4331423U</b>	Chair with arms and soft arm caps, fully upholstered outer back and outer seat, back lock
<b>PROTEGEV</b>	Chair with Buzz2 fabric on seat and back

### Surface Materials

All Rapid5 surface materials are available if they are normally offered on Protégé.

▶ See *Rapid5 Surface Materials*, page 42.

## Reply 466 Series



- Synchro-tilt mechanism
- 5" pneumatic seat-height adjustment (16" – 21")
- Multi-position back lock
- Outer back, seat shell, and five-arm plastic base: plastic
- 1½" seat depth adjustment
- 2½" diameter, hard-composition, dual-wheel casters, black

### Available Products

Style Number	Description
<b>466160MP</b>	Task chair, with standard upholstery on seat and back, height-adjustable arms, soft arm caps, with soft or hard casters
<b>466160MPF</b>	Task chair, with standard upholstery on seat and back, height-adjustable arms, soft arm caps, with soft or hard casters, with fire code
<b>466160MT</b>	Task chair, mesh back with standard upholstery on seat, height-adjustable arms, soft arm caps, and 4" lumbar height with soft or hard casters
<b>466450MH</b>	Leg-base multi-use chair, standard upholstery on seat and back, without arms, hard or soft glides
<b>466450MHF</b>	Leg-base multi-use chair, standard upholstery on seat and back, without arms, hard or soft glides, with fire code
<b>466450MT</b>	Leg-base multi-use chair, mesh back with standard upholstery on seat, without arms, hard or soft glides
<b>466452MH</b>	Leg-base multi-use chair, standard upholstery on seat and back, arms, hard or soft glides
<b>466452MHF</b>	Leg-base multi-use chair, standard upholstery on seat and back, arms, hard or soft glides, with fire code
<b>466452MT</b>	Leg-base multi-use chair, mesh back with standard upholstery on seat, with arms, hard or soft glides
<b>466480MH</b>	Sled-base multi-use chair, standard upholstery on seat and back, without arms, hard or soft glides
<b>466480MHF</b>	Sled-base multi-use chair, standard upholstery on seat and back, without arms, hard or soft glides, with fire code
<b>466480MT</b>	Sled-base multi-use chair, mesh back with standard upholstery on seat, without arms, hard or soft glides
<b>466482MH</b>	Sled-base multi-use chair, standard upholstery on seat and back, with arms, hard or soft glides
<b>466482MHF</b>	Sled-base multi-use chair, standard upholstery on seat and back, with arms, hard or soft glides, with fire code
<b>466482MT</b>	Sled-base multi-use chair, mesh back with standard upholstery on seat, with arms, hard or soft glides

### Surface Materials

#### Reply Mesh

- AR01 Grey
- AR02 Black
- AR04 Red
- AR06 Apple Green
- AR09 Sable

#### Seating Plastic

- 6205 Black
- 6249 Platinum

All Rapid5 seating upholstery is available if they are normally offered on Reply.

► See *Rapid5 Surface Materials*, page 42.

## Think 465 Series



- The chair with a brain and conscience
- Your preference back control provides four settings for personal preference and work style
- Standard with seat depth and passive seat edge flex
- Height-, pivot-, and depth-adjustable arms

### Available Products

Style Number	Description
<b>46540000</b>	Chair, armless, standard upholstery
<b>46540000F</b>	Chair, armless, standard upholstery with fire code
<b>46540000K</b>	Chair, unassembled, armless, standard upholstery
<b>46540100</b>	Chair, with arms, standard upholstery
<b>46540100F</b>	Chair, with arms, standard upholstery with fire code
<b>46540100K</b>	Chair, unassembled, with arms, standard upholstery
<b>46543000</b>	Chair, armless, 3D Knit with standard upholstery on seat
<b>46543000F</b>	Chair, armless, 3D Knit with standard upholstery on seat with fire code
<b>46543000K</b>	Chair, unassembled, 3D Knit with standard upholstery on seat
<b>46543100</b>	Chair, with arms, 3D Knit with standard upholstery on seat
<b>46543100F</b>	Chair, with arms, 3D Knit with standard upholstery on seat with fire code
<b>46543100K</b>	Chair, unassembled, with arms, 3D Knit with standard upholstery on seat
<b>46530000</b>	Stool, armless, 3D Knit with standard upholstery on seat
<b>46530000F</b>	Stool, armless, 3D Knit with standard upholstery on seat with fire code
<b>46530100</b>	Stool, with arms, standard upholstery
<b>46530100F</b>	Stool, with arms, standard upholstery with fire code
<b>46533000</b>	Stool, armless, 3D Knit with standard upholstery on seat
<b>46533000F</b>	Stool, armless, 3D Knit with standard upholstery on seat with fire code
<b>46533100</b>	Stool, with arms, 3D Knit with standard upholstery on seat
<b>46533100F</b>	Stool, with arms, 3D Knit with standard upholstery on seat with fire code

*Exception: Headrest and enclosed back option not available on all Think models.*

### Surface Materials

All Rapid5 surface materials are available if they are normally offered on Think.

► See *Rapid5 Surface Materials*, page 42.



# Turnstone 1.0 Seating, Rapid5

## à la carte



- Function, style, and comfort in a value-priced chair
- A refined design, with round and square tapered backs
- Swivel mechanism
- Pneumatic height adjustment
- Adjustable seat depth via the back

### Available Products

Style Number	Description
<b>TS30101</b>	Modified round-back task chair, mid-back
<b>TS30101M</b>	Modified round-back task chair, mid-back, multiple fabric
<b>TS30102</b>	Round-back task chairs, mid-back
<b>TS30102M</b>	Round-back task chairs, mid-back, multiple fabric
<b>TS30103</b>	Round-back task chairs, high-back
<b>TS30103M</b>	Round-back task chairs, high-back, multiple fabric
<b>TS30104</b>	Round-back guest chair
<b>TS30104M</b>	Round-back guest chair, multiple fabric
<b>TS30105</b>	Square-back task chairs, mid-back
<b>TS30105M</b>	Square-back task chairs, mid-back, multiple fabric
<b>TS30106</b>	Square-back task chairs, high-back
<b>TS30106M</b>	Square-back task chairs, high-back, multiple fabric
<b>TS30107</b>	Square-back guest chair
<b>TS30107M</b>	Square-back guest chair, multiple fabric

### Surface Materials

All **Rapid5 surface materials** are available if they are normally offered on à la carte and not listed as an exception.

Leather

▶ See *Rapid5 Surface Materials*, page 42.

## Crew



- Full-back task chair
- Synchro-tilt mechanism
- Pneumatic height adjustment
- Upright back lock
- Tilt tension
- Back height adjustment
- Upholstered seat and inner back
- Black frame

### Available Products

- All full-back task chairs
- All full-back task chairs with seat depth
- All full-back task stools
- All guest chairs

### Surface Materials

All **Rapid5 surface materials** are available if they are normally offered on Crew and not listed as an exception.

Fire Code

Leather

▶ See *Rapid5 Surface Materials*, page 42.

## Domino

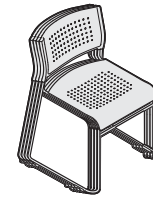

- Frame: black
- Shell: 6205 black plastic
- Glides that gang
- Package of four

### Available Products

Style Number	Description
<b>TS37101</b>	Stack chair, package of four
<b>TS37102</b>	Seat and back cushions, package of four
<b>TS37104</b>	Seat cushions, package of four

### Surface Materials

All **Rapid5 surface materials** are available if they are normally offered on Domino.

▶ See *Rapid5 Surface Materials*, page 42.



## Jacket Task Chair



- Synchro-tilt mechanism
- Pneumatic height adjustment
- Tilt tension
- Adjustable seat depth via the back
- Height- and maintenance width-adjustable arms
- Leather chair

### Available Products

Style Number	Description
TS31301	Desk chair
TS31302	Jacket cover

### Surface Materials

All Rapid5 surface materials are available if they are normally offered on Jacket.

▶ See *Rapid5 Surface Materials*, page 42.

## Uno



- Hammock-style support
- Pneumatic height adjustment
- Swivel mechanism
- Mid-back or high-back
- Upholstered seat and back
- Outer back: black plastic
- Hard dual-wheel casters

### Available Products

Style Number	Description
TS31101	Multi-purpose chair, mid-back
TS31102	Multi-purpose chair, high-back

### Surface Materials

All Rapid5 surface materials are available if they are normally offered on Uno and not listed as an exception.

- NO Fire Code
- NO Leather

▶ See *Rapid5 Surface Materials*, page 42.

# Wood Furniture, Rapid5

## Convене

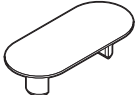

- A complete portfolio of meeting space products that includes a vast collection of conference tables, credenzas, lecterns, hospitality and media carts, and wallboards, designed in various options to complement contemporary, traditional and transitional office decor.

### Available Products

- Wood conference tabletops in rectangle, racetrack, and boat shape in sizes 48" x120" and smaller
- Wood round table tops 54" and smaller
- All power and communication options, except for power channels and CPC and CPCRL power options
- 24" and 30" T- and X-flex bases
- 18" and 24" rectangle bases with toe kick

### Surface Materials

**All Rapid5 surface materials** are available if they are normally offered on Convене.

- ▶ See *Rapid5 Surface Materials*, page 42.

## Currency

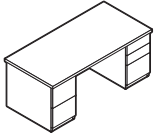

### Available Products

#### Desks, Shells, Worksurfaces, Bridges, Slatwall, and Workwall

- All desks, rectangular desk shells, bow-front desk shells, extended curved corner desk shells, and curved corner desk shells
- Returns and return shells
- All D-, P-, rectilinear-shape worksurfaces
- All bridges
- Worksurface-height power and communication access
- All slatwall screens and slatwall tackboards
- All workwall

#### Storage

- All credenza, pedestals, and lateral files
- All storage cabinets, overhead storage, wall-mounted storage cabinets, and tackboards
- All bookcases
- 18"W and 24"W towers
- Corner shelf unit and mobile cart

#### Tables

- Rectangular table tops
- Table legs and supports

#### Lighting

- All standard shelf lights

### Surface Materials

**All Rapid5 surface materials** are available if they are normally offered on Currency.

- ▶ See *Rapid5 Surface Materials*, page 42.

## Elective Elements

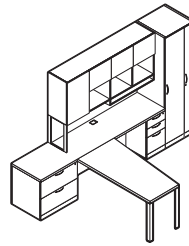

- Available in panel-mounted, freestanding, or private office applications
- All wood, laminate with wood combination, and laminate components are offered
- Wide range of worksurface profiles and pull options on storage to address the desired aesthetic
- Extensive statement of line in worksurfaces and storage address specific needs of customers

### Available Products

#### Worksurfaces and Supports

- All wood, laminate and laminate with wood combination worksurfaces including straight, desk, return, desk return, bridge, transition, single tapered, tapered, bullet, keyhole, P-top, angled, meeting, extended bullet, spanner, corner, extended corner, Montage transaction, and personal table top worksurfaces, except Answer transaction tops and perpendicular tether supports.
- All worksurface accessories
- All wood and laminate worksurface supports including back panels, modesty panels, technology modesty panels, filler panels, end panels, T-shape and L-shape end panels, corner support panels, and center support panels.
- All metal base supports with the exception of adjustable-height legs
- All accessories for supports
- All plinth base supports
- All edge profiles except blade
- No leg base products

#### Storage

- All wood, laminate and laminate with wood combination storage components including pedestals, lateral files, overhead cabinets, shelves, hutch kits, select tackboards, wood panels with slatwall, bookcases, towers, vertical cabinets and wardrobes, except cushion tops, glass doors, and adjustable-height pedestals, except 1.5 high storage.
- All plinth base storage
- All pulls are available except transitional and inset
- Metal shelf option is not available
- No leg base products

#### Electrical and Cable Management

- All electrical and cable management components, except convenience tri-receptacle with power cord and plug, convenience communication outlet housing, above worksurface clamp kit, below worksurface mounting bracket, vertebral cable riser and extension, skeleton bone wire manager and extension and flip-up power unit.

### Surface Materials

**All Rapid5 surface materials** are available if they are normally offered on Elective Elements and not listed as an exception.

- Composite veneers

- ▶ See *Steelcase Rapid5 Surface Materials*, page 42.

## Garland

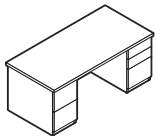

- Garland offers elegant transitional styling with impeccable detail and an array of options.
- Broad offering supports large and small scale private office applications.
- Cockpit configurations provide curvilinear worksurfaces.
- Six-inch module makes it easy to plan.

### Available Products

#### Desks and Tables

- All desks, cockpit configuration desks and bullets, bullet run-offs, bullet tables, and p-shape tables, desk returns, returns, bridges, and corner units, with the exception flip up power units

#### Storage

- All sizes of full storage kneespace credenzas, and shell credenzas
- Mobile pedestal
- All lateral files
- All service modules, except with glass doors
- All tackboards
- Light valances
- Desktop organizers and back panels for desktop organizers
- Stacking and freestanding bookcases
- Vertical cabinets, wardrobes and towers
- Consultation tables
- Header

### Surface Materials

**All Rapid5 surface materials** are available if they are normally offered on Garland.

## Classic and Executive Payback

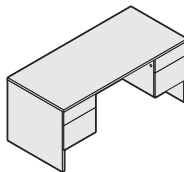

- A contemporary design. Clean lines and timeless design ensure years of use for meeting rooms to private offices.
- Desks, returns, credenzas, and storage components are shipped fully assembled.
- Desk shells and D-, P-, and rectilinear-shape worksurfaces are shipped knocked down for assembly in field using quick-connect assembly hardware.
- Classic Payback worksurfaces are standard 1" thick with a square edge profile.
- Executive Payback worksurfaces are standard 1½" thick with a ribbed edge profile.

### Available Products

#### Desks

- All desks and desk-height returns
- All reception desks and returns
- All desk shells: rectangular, extended corner, corner, and notched
- All jetty desk shells
- All reception galleries and tackboards (check on tackboards)
- All bridges

#### Worksurfaces

- All D-, P-, Rectilinear-shape worksurfaces
- All credenzas

#### Storage

- All pedestals and mobile pedestals
- Lateral files
- Storage cabinets
- Overhead storage cabinets
- Tackboards
- Wall-mounted overhead storage cabinets and tackboards
- Slatwall screens and tackboards
- Storage and wardrobe cabinets
- Bookcases and quarter-round bookcases

#### Conference Room Furniture

- Wall markerboard and video cabinets
- Lecterns and meeting room service carts

#### Tables

- Table tops, bases, and legs
- Modesty panels
- Printer table, spanner table, and extension tables

#### Lighting

- All standard shelf lights

### Surface Materials

**All Rapid5 surface materials** are available if they are normally offered on Payback. ▶  
See *Steelcase Rapid5 Surface Materials*, page 42.

## Walden

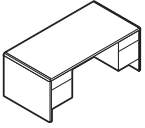

- Walden offers contemporary styling interpreted in a simple aesthetic with great design.
- Supports large and small scale private office applications, shared private offices, and basic open plan freestanding.
- Six-inch module makes it easy to plan.

### Available Products

#### Desks and Tables

- All laminate and wood desks, table desks, straight, bullet run-offs, bullet-shape tables, desk returns, returns and bridge, modesty panels, and corner units, with the exception of flip-up power units

#### Storage

- All laminate and wood sizes of full-storage, knee-space, and shell credenzas
- Mobile pedestal
- Wood lateral files
- Wood service modules, except with glass doors
- All tackboards
- Light valances
- Laminate and wood desktop organizers and back panels for desktop organizers
- Wood stacking and freestanding bookcases
- All wood vertical cabinets, wardrobes, and towers

### Surface Materials

**All Rapid5 surface materials** are available if they are normally offered on Walden.

- ▶ See *Rapid5 Surface Materials*, page 42.

## Alcove

Wood Seating



- Contemporary guest chair with upholstered seat and back
- Frame is European beech wood
- Arms are one-piece solid wood construction and form a gentle curve to provide comfortable seating

### Available Products

Style Number	Description
<b>G20</b>	Guest chair, with arms, upholstered seat and back

### Surface Materials

All Rapid5 surface materials are available if they are normally offered on Alcove and not listed as an exception.

- ☒ Composite veneer
- ▶ See *Rapid5 Surface Materials*, page 42.

## Collaboration

Wood Seating



- Designed for comfort and aesthetic appeal
- Self-contained seating program: one frame, field-replaceable arm inserts for customizing opportunities, or available with open arms
- Arm inserts available in matching or contrasting finishes to the frame

### Available Products

Style Number	Description
<b>120</b>	Guest chair with open wood arms
<b>120L</b>	Guest chair with wood arms and ladder insert

### Surface Materials

All Rapid5 surface materials are available if they are normally offered on Collaboration and are not listed as an exception.

- ☒ Composite veneer
- ▶ See *Rapid5 Surface Materials*, page 42.

## Deck

Wood Seating



- Designed by Brian Kane
- Stackable five high for easy storage
- Ganging feature to link chairs for evenly spaced rows

### Available Products

Style Number	Description
<b>DECKC14</b>	Guest chair, wood arms, back and seat
<b>DECKC14G</b>	Guest chair, wood arms, back and seat, with ganging device
<b>DECKC24</b>	Guest chair, wood arms, wood back, and upholstered seat
<b>DECKC24G</b>	Guest chair, wood arms, back and seat, with ganging device
<b>DECKC34</b>	Guest chair, wood arms, upholstered back and seat
<b>DECKC34G</b>	Guest chair, wood arms, upholstered back and seat, with ganging device
<b>DECKC35</b>	Guest chair, urethane arms, upholstered back and seat
<b>DECKC35G</b>	Guest chair, urethane arms, upholstered back and seat, with ganging device
<b>DECKS1</b>	Stool with wood back and seat
<b>DECKS2</b>	Stool with wood back and upholstered seat
<b>DECKS3</b>	Stool with upholstered back and seat

### Surface Materials

All Rapid5 surface materials are available if they are normally offered on Deck and are not listed as an exception.

- ☒ Composite veneer
- ▶ See *Rapid5 Surface Materials*, page 42.

## England

Wood Seating

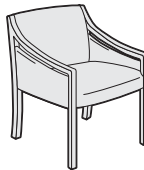

- Designed by Burt England
- Back and seat are fully upholstered
- Arm may be enclosed with upholstery or left open

### Available Products

Style Number	Description
<b>0113</b>	Enclosed arms
<b>0114</b>	Open arms

### Surface Materials

All Rapid5 surface materials are available if they are normally offered on England and are not listed as an exception.

- ☒ Composite veneer
- ▶ See *Rapid5 Surface Materials*, page 42.

## Wood Seating, Rapid5, continued

### Escapade

Wood Seating



- Elegant contemporary guest chair
- Upholstered seat with slatted wood back
- Graceful curved arms for comfort and aesthetics

#### Available Products

All Escapade seating products and options in the current electronic specification guide are available.

#### Surface Materials

All Steelcase Rapid5 surface materials are available if they are normally offered on Escapade seating and not listed as an exception.

Composite veneer

▶ See *Steelcase Rapid5 Surface Materials*, page 42.

### Mingle

Wood Seating



- Contemporary guest seating combines the warmth of wood and the strength of steel
- Simple scale and tailored appearance
- Designed with integrated lumbar appearance

#### Available Products

Style Number	Description
--------------	-------------

MNGLB	Wood guest chair, with arms, upholstered seat, black legs
-------	---

#### Surface Materials

All Rapid5 surface materials are available if they are normally offered on Mingle and are not listed as an exception.

Composite veneer

▶ See *Rapid5 Surface Materials*, page 42.

### Oriana

Wood Seating



- Classic look enhances any contemporary or transitional interior.
- An elegant and refined interpretation of early ladder and slat back armchairs.
- Versatile solution for use in conference rooms and with a wide variety of casegoods.

#### Available Products

Style Number	Description
--------------	-------------

0202	Wood guest chair with vertical slat back
0204	Wood guest chair with horizontal slat back
0205	Wood guest chair with fully upholstered back

#### Surface Materials

All Rapid5 surface materials are available if they are normally offered on Oriana and are not listed as an exception.

Composite veneer

▶ See *Rapid5 Surface Materials*, page 42.

### Terrazzo

Wood Seating



- Simple lines and classic lattice back styling.
- Features a choice of back inset designs that allow it to fit comfortably in any corporate environment.
- Arms rise gently to help you in and out.
- The back is bowed to provide additional support and comfort when you are seated.

#### Available Products

Style Number	Description
--------------	-------------

TERR1	Wood guest chair with square lattice back
TERR2	Wood guest chair with Macintosh lattice back
TERR3	Wood guest chair with horizontal lattice back

#### Surface Materials

All Rapid5 surface materials are available if they are normally offered on Terrazzo and are not listed as an exception.

Composite veneer

▶ See *Rapid5 Surface Materials*, page 42.

### Topaz

Wood Seating



- Transitional/traditional side chair
- Features an open back, carved leg detail, and clean rectilinear lines
- Appropriate for guest, reception, and dining applications

#### Available Products

**G24** Wood guest chair with open back  
**G26** Wood guest chair with closed back

#### Surface Materials

All Rapid5 surface materials are available if they are normally offered on Topaz and are not listed as an exception.

Composite veneer

▶ See *Rapid5 Surface Materials*, page 42.

### Sawyer

Wood Seating



- Upholstered seat
- Webbed panel construction seat for added comfort
- Frame: wood (European beech)
- Back with horizontal slats

#### Available Products

Style Number	Description
--------------	-------------

TS37602	Wood guest chair, fully assembled
---------	-----------------------------------

#### Surface Materials

All Rapid5 surface materials are available if they are normally offered on Sawyer and not listed as an exception.

Fire Code

Leather

▶ See *Rapid5 Surface Materials*, page 42.

## Snodgrass 474 Series

Wood Seating



- Designed by Warren Snodgrass
- Offers guest and occasional seating of classic simplicity
- An enduring design that is always in style

### Available Products

Style Number	Description
474419W	Open loop arms with open back - wood

### Surface Materials

All Rapid5 surface materials are available if they are normally offered on Snodgrass.

 Composite veneer

▶ See *Rapid5 Surface Materials*, page 42.

# Details, Rapid5

## Series 3 Height-Adjustable Worksurfaces

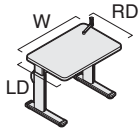

- Seated height-adjustability
- Height range from 22" to 34"
- 220 lbs. weight capacity (including weight of worksurface)
- Front crank handle

### Available Products

Style Number	Description
<b>A3RQ462929U</b>	Series 3 - Rectangular, Universal Tables, 29x46, excluding 1" adjustable glide
<b>A3RQ582929U</b>	Series 3 - Rectangular, Universal Tables, 29x58, excluding 1" adjustable glide
<b>A3RQ702929U</b>	Series 3 - Rectangular, Universal Tables, 29x70, excluding 1" adjustable glide

### Surface Materials

#### Base Paint

- 0835 Black
- 4799 Platinum Metallic

All Rapid5 surface materials are available if they are normally offered on Series 3 and not listed as an exception.

- ☒ Wood veneer
- ☒ Full-Fill finishes

▶ See *Rapid5 Surface Materials*, page 42.

## Series 5 Details Height-Adjustable Worksurfaces

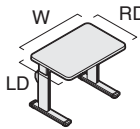

- Electric sit-to-stand height-adjustability
- Height range from 25 1/2" to 52"
- 220 lbs. weight capacity (including weight of worksurface)
- Up/down controller

### Available Products

Style Number	Description
<b>A5RQ462929U</b>	Series 5 - Rectangular, Universal Tables, 29x46, excluding 1" adjustable glide
<b>A5RQ582929U</b>	Series 5 - Rectangular, Universal Tables, 29x58, excluding 1" adjustable glide
<b>A5RQ702929U</b>	Series 5 - Rectangular, Universal Tables, 29x70, excluding 1" adjustable glide

### Surface Materials

#### Base Paint

- 0835 Black
- 4799 Platinum Metallic

All Rapid5 surface materials are available if they are normally offered on Series 5 and not listed as an exception.

- ☒ Wood veneer
- ☒ Full-Fill finishes

▶ See *Rapid5 Surface Materials*, page 42.

## Series 7 Details Height-Adjustable Worksurfaces

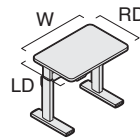

- Enhanced electric sit-to-stand height-adjustable
- Height range from 24 1/4" to 52"
- 360 lbs. weight capacity (including weight of worksurface)

### Available Products

Style Number	Description
<b>A7RQ462929U</b>	Series 7 - Rectangular, Universal Tables, 29x46, excluding digital and activation button controller options
<b>A7RQ582929U</b>	Series 7 - Rectangular, Universal Tables, 29x58, excluding digital and activation button controller options
<b>A7RQ702929U</b>	Series 7 - Rectangular, Universal Tables, 29x70, excluding digital and activation button controller options

### Surface Materials

#### Base Paint

- 0835 Black
- 4799 Platinum Metallic

All Rapid5 surface materials are available if they are normally offered on Series 7 and not listed as an exception.

- ☒ Wood veneer
- ☒ Full-Fill finishes

▶ See *Rapid5 Surface Materials*, page 42.

## Airtouch Height-Adjustable Worksurfaces

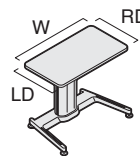

- Collaborative sit-to-stand height-adjustable
- Height range from 26" to 43"
- 150 lbs. weight capacity (including weight of worksurface)
- Lift paddle

### Available Products

Style Number	Description
<b>BAPSS3048</b>	Airtouch - Rectangular, Universal Tables shape, 28 1/4"D x 46"W, laminate plastic 3 mm edge
<b>BAPSS3060</b>	Airtouch - Rectangular, Universal Tables shape, 28 1/4"D x 58"W, laminate plastic 3 mm edge

### Surface Materials

#### Base Paint

- 4799 Platinum Metallic

All Rapid5 surface materials are available if they are normally offered on AirTouch and not listed as an exception.

- ☒ Wood veneer
- ☒ Full-Fill finishes

▶ See *Rapid5 Surface Materials*, page 42.



## Details

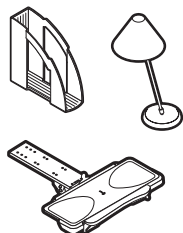

- Ergonomic solutions that help people interact with computers
- Help organize flow of work
- Cost-effective and personalized lighting solutions

### Available Products

#### Computer Support Tools

- All mechanisms
- All platforms
- All CPU supports
- All flat panel monitor arms, except FYI dual arm with c:scape rail bracket.

#### Organizational Worktools

- Slatwall and SlatRail
- SOTO rail
- All components that mount to Slatwall, SlatRail, SOTO rails, and Personal Pocket
- Laptop support and freestanding solutions

#### Task Lighting

- All personal task lighting, except Dash
- Power Pincher

#### Privacy



- Privacy screen

### Surface Materials

▶ See *Rapid5 Surface Materials for Details*, page 42.  
 Note: Not all surface materials are available on all Details products. Consult the *Details Specification Guide* for individual product specifications for color availability.

# Rapid5 Surface Materials

The surface materials listed below are available on the Rapid5 program if:

- they are offered on the product you are ordering, and
  - they are not listed as exception in that product's section within the Rapid5 section of this handbook or in the Surface Materials Exceptions list
-  Wood on steel products  
 Custom surface materials program, such as, Open Line Laminate, Customer's Own Material/Vinyl, Customiz Stain, PerfectMatch Paint, full-fill finishes, premium veneers, composite veneers, Select Surfaces, Textiles Cut Yardage, etc.
- ▶ See the *Surface Materials Reference Manual* for more details.

## Paint Steelcase Surfaces

### Smooth Paint

Paint Price Group 1  
4242 Milk

### Textured Paint

Paint Price Group 1  
7207 Black  
7225 Sand  
7230 Basalt  
7238 Fieldstone  
7239 Midnight  
7241 Arctic White  
7238 Fieldstone  
7250 Dark Solid  
7360 Merle

### Smooth Metallic Paint

Paint Price Group 2  
4728 Nickel Metallic  
4743 Mineral Metallic  
4744 Pearl Metallic  
4750 Champagne Metallic  
4798 Sterling Metallic  
4799 Platinum Metallic  
4803 Near Black Metallic

### Textured Metallic Paint

Paint Price Group 2  
7245 Carbon Metallic  
7246 Midnight Metallic

### Coating

4710 Low Gloss Black

## High-Pressure Laminate (HPL) Steelcase Surfaces

### Fiber Laminate

2850 Vanadium Fiber  
2851 Rhyme Fiber  
2852 Tungsten Fiber  
2854 Vellum Fiber  
2859 Novell Fiber  
2860 Granite Fiber  
2861 Coconut Fiber  
2862 Stucco Fiber

## Low-Pressure Laminate (LPL)

2LAK Clear Oak LPL  
2LAT Acacia LPL  
2L03 Brushed Silver LPL  
2L09 Clear Maple LPL  
2L30 Arctic White LPL  
2L50 Vanadium Fiber LPL  
2L52 Tungsten Fiber LPL  
2L83 Seagull LPL  
2L85 Dune LPL  
24L0 Graphite Walnut LPL  
25L1 Winter on Maple LPL  
25L5 Virginia Walnut LPL  
25L6 Blackwood LPL  
25L8 Clear Walnut LPL  
26L1 Natural Cherry Version 2 LPL  
247L Black Version 2 LPL  
262L Marbled Maple LPL  
264L Chocolate Walnut LPL  
267L Marbled Cherry Version 2 LPL

## Metallic Laminate

2L03 Brushed Silver LPL  
2503 Brushed Silver

## Micro Laminate

2920 Marl Micro  
2921 Gypsum Micro  
2922 Clay Micro  
2923 Shadow Micro

## Patina Laminate

2870 Blonde Bronze Patina  
2871 Blackened Bronze Patina  
2873 Instant Iron Patina

## Solid Laminate

2730 Arctic White  
2746 Black  
2883 Seagull  
2884 Milk  
2885 Dune

## Speckle Laminate

2820 Coffee Speckle  
2822 Woodrose Speckle  
2823 Driftwood Speckle  
2824 Smoke Speckle  
2825 Vanadium Speckle

## Woodgrain Laminate

2406 Clear Cherry  
2409 Clear Maple  
2410 Graphite Walnut  
2412 Natural Cherry  
2422 Medium Cherry  
2511 Winter on Maple  
2538 Clear Walnut  
2592 Blonde on Maple  
2714 Natural Walnut  
2HAK Clear Oak  
2HAT Acacia

## Turnstone Laminate Collection

2535 Virginia Walnut  
2536 Blackwood  
2612 Marbled Maple  
2614 Chocolate Walnut  
2615 Marbled Cherry

## Systems Plastic and Edge Band

6000 Black  
6001 Coffee  
6034 Natural Cherry  
6036 Medium Cherry  
6037 Winter on Maple  
6038 Blonde on Maple  
6041 Natural Walnut  
6052 Milk  
6053 Seagull  
6055 Carbon Metallic  
6056 Midnight Metallic  
6094 Mineral Metallic  
6219 Clear Oak  
6231 Graphite Walnut  
6234 Clear Cherry  
6237 Clear Maple  
6242 Virginia Walnut  
6243 Blackwood  
6245 Clear Walnut  
6249 Platinum Solid  
6615 Grey V5  
6623 Metallic  
6631 Cream  
6636 Mist  
6654 Sand  
6655 Warm White  
6676 Marbled Maple  
6677 Chocolate Walnut  
6678 Marbled Cherry  
6681 Grotto  
6682 Cobblestone  
6694 Slate  
6695 Midnight  
6697 Fog  
6698 Fieldstone

## Plated Metal

9210 Copper  
9211 Nickel  
9212 Silver

## Metal

9230 Antique Bronze  
9201 Polished Chrome  
9250 Ember Chrome

## Seating Plastic

6009 Arctic White  
6205 Black  
6206 Burgundy  
6250 Coffee  
6256 Graphite  
6259 Midnight  
6268 Navy  
6295 Near Black  
6296 Sterling  
6301 Aegean  
6302 Baltic  
6303 Pomegranate  
6333 Picasso  
6335 Wasabi  
6336 Jazz

## Seating Coating

7000 Black  
7005 Coffee  
7011 Graphite

## Glass

6500 Clear  
6518 Opaque

## Markerboard Trim

7451 Black

**Wood Veneer****Flat-cut open-pore finish choices**

- 3062 Graphite Walnut
- 3402 Clear Cherry (Aged)
- 3422 Medium Cherry
- 3522 Clear Maple\*
- 3592 Blonde on Maple
- 3702 Clear Walnut
- 3712 Natural Walnut
- 3722 Dark Mahogany on Walnut

- 3752 Medium Walnut
- 3762 Dark Walnut
- 3772 Medium Mahogany on Walnut

*\*Because no stain is used in the clear-coat process, a sign-off will be required prior to orders being accepted for this finish. The sign-off sheet is available through Steelcase advertising stock. Form number 05-0001370*

**Quarter-cut open-pore finish choices**

- 3042 Ash
- 3222 Clear Maple\*
- 3292 Blonde on Maple
- 3302 Clear Walnut
- 3312 Natural Walnut
- 3322 Dark Mahogany on Walnut
- 3352 Medium Walnut
- 3362 Dark Walnut
- 3372 Medium Mahogany on Walnut
- 3382 Graphite Walnut

*\*Because no stain is used in the clear-coat process, a sign-off will be required prior to orders being accepted for this finish. The sign-off sheet is available through Steelcase advertising stock. Form number 05-0001370*

**Rift-cut open-pore finish choices**

- 3602 Desert Oak
- 3692 Espresso Oak

**Seating Wood**

- 3422 Medium Cherry
- 3522 Clear Maple
- 3572 Amber Maple
- 3592 Blonde Maple
- 3642 Natural Oak
- 3712 Natural Walnut
- 3722 Dark Mahogany on Walnut
- 3762 Dark Walnut
- 3772 Medium Mahogany on Walnut

**Vertical Surface  
Fabrics  
Steelcase Surfaces****Alloy***Price Group 1*

- P525 Polar
- P526 Skim
- P527 Bubbly
- P528 Tern
- P529 Shore
- P530 Asti
- P531 Silver
- P532 Oxide
- P533 Element
- P534 Construct
- P535 Currency
- P536 Iron

**Bariolage***Price Group 1*

- G200 New Etude
- G201 New Andante
- G202 New Cantata
- G203 New Adagio
- G204 New Melody
- G205 New Ballata
- G206 New Sonata

**Boccie***Price Group 1*

- P200 New Rice
- P201 New Almond
- P202 New Nutmeg
- P203 New Camel
- P204 New Opal
- P205 New Mist
- P206 New Plum
- P207 New Lichen
- P208 New Spearmint
- P209 New Sky

**Buzz2***Price Group 1*

- 5F03 Tomato
- 5F05 Burgundy
- 5F07 Blue
- 5F08 Navy
- 5F15 Stone
- 5F16 Grey
- 5F17 Black
- 5G50 Dunegrass
- 5G51 Sable
- 5G52 Barley
- 5G53 Sunrise
- 5G54 Carrot
- 5G55 Pumpkin
- 5G56 Timber
- 5G57 Rouge
- 5G58 Chocolate
- 5G59 Meadow
- 5G60 Ivy
- 5G61 Cyan
- 5G62 Atlantic
- 5G63 Crocus
- 5G64 Alpine
- 5G65 Tornado

**Charm***Price Group 1*

- P504 Tint
- P505 Shell
- P506 Mimosa
- P507 Birch
- P508 Sparkle
- P509 Ginkgo
- P510 Debut
- P511 Clover
- P512 Spicy
- P513 Twilight

**Cogent: Connect***Price Group 2*

- 5S15 Coconut
- 5S16 Turmeric
- 5S17 Tangerine
- 5S18 Scarlet
- 5S19 Concord
- 5S20 Maya Blue
- 5S21 Blue Jay
- 5S23 Wasabi
- 5S24 Nickel
- 5S25 Graphite
- 5S26 Licorice
- 5S27 Malt
- 5S28 Root Beer
- 5S93 Blueprint
- 5S94 Lizard
- 5S95 Sailor
- 5S96 Quicksilver
- 5S97 Nugget
- 5S98 Canary
- 5S99 Lipstick
- 5SD0 Royal Blue

**Flip: Orbit***Price Group 3*

- 5F85 Mud Pie
- 5F86 Hummus
- 5F87 Petoskey
- 5F88 Pluto
- 5F89 Papyrus
- 5F91 Blizzard
- 5F92 Briquette

**Flip: Plain Jane***Price Group 3*

- 5F70 Mud Pie
- 5F71 Hummus
- 5F72 Petoskey
- 5F73 Pluto
- 5F74 Papyrus
- 5F94 Blizzard
- 5F95 Briquette

**Flip: TexHex***Price Group 3*

- 5F75 Mud Pie
- 5F76 Hummus
- 5F77 Petoskey
- 5F78 Pluto
- 5F79 Papyrus
- 5F97 Blizzard
- 5F98 Briquette

**Fresco***Price Group 2*

- G001 Sandrift
- G002 Mistiblu
- G003 Faon
- G006 Chamoline
- G007 Grapenut
- G017 Flint

**Lapel***Price Group 1*

- P409 Cement
- P410 Pebble
- P411 Beech
- P412 Dune
- P413 Grain
- P414 Sprout
- P415 Misty Blue
- P416 Maple
- P417 Slate

**Lido***Price Group A*

- R159 Oak Bluffs
- R160 Cape May
- R162 Hermosa

**Optic**

- Price Group 1*  
 P540 Hazel  
 P541 Twinkle  
 P542 Orion  
 P543 Seaglass  
 P544 Shine  
 P545 Halo  
 P546 Whiskey  
 P547 Bath  
 P548 Whisper  
 P549 Breezy  
 P550 Wry  
 P551 Glimmer

**Pianista**

- Price Group 1*  
 P420 Sand  
 P421 Mist  
 P422 Rain  
 P423 Natural  
 P424 Café  
 P425 Denim  
 P426 Carbon  
 P427 Stone  
 P428 Flax  
 P429 Oat  
 P430 Wheat  
 P431 Maize

**Rhythm**

- Price Group 1*  
 P555 Allegro  
 P556 Tempo  
 P557 Refrain  
 P558 Pitch  
 P559 Harmony  
 P560 Melody  
 P561 Stanza  
 P562 Opus

**Sprite**

- Price Group 1*  
 5540 Khaki  
 5541 Snow  
 5542 Butter  
 5543 Linen  
 5544 Sherbet  
 5545 Powder  
 5546 Harvest  
 5547 Sky  
 5548 Kiwi

**Tinsel**

- Price Group 1*  
 P515 Sugar  
 P516 Lit  
 P517 Ego  
 P518 Fizz  
 P519 Muse  
 P520 Depth  
 P521 Bliss  
 P522 Grow  
 P523 Dolce  
 P524 Boost

**Seating Upholstery  
 Steelcase Surfaces**

**Bo Peep**

- Price Group 5*  
 5G66 Pita  
 5G67 Bone  
 5G68 Safari  
 5G69 Brown Sugar  
 5G70 Chocolate Chip  
 5G71 Candlelight  
 5G72 Honey Mustard  
 5G73 Marmalade  
 5G74 Picnic  
 5G75 Pinot  
 5G76 Bloom  
 5G77 Grapevine  
 5G78 Firefly  
 5G79 Artichoke  
 5G80 Serpent  
 5G81 Carolina  
 5G82 Blue Bonnet  
 5G83 Nautical  
 5G84 Gravel  
 5G85 Sharkskin  
 5G86 Kohl

**Brisa**

- Price Group 6*  
 BR01 Black Onyx  
 BR04 Truffle  
 BR07 Sage  
 BR10 Night Navy  
 BR18 New Sand

**Buzz2**

- Price Group 1*  
 5F03 Tomato  
 5F05 Burgundy  
 5F07 Blue  
 5F08 Navy  
 5F15 Stone  
 5F16 Grey  
 5F17 Black  
 5G50 Dunegrass  
 5G51 Sable  
 5G52 Barley  
 5G53 Sunrise  
 5G54 Carrot  
 5G55 Pumpkin  
 5G56 Timber  
 5G57 Rouge  
 5G58 Chocolate  
 5G59 Meadow  
 5G60 Ivy  
 5G61 Cyan  
 5G62 Atlantic  
 5G63 Crocus  
 5G64 Alpine  
 5G65 Tornado

**Chainmail**

- 5550 Cotton  
 5551 Space  
 5552 Silver Dollar  
 5553 Volcano  
 5554 Orange Crush  
 5555 Tricycle  
 5556 Geranium  
 5557 Banana  
 5558 Margarita  
 5559 Lagoon

**Cogent: Connect**

- Price Group 2*  
 5S15 Coconut  
 5S16 Turmeric  
 5S17 Tangerine  
 5S18 Scarlet  
 5S19 Concord  
 5S20 Maya Blue  
 5S21 Blue Jay  
 5S23 Wasabi  
 5S24 Nickel  
 5S25 Graphite  
 5S26 Licorice  
 5S27 Malt  
 5S28 Root Beer  
 5S93 Blueprint  
 5S94 Lizard  
 5S95 Sailor  
 5S96 Quicksilver  
 5S97 Nugget  
 5S98 Canary  
 5S99 Lipstick

**Cogent: Trails**

- Price Group 2*  
 5S29 Bronzite  
 5S30 Amethyst  
 5S84 Jasper  
 5S85 Agate  
 5S86 Lapis  
 5S87 Malachite  
 5S89 Carnelian  
 5S90 Tiger Eye  
 5S91 Travertine  
 5S92 Topaz

**Crosswalk**

- Price Group 2*  
 5F48 Beech  
 5F49 Moon  
 5F50 Berry  
 5F51 Admiral Blue  
 5F52 Moss  
 5F53 Persimmon  
 5F54 Bittersweet  
 5F55 Midnight  
 5F56 Poppy

**Gaja – C2C**

- Price Group 3*  
 5W40 Black  
 5W41 Pepper  
 5W42 Pearl Grey  
 5W43 Crimson  
 5W44 Ink  
 5W45 Night Blue  
 5W46 Petrol  
 5W47 Greige  
 5W48 Sepia  
 5W49 Umber  
 5W50 Java  
 5W51 Camellia Red  
 5W52 Emerald  
 5W53 Snow Pea  
 5W54 Olive  
 5W55 Light Blue  
 5W56 Maroon  
 5W57 Black Raspberry  
 5W58 Spruce  
 5W59 Apple Green  
 5W60 Deep Blue  
 5W61 Chili Pepper  
 5W62 Daffodil

**Jacks**

- Price Group 1*  
 5B61 Taupe  
 5B63 Camel  
 5B64 Pewter  
 5B66 Plum  
 5B70 Midnight

**Link**

- Price Group 1*  
 5A20 Burgundy  
 5A23 Green  
 5A24 Blue  
 5A25 Navy  
 5A26 Purple  
 5A27 Black  
 5A28 Ocean  
 5A30 Chamois

**Nitelights**

- Price Group 2*  
 5F58 Hazelnut  
 5F59 Burgundy  
 5F60 Cherry  
 5F61 Earth  
 5F62 Shore  
 5F63 Moss  
 5F64 Sea  
 5F65 Regal Blue  
 5F66 Stone  
 5F67 Moon

**Playground***Price Group 1*

5F28 Claret  
 5F29 Chile  
 5F30 Amber  
 5F31 Nut  
 5F32 Blade  
 5F33 Stone  
 5F34 Sky  
 5F35 Navy  
 5F36 Huckleberry  
 5F37 Charcoal

**Zoe2***Price Group 2*

5C90 Eggplant  
 5C91 Aloe  
 5C92 Fiddle  
 5C93 Patina  
 5C94 Peacock  
 5C95 Rain  
 5C96 Gray Flannel  
 5C97 Pebble  
 5C98 Cymbal  
 5C99 Fiesta

**Leather***Price Group Leather*

L107 Black  
 L500 Camel  
 L503 Navy

**Stand In***Price Group 2*

5621 Sleet  
 5622 Lunar  
 5623 Cyclone  
 5624 Eclipse  
 5625 Powder  
 5626 Chardonnay  
 5627 Graham  
 5628 Sediment  
 5629 Allspice  
 5630 Apple  
 5631 Lava  
 5632 Cayenne  
 5633 Plantain  
 5634 Parley  
 5635 Scallion  
 5636 Atlantis  
 5691 Orca

**Turnstone Collection  
by Designtex****Boyne - 3280***Price Group 3*

T925 Sand  
 T926 Bark  
 T927 Bittersweet  
 T928 Brick  
 T929 Navy  
 T930 Peridot  
 T931 Plum  
 T932 Comet  
 T933 Boulder

**Glen Arbor - 3283***Price Group 4*

T945 Sand  
 T946 Bark  
 T947 Iris  
 T948 Green Stone  
 T949 Plum  
 T950 Comet  
 T951 Boulder

**Great Lakes - 3282***Price Group 3*

T935 Sand  
 T936 Bark  
 T937 Iris  
 T938 Green Stone  
 T939 Peridot  
 T940 Mountain  
 T941 Comet

**Leland - 3281***Price Group 4*

T955 Birch  
 T956 Sand  
 T957 Frost  
 T958 Comet  
 T959 Bark  
 T960 Apple  
 T961 Wild Flower  
 T962 Plum  
 T963 Lake  
 T964 Peridot

**Ludington - 3285***Price Group 3*

T965 Putty  
 T966 Dune  
 T967 Walnut  
 T968 Cloud  
 T969 Chocolate  
 T970 Red Clay  
 T972 Earth  
 T973 Cobblestone  
 T974 Fog  
 T975 Midnight  
 T976 Wood Smoke  
 T977 Gray

**Saugatuck - 3284***Price Group 4*

T915 White Pine  
 T916 Bark  
 T917 Sand  
 T918 Apple  
 T919 Navy  
 T920 Green Stone  
 T921 Comet  
 T922 Boulder  
 T923 Plum

**Other Upholstery****3D Knit**

5064 Licorice  
 5065 Coconut  
 5066 Malt  
 5067 Root Beer  
 5092 Graphite

**3D Connect**

5014 Royal Blue  
 5015 Coconut  
 5016 Turmeric  
 5017 Tangerine  
 5018 Scarlet  
 5019 Concord  
 5020 Maya Blue  
 5021 Blue Jay  
 5023 Wasabi  
 5024 Nickel  
 5025 Graphite  
 5026 Licorice  
 5027 Malt  
 5028 Root Beer  
 5030 Sailor

**Jersey Mesh**

T084 Licorice  
 T085 Grey  
 T086 White  
 T087 Yellow  
 T088 Orange  
 T089 Red  
 T090 Green  
 T091 Blue  
 T094 Cardinal

**Reply Mesh**

AR01 Grey  
 AR02 Black  
 AR04 Red  
 AR06 Apple Green  
 AR09 Sable

**Details  
Surface Materials****Paint**

0835 Black  
 4231 Arctic White  
 4710 Low Gloss Black  
 4750 Champagne  
 4799 Platinum  
 7018 Pewter  
 7021 Dark Champagne  
 7027 Charcoal  
 7055 Metallic Red

**Plastic**

6000 Black  
 6009 Arctic White  
 6059 Sterling Dark Solid  
 6152 Champagne  
 6153 Pewter  
 6288 Charcoal  
 6544 Frost  
 6545 Amber  
 6546 Rain

**Acrylic**

6544A Frost



# Rapid10 Coalesse

December 15, 2014

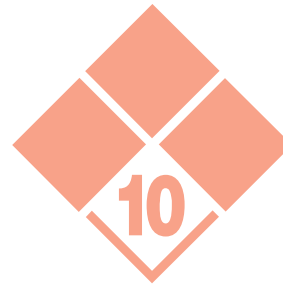

Featuring Coalesse products manufactured and shipped in 10 business days.

- U.S. electronic price list support:  
December 15, 2014 (180.E)

## Contents

Program Overview	48
How to Order	48
Order Maximums	48
Rapid10 Coalesse Planner	48
Rapid10 Coalesse Thought Starters	49

## Product Offering

Coalesse Seating	51
Coalesse Occasional Tables	55
Coalesse Multipurpose and Conferencing Tables	56
Rapid10 Surface Materials	58

### Questions?

Call Steelcase at 1.888.STEELCASE or send an email to [lineone@steelcase.com](mailto:lineone@steelcase.com) (Outside the U.S.A., Canada, Mexico, Puerto Rico, and the U.S. Virgin Islands, call 616.247.2500).

# Rapid10 Coalesse

## Program Overview

- The Coalesse Rapid10 program is exclusive to Coalesse and provides a broad selection of our most popular seating, occasional tables, and multipurpose and conferencing tables with expedited shipping.
- All products are made-to-order and ship in 10 business days and typically deliver within 15 business days.
- Coalesse Rapid10 is designed for clients whose needs require fast delivery of products with professional-grade performance and versatility that can be applied in a home workplace as elegantly as any professional office environment. The comprehensive Coalesse offering in this program can easily provide a range of solutions for any setting.

### Products Included in Rapid10:

#### Seating

- Astor Lounge
- Await Lounge
- Bix Lounge
- Circa Lounge
- Coupe Lounge
- Enea
- Kart
- Swathmore
- X-Stack

#### Occasional Tables

- Await Tables
- Bix Tables
- Enea Tables

#### Indoor/Outdoor

- Emu Advanced Outdoor Collection

#### Multipurpose and Conferencing Tables

- Akira
- E-Tables2
- Runner

### Surface Materials Included in Rapid10:

- A full offering of surface materials are available on Rapid10.
  - To determine if an upholstery is approved for a product, consult the Coalesse fabric database.
- ▶ See *Rapid10 Surface Materials*, page 58.

## How to Order

- Orders must be specified and transmitted using the CLQ electronic catalog to ensure orders are processed quickly.
- Use electronic catalog code: CLQ Coalesse Rapid10.
  - Orders cannot be changed or cancelled.
  - The Coalesse Rapid10 program is limited to the models, fabrics, and finishes listed in the CLQ electronic catalog.
  - Consult the Coalesse specification guides for product details.

## Order Maximums

Product Category	Maximum Quantity Per Style Number
Seating	5 pieces
Occasional Tables	5 pieces
Multipurpose and Conferencing Tables	5 pieces

Order maximums are calculated by product category. For projects greater than the order maximums, use the standard electronic catalog and contact Coalesse Customer Service Team at 800.627.6770 for a delivery schedule. Splitting large orders into smaller orders to get the Coalesse Rapid10 lead time is not allowed. In the event an order is received that exceeds the maximum style number quantity, the entire order will be moved to standard lead time. If demand exceeds capacity, then orders are subject to availability.

## Rapid10 Planner

### Manufacturing, Shipping, and Delivery Time

Rapid10 orders are manufactured and shipped in 10 business days.

Example:

Day 0	Day 1-9	Day 10	Day 15
Coalesse receives complete and clean order before 5:00pm EST.	Order management, materials procurement, order is manufactured.	Order is shipped from manufacturing facility and in transit.	Order is delivered.

Coalesse Rapid10 orders are manufactured in 10 business days and typically deliver within 15 business days (weekends, national holidays, or Coalesse holidays are not included). Orders will ship through the Coalesse distribution network. Product mix, dealer profiles, and warehouse scheduled delivery days may impact the actual delivery date. Contact Coalesse Customer Service Team for expedited delivery options. Additional charges may apply.



# Rapid10 Coalesse Thought Starters

Rapid10 Coalesse  
Thought Starters

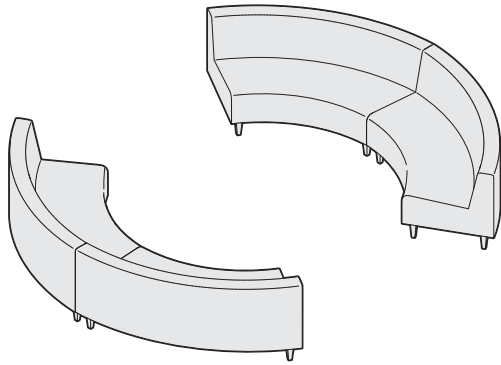

(4) Circa 60 degree inside wedge loveseats (451-7460F1)

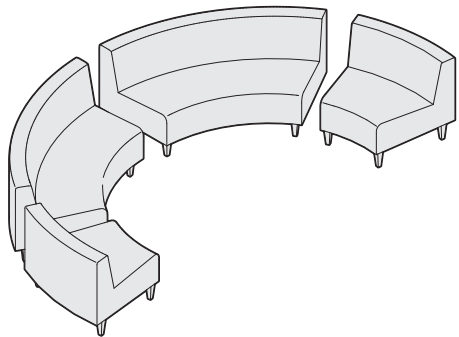

(2) Circa 60 degree inside wedge loveseats (451-7460F1) with (2) Circa 30 degree wedge seats (451-3730F1)



(3) Enea bar stools (3513S) around Enea bar height table (H35-T3642L)

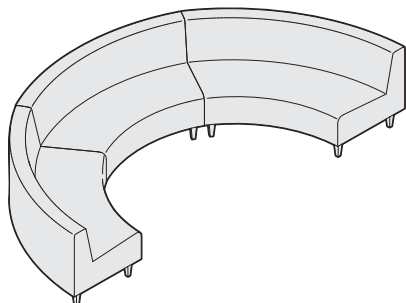

(3) Circa 60 degree inside wedge loveseats (451-7460F1)

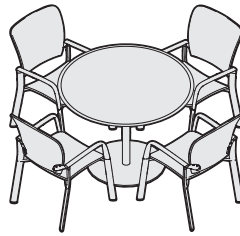

(4) Enea stacker chairs (3503) around Enea conference table with laminate surface (H35-T4230L)

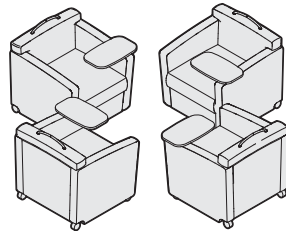

(4) Swathmore Grande seats with right facing tablet (243MTR)

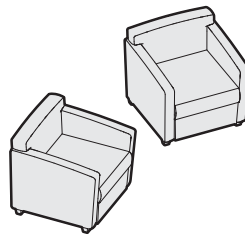

(2) Swathmore Grande seats (243)

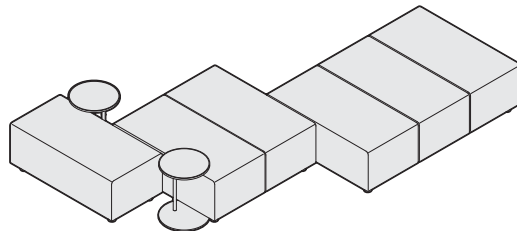

(1) Await one section bench (461-1B), (1) Await two section bench (461-2B), (1) Await three section bench (461-3B), (2) Await freestanding low tables (46-T1)

## Rapid10 Coalesse Thought Starters, continued

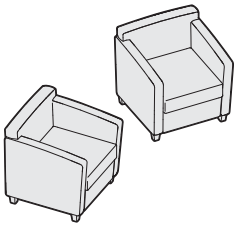

(2) Swathmore lounge (240)

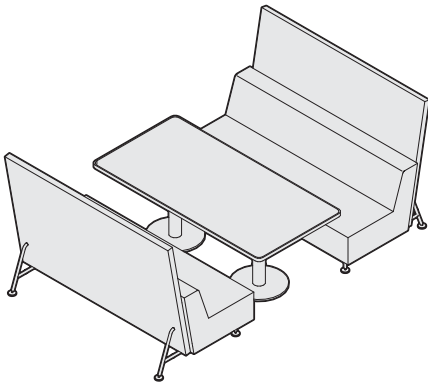

(2) Bix straight section 72" with backs (BSSB72XX), (1) Bix rectangular work booth table 72" (BTW36723)



(4) Kart nesting chairs with upholstered seat (126201S), (4) Akira T-base tables (AKF4830RTC)

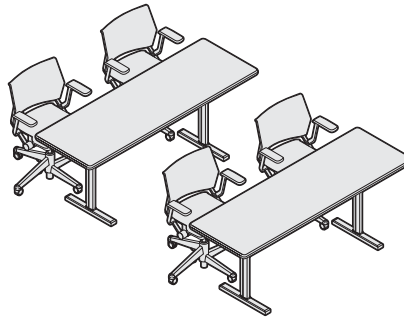

(2) Runner table (464950), (4) Kart nesting chairs with upholstered seat (126201S)

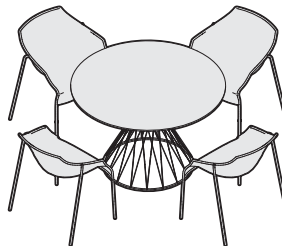

(1) Emu Heaven table frame (CO2494QS), (1) Emu Heaven table surface (CO2494VQS), (2 sets of 2 armchairs = 4) Emu Heaven armchairs (CO2486QS)

## Astor

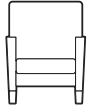

- One-, two-, and three-seat models
- Transitional styling with excellent comfort
- Loose cushions with optional attachment straps
- Contrasting textiles add design flexibility
- Solid maple legs

### Available Products

**318** Chair

### Surface Materials

#### Upholstery

- ▶ See *Coalesse Rapid10 Surface Materials*, page 58.

#### Finishes

- Coalesse Rapid10 wood finishes are available.
- ▶ See *Coalesse Rapid10 Surface Materials*, page 58.

## Await Lounge

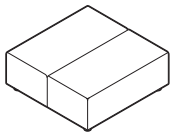

### Await Lounge

- One, two, and three section models
- Extreme comfort, high durability lounge
- Suitable for many applications
- Coordinating table available

### Available Products

**461-1B** One-section connector bench  
**461-2B** Two-section connector bench  
**461-3B** Three-section connector bench

### Surface Materials

All Coalesse Rapid10 seating upholstery is available.

- ▶ See *Coalesse Rapid10 Surface Materials*, page 58.

## Bix Lounge

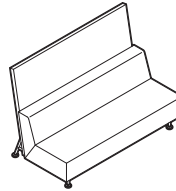

### Bix

- Lounge based worksetting to host teams in comfort
- Designed to create the “booth certified setting” within a space
- SCS Indoor Advantage Gold Certified
- Coordinating tables available

### Available Products

**BSSB48XX** 48”W straight section with back screen  
**BSSB72XX** 72”W straight section with back screen

### Surface Materials

#### Upholstery

- Link
- ▶ See *Coalesse Rapid10 Surface Materials*, page 58.

#### Powder Coat

4142 Platinum Gloss

## Circa Lounge

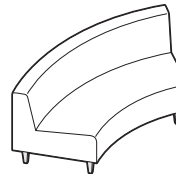

### Circa Lounge

- Modular lounge seating offers alternative to conventional lounge
- High quality. Strong attention to details in stitching and upholstery
- Inside facing seats to create a circular meeting space
- Wood and metal leg options

### Available Products

**451-3730FI** 30° Inside wedge loveseat  
**451-7460FI** 60° Inside wedge loveseat

### Surface Materials

All Coalesse Rapid10 seating upholstery is available.

- ▶ See *Coalesse Rapid10 Surface Materials*, page 58.

#### Wood Legs

All Coalesse Rapid10 wood finishes are available.

- ▶ See *Coalesse Rapid10 Surface Materials*, page 58.

#### Metal Legs

4142 Platinum Gloss

## Coupe Lounge

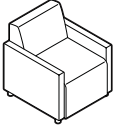

### Coupe Lounge

- Clean design, high comfort
- Two sizes of lounge chairs available

### Available Products

- 470** Chair
- 476** Grande chair

### Surface Materials

#### Seating Upholstery

All Coalesse Rapid10 seating upholstery is available.

- ▶ See *Coalesse Rapid10 Surface Materials*, page 58.

#### Wood Legs

All Coalesse Rapid10 wood finishes are available.

- ▶ See *Coalesse Rapid10 Surface Materials*, page 58.

## Enea

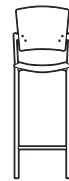

- Top selling guest/side product line
- Competitively priced. Versatile and durable.
- Chairs stack 9 high
- Simple. Uncluttered. Contemporary design.
- Coordinating tables available

### Available Products

#### Stacker

- 3501** Stacker, with arms, with upholstered seat and back
- 3501S** Stacker, armless, with upholstered seat and back
- 3503** Stacker, with arms, with polypropylene seat and back
- 3503S** Stacker armless, with polypropylene seat and back

#### Barstool and Café Stool

- 3513** Barstool, with arms, with polypropylene seat and back
- 3513S** Barstool, armless, with polypropylene seat and back
- H351-SB2719** Café counter stool, upholstered seat and back
- H351-SB3119** Café barstool, upholstered seat and back

### Surface Materials

All Coalesse Rapid10 seating upholstery is available.

- ▶ See *Coalesse Rapid10 Surface Materials*, page 58.

#### Finishes

##### Seat/Back

400 Black polypropylene

##### Frame

Silver metallic

## Kart



### Kart chair

- Ergonomic task seating that folds, nests, and rolls for quick room setup, reconfiguration, or compact storage
- Five nested chairs measure 4'6"

### Kart stool

- Kart chair ergonomic seating in a non-nesting stool-height version on a five-star base with casters

### Kart Stack

- Four-leg stacking chair on glides or casters
- Flexible back frame and armrests move in conjunction to provide continuous support
- Stacks six high on the floor

### Kart Cafe

- Kart Stack flexible back and arm features in a non-stacking stool height version on glides only

## Available Products

### Kart nesting chair with arms

<b>126101</b>	Non-upholstered
<b>126201S</b>	Upholstered seat
<b>126201</b>	Upholstered seat and back

### Kart nesting chair armless

<b>126100</b>	Non-upholstered
<b>126200S</b>	Upholstered seat
<b>126200</b>	Upholstered seat and back

The following accessory is available on Kart nesting chairs:

<b>126900</b>	Leash
---------------	-------

*Tip: Leash retains up to 10 nested chairs for movement. When not in use, the leash stores in a pouch that attaches to the bottom of the seat.*

### Kart stool on casters

<b>126101ST</b>	With arms, non-upholstered
<b>126201SST</b>	With arms, upholstered seat
<b>126201ST</b>	With arms, upholstered seat and back
<b>126100ST</b>	Armless, non-upholstered
<b>126200SST</b>	Armless, upholstered seat
<b>126200ST</b>	Armless, upholstered seat and back

### Kart Stack

<b>126111</b>	Non-upholstered
<b>126211S</b>	Upholstered seat
<b>126211</b>	Upholstered seat and back

The following option is available on Kart Stack:

- Black dual-wheel casters at no additional cost. Add suffix "C" to product number.

### Kart Café

<b>126111ST</b>	Non-upholstered
<b>126211SST</b>	Upholstered seat
<b>126211ST</b>	Upholstered seat and back

## Kart, continued

### Surface Materials

#### Upholstery for seat and back of Kart chair, Kart stool, Kart Stack, and Kart Cafe

All Coalesse Rapid10 seating upholstery is available.

- ▶ See *Coalesse Rapid10 Surface Materials*, page 58.

#### Base for Kart chair and Kart stool and frame for Kart Stack and Kart Cafe

All Coalesse Rapid10 powder coat colors are available.

- ▶ See *Coalesse Rapid10 Surface Materials*, page 58.

#### Injection-molded plastic for Kart chair and Kart stool seat and back

6400 Black  
6427 Grey

#### Injection-molded plastic for Kart Cafe and Kart Stack seat and back

6400 Black

## Swathmore

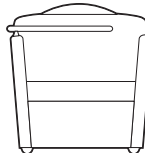

- One, two-, and three-seat versions
- Two scales of top-selling Swathmore lounge seating
- Mobile model available with tablet arm
- Coordinating table

## Available Products

### Wood leg models

<b>240, 243</b>	Chair
<b>240-2</b>	Two-seat sofa
<b>240-3, 243-3</b>	Three-seat sofa

### Mobile models

<b>243MTL</b>	Mobile, left facing tablet, excluding push handle option
<b>243MTR</b>	Mobile, right facing tablet, excluding push handle option

## Surface Materials

### Upholstery

All Coalesse Rapid10 seating upholstery is available.

- ▶ See *Coalesse Rapid10 Surface Materials*, page 58.

### Finishes

All Coalesse Rapid10 wood finishes are available.

- ▶ See *Coalesse Rapid10 Surface Materials*, page 58.

## Emu Advanced Indoor/Outdoor Collection

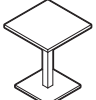
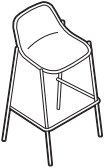

### Emu Advanced Outdoor Collection

- Steel mesh
- Outdoor grade powder coat paint
- SCS Indoor Advantage Gold Certified
- 100% recyclable

### Available Products

- CO2465QS** Emu Round chairs, set of 4
- CO2467QS** Emu Round stools, set of 2
- CO2473QS** Emu Round square table, 31-1/2"W
- CO2485QS** Emu Heaven chair, set of 2
- CO2486QS** Emu Heaven armchair, set of 2
- CO2494QS** Emu Heaven table, 47-1/4" diameter
- CO2494VQS** Emu Heaven table glass top

### Surface Materials

#### Finishes

- 4254 White
- 6547 Transparent glass

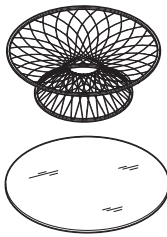

## X-Stack



- Elegant stack chair that provides upholstered comfort without the maintenance of upholstery
- Comfort, durability, user accommodation
- TPU durable material inner shell mixed with a glass filled nylon outer shell
- Optional storage rack

### Available Products

- X1000** Non-upholstered without arms with glides
- X1000C** Non-upholstered without arms with casters

The following options are available on X-Stack:

- Storage rack
- Soft casters

### Surface Materials

#### Finishes

#### Seat/Back

- 6239 Shadow (Dark Grey) thermoplastic polyurethane (TPU)

#### Frame

- 4142 Platinum Gloss

## Await Tables

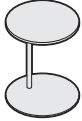

### Await Tables

- Freestanding table to support work anywhere
- Constructed of powder coated turned solid steel tablet rod (post) and base plate with a glass

### Available Products

- 46-T1** Freestanding low round table  
**46-T2** Freestanding high round table

### Surface Materials

#### Top

- 2730 Arctic White  
AC Absolute Glass

## Enea Tables



- Silver metallic frame finish
- Coordinating chairs and barstools available
- Constructed of steel tubing and base with non-skid strip

### Available Products

- H35-T3042L** Café/Bar Height  
**H35-T3642L** Café/Bar Height  
**H35-T4230L** Conference

### Surface Materials

#### Frame

- Silver metallic

#### Top

- 2730 Arctic white  
2746 Black laminate

## Bix Tables

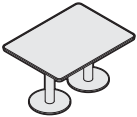

### Bix Tables

- Versatile table that helps to create a lounge based work setting
- Supports conversation and collaboration
- Coordinating lounge pieces available

### Available Products

- BTW36483** 48"W rectangular workbooth table  
**BTW36723** 72"W rectangular workbooth table

### Surface Materials

#### Top

- All Coalesse Rapid10 wood finishes are available.  
▶ See *Coalesse Rapid10 Surface Materials*, page 58.

#### Finishes

##### Base

- 7196 Midnight Brown Texture  
7197 Anthracite Texture

# Coalesse Multipurpose and Conferencing Tables, Rapid10

## Akira Tables

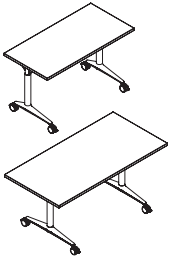

- Multipurpose folding and nesting table for active spaces
- Patented one-handed folding lever and mechanism
- Each folded Akira table adds 4½" to overall folded space when nested with another Akira table

### Available Products

#### Akira tables, options, and accessories

- Fixed and height-adjustable versions with casters or glides in L- and T-base
- Flip top nesting
- Rectangular tables in 48", 60", and 72" with L-base in 24" and 30" widths
- Trapezoid tables in 30" x 60"
- D-shape tables in 28" x 48" (L-base) and 34" x 60" (T-base)
- 90° connecting corner tops in 24", 30", and 36"
- Modesty panel option
- Horizontal wire manager option
- Vertical wire manager kit accessory
- Horizontal wire manager kit accessory

### Surface Materials

#### Top

All Coalesse Rapid10 laminate finishes are available.  
▶ See *Coalesse Rapid10 Surface Materials*, page 58.

#### Edge

6000 Black flat vinyl edge  
6086 Folkstone flat vinyl edge  
6090 Amber Cherry flat vinyl edge  
6091 Fusion Maple flat vinyl edge  
6092 Starlight flat vinyl edge  
6093 Dove Grey flat vinyl edge

#### Base

Polished Aluminum base

## E-Tables2

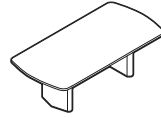

- A conference table that seamlessly integrates technology and beauty.
- The one-touch utility bay provides convenient, intuitive, and attractive connectivity to power and data outlets.
- Supports collaborative conference spaces

### Available Products

<b>E2RND48L</b>	Round, 48" diameter, with laminate drum base
<b>E2RND60L</b>	Round, 60" diameter, with laminate drum base
<b>E2C1048L</b>	Racetrack, 10"Lx48"W, with two laminate bases
<b>E2S1048L</b>	Soft radiused end, 10"Lx48"W, with two laminate bases
<b>E2R1048L</b>	Rectangular, 10"Lx48"W, with two laminate bases
<b>E2C1060L</b>	Racetrack, 10"Lx60"W, with two laminate bases
<b>E2S1060L</b>	Soft radiused end, 10"Lx60"W, with two laminate bases
<b>E2R1060L</b>	Rectangular, 10"Lx60"W, with two laminate bases
<b>E2C1248L</b>	Racetrack, 12"Lx48"W, with two laminate bases
<b>E2S1248L</b>	Soft radiused end, 12"Lx48"W, with two laminate bases
<b>E2R1248L</b>	Rectangular, 12"Lx48"W, with two laminate bases
<b>E2C9648L</b>	Racetrack, 96"L x 48"W, with two laminate bases
<b>E2S9648L</b>	Soft radiused end, 96"L x 48"W, with two laminate bases
<b>E2R9648L</b>	Rectangular, 96"L x 48"W, with two laminate bases

The following options are available on E-Table 2:

- Utility bay with hardwire base power-in, 3+0 wiring schematic.

### Surface Materials

#### Top

All Coalesse Rapid10 laminates are available.  
▶ See *Coalesse Rapid10 Surface Materials*, page 58.

#### Edge

Self-edge laminate to match flat vinyl edge: 6000 Black only  
Convex vinyl edge  
Solid bullnose wood edge  
▶ See *Coalesse Rapid10 Surface Materials*, page 58.

#### Base

Black laminate



## Runner Tables



- A comprehensive table series with folding and non-folding versions for training, seminar, and conference

### Available Products

<b>334948</b>	36" round table
<b>481949</b>	36" x 36" square table
<b>444950</b>	24" x 24" x 48" trapezoid table
<b>445952</b>	30" x 30" x 60" trapezoid table
<b>463956</b>	24" x 60" L-base non-folding table
<b>182957</b>	24" x 60" L-base folding table
<b>464956</b>	24" x 72" L-base non-folding table
<b>192957</b>	24" x 72" L-base folding table
<b>473958</b>	30" x 60" L-base non-folding table
<b>183959</b>	30" x 60" L-base folding table
<b>474958</b>	30" x 72" L-base non-folding table
<b>193959</b>	30" x 72" L-base folding table
<b>463950</b>	24" x 60" T-base non-folding table
<b>182951</b>	24" x 60" T-base folding table
<b>464950</b>	24" x 72" T-base non-folding table
<b>192951</b>	24" x 72" T-base folding table
<b>473952</b>	30" x 60" T-base non-folding table
<b>183953</b>	30" x 60" T-base folding table
<b>474952</b>	30" x 72" T-base non-folding table
<b>193953</b>	30" x 72" T-base folding table
<b>793333</b>	Dolly for rectangular folding tables only, holds 5 tables

The following options are available:

- Modesty panel on L- and T-base models.
- Casters on non-folding Runner tables. Add suffix "C" to style number to specify.
- Grommets

### Surface Materials

#### Top

All Coalesse Rapid10 laminates and wood finishes are available.

- ▶ See *Coalesse Rapid10 Surface Materials*, page 58.

#### Edge

- 6000 Black ribbed vinyl
- 6007 Woodrose ribbed vinyl
- 6009 Smoke ribbed vinyl
- 6655 Warm White ribbed vinyl

#### Base

All Coalesse Rapid10 powder coat colors are available.

- ▶ See *Coalesse Rapid10 Surface Materials*, page 58.

# Rapid10 Surface Materials

The surface materials listed below are available on the Rapid10 program if:

- they are offered on the product you are ordering, and
- they are not listed as exception in that product's section within the Coalesse Rapid10 section.

To determine if an upholstery is approved for a product, consult the Coalesse fabric database.

Contact Coalesse Customer Service Team at 800.627.6770 for inquiries.

▶ See the Coalesse specification guides for more details.

## Seating Upholstery

### Steelcase Link

Grade 6  
5A20 Burgundy  
5A21 Rust  
5A23 Green  
5A24 Blue  
5A25 Navy  
5A26 Purple  
5A27 Black  
5A28 Ocean  
5A29 Lichen  
5A30 Chamois

### Designtex Eureka Too

Grade 7  
2113-801 Jet

### Maharam Lariat

Grade 10  
440401-006 Black

## Faux Leather

### Finesse

Grade 11  
AM89 Black

## Leather

### Elmosoft Leather

Grade C  
L112 Ebony  
L139 Cinder

## Hard Materials

### Coalesse Laminates

2730 Arctic White  
2746 Black  
2826 White  
2829 Poppy Seed  
2884 Milk  
2886 Maple  
2887 Amber Cherry  
2890 Folkstone  
2891 Ingot  
2892 Ash

### Coalesse Wood Finishes

V10M Clear Maple  
V11C Clear Cherry  
V11M Natural Clear Maple  
V11W Clear Walnut  
V12C Medium Amber Cherry  
V12M Medium Maple  
V12W Medium Walnut  
V13C Dark Cherry  
V13W Black Walnut  
V14W Dark Walnut  
V31K Desert Oak  
V32K Medium Brown Oak  
V33K Medium Grey Oak  
V34K Black Oak

### Steelcase Wood Finishes

3402 Clear Cherry  
3412 Natural Cherry  
3422 Medium Cherry  
3522 Clear Maple  
3562 Linseed on Maple  
3572 Amber on Maple  
3582 Winter on Maple  
3592 Blonde on Maple  
3602 Desert Cherry  
3632 Medium Oak  
3642 Natural Oak  
3702 Clear Walnut  
3712 Natural Walnut  
3722 Dark Mahogany on Walnut  
3752 Medium Walnut  
3762 Dark Walnut  
3772 Medium Mahogany on Walnut  
3792 Black Walnut

### Powder Coat Paint

4142 Platinum Gloss  
4144 Black Gloss

### Textured Paint

7196 Midnight Brown Texture  
7197 Anthracite Texture

### Convex Vinyl Edge Band

6000 Black  
6007 Woodrose  
6009 Smoke  
6655 Warm White

### Flat Vinyl Edge

6000 Black  
6086 Folkstone  
6090 Amber Cherry  
6091 Fusion Maple  
6092 Starlight  
6093 Dove Grey

### Runner Ribbed Vinyl Edge

6000 Black Ribbed Vinyl  
6007 Woodrose Ribbed Vinyl  
6009 Smoke Ribbed Vinyl  
6655 Warm White Ribbed Vinyl

### Glass

AC Absolute Clear

### Plastic

400 Black  
6400 Black  
6427 Grey

## Exceptions Surface Materials

### Not Available

- Customer's Own Laminate
- Customer's Own Leather
- Customer's Own Material
- Stain-to-Match
- Special Color Match Leather



# Trademark List

- ® The following are registered trademarks for products of Steelcase Inc. or one of its related corporate entities: 4 o'clock, 900 Series, à la carte, Airtouch, Ally, Amia, Answer, Archipelago, Avenir, Ballet, Bix, Brayton International, Cachet, Canopy, Canto, Chancellor, Coalesse, Confidante, Context, Convene, CopyCam, Criterion, Crushed Can, Currency, dash, Designtex, Details, Detour, Drive, Elective Elements, Ellipse, Ember Chrome, Emerge, E-Table 2, FYI, Garland, Gentry, Ginkgo Biloba, Groupwork, Ideo, Jacket, Jenny, Jersey, Kart, Kick, LaCosta, Leap, Let's B, LiveBack, Max-Stacker, media:scape, Metro, Migrations, Mitra, Montage, Nurture, Oriana, Parade, Pathways, PCT, Permiso, Player, PolyVision, Portal, Power Pincher, Progeny, Protégé, R2, Rally, Relevant, Reply, Rizzi Arc, Sensor, Series 9000, Siento, Sieste, Sine, Softcare, Springboard, Steelcase, Steelcase Design Partnership, Stella, Stow Davis, Swathmore, TeamWork, Technique, Texpress, Think, Thunder, Topo, Train, Turnstone, Underline, Unison, Vecta, Viridian, Walden, Werndl, and X-Stack.
- ® The following registered trademarks are under license from AWI Licensing Company, Dover, DE: SoundScapes, DuraBrite, BioBlock, and Armstrong.
- ® The following registered trademarks are under license from Byrne Electrical, Rockford, MI: Interport, Mini-Port, Axil Z, and Ellora.
- ® The following is a registered trademark of DuPont, Wilmington, DE: Corian.
- ® The following is a registered trademark of Genlyte Thomas Company, Louisville, KY: Lightolier.
- ® The following is a registered trademark of Hilti Corporation, FL-9494 Schaan, Principality of Liechtenstein: Hilti.
- ® The following is a registered trademark of Leviton Manufacturing Company, Little Neck, NY: Decora.
- ® The following is a registered trademark of Mechanical Plastics Corp, Elmsford, NY: Toggler.
- ® The following is a registered trademark of Microsoft Corporation, Redmond, WA: Microsoft.
- ® The following is a registered trademark of Panduit Corporation, Lockport, IL: Panduit.
- ® The following is a registered trademark of Trav (Press), Cuneo, Italy: Assisa.
- ® The following is a registered trademark of Virtual Ink, Boston, MA: mimioActive.
- ® The following registered trademarks are under license from Wilkhahn Furniture Products: Avera, Senzo, Versal, and Wilkhahn FS.
- ® The following is a registered trademark of Wilsonart International, Temple, TX: Chemsurf.

- ® The following is a registered trademark of Wiremold, West Hartford, CT: Wiremold.
- ® The following is a registered trademark of EMU Group S.P.A., Perugia, Italy: Emu.
- ™ The following are trademarks for products of Steelcase Inc. or one of its related corporate entities: Access, Active/Passive Shelf, Ainsley, Akira, Alcove, Alerion, aLight, Amaris, American Elect, American Tradition, ap40, Arbor, Arriva, Asana, Ascot, Aspekt, Astor, Await, Bira, Bivi, Bottomline, Brook, Buoy, Burton, c:scape, Calla, Calm, Camber, Campfire, Capa, Cappuccino, Cesar, Chester, Chord, Circa, Clarendon, Classic Rectangular, cobi, Collaboration, Community, Company, Convey, Cortex, Coupe, Crea, Crew, Cura, Cypress, Davenport, Dearborn, Deck, Déjà, Denizen, Denska, Derby, Divisio, Donovan, Dune, Duo, e<sup>3</sup>, e<sup>3</sup> ceramicsteel, e<sup>3</sup> environmental ceramicsteel, Echo, Edge, Elsa, Empath, Empress, Enea, ēno, EnSync, Enviro, Escapade, Exchange, Exponents, Field, Flat Top, FlexFrame, Flip Top, Flute, Folio, FrameOne, FreeFlow, Frontier, Galilei, Gesture, Ginger, Ginkgo, Go Wall, Grip, Groove, Hatchback, Hawthorne, Hitch, Host Collection, Hosu, Huddleboard, i2i, Impact, Indy, InfoLink, IOS, I-Solve, Jack, Jarrah, Jetty, Juice, Kami, Kast, Kathryn, Lagunitas, Lark, L'Attitude, LearnLab, Leela, Lincoln, Linden, LiveSeat, Loria, Lyric, Malibu, Malibu Too, Mansfield, Marathon, Martini, Mason, Masque, Millbrae, Mineral, Mingle, Mystic, Mystic Metal, Mystic Wood, Montreal, Move, Nadia, Neighbor, nesso, Nickel, Nikko, Nod, Node, Norfolk, Ontrak, Oom, Opus, Orchid, Outlook Collection, Ovation, Paloma, Paperflo, Parliament, Pasio, Passerelle, Patriarch, Payback, Peek, Pile File, Pisa, Pool, PUCK, QiVi, Quba, Rave, Reed, Regard, Relay, Reunion, Ripple, Riser, Rocco, Rocky, RoomWizard, Runner, Satellite, Sawyer, ScapeSeries, Senti, Sentinel, Senza, Sequoia, Session, ShareLink, Shield, Sidewalk, Skylar, Slumber, Smoke, Snug, Soft Leaf, Sonata, Sorrel, SOTO, Stationkits, Stiletto, Surprise!, Switch, Symphony, Sync, TagWizard, Tava, TeamStudio, TeamTheater, Tenaro, Terrazzo, Theorem, Thread, Topaz, Touchdown, Tour, Tower Too, Trees, Trillium, Trolly, tX2, U-Free, Uno, V.I.A., Verb, Verge, Victor2, Visalia, Waldorf, Woodruff, Workspring, and X-tenz.
- ™ The following is a trademark of Microsoft Corporation, Redmond, WA: Windows.
- ™ The following is a trademark of Rodman Industries, Inc., Oconomowoc, WI: ResinCore1.
- ™ The following is a trademark of Ultrafabrics, LLC, Elmsford, NY: Ultraleather.
- ™ The following trademarks are under license from Wilkhahn Furniture products: Cana, Linus, Logon, Picto, Range, Stitz, Thema, Timetable, and Tubis.
- ™ The following is a trademark of MBDC, Charlottesville, VA: Cradle to Cradle and C2C.

- ™ The following trademarks are under license from Walter Knoll: Andoo, Bob, Lazlo, Lox, Ribbon, and Together.
  - ™ The following trademarks are under license from PP Möbler: Bar and Flag Halyard.
  - ™ The following trademarks are under license from Viccarbe: Davos, Holy Day, Last Minute, RS, and Wrapp.
  - ™ The following trademarks are under license from Carl Hansen: Elbow, Paddle, Shell, Wing, and Wishbone.
  - ™ The following trademarks are under license from Cambridge Sound Management, LLC, Cambridge, MA: QtPro Soundmasking, Qt Quiet Technology, and Sonet Qt.
  - ™ The following is a trademark of Electri-Cable Assemblies, Shelton, CT: Interact.
- Trademarks used here in are the property of Steelcase, Inc. or of their respective owners.*